

Buck Converter - DC-DC

1.5 MHz, 600 mA

NCP1521B

The NCP1521B step-down DC-DC converter is a monolithic integrated circuit optimized for portable applications powered from one cell Li-Ion or three cell Alkaline/NiCd/NiMH batteries. The part, available in adjustable output voltage versions ranging from 0.9 V to 3.9 V, is able to deliver up to 600 mA. It uses synchronous rectification to increase efficiency and reduce external part count. The device also has a built-in 1.5 MHz (nominal) oscillator which reduces component size by allowing smaller inductors and capacitors. Automatic switching PWM/PFM mode offers improved system efficiency.

Additional features include integrated soft-start, cycle-by-cycle current limiting and thermal shutdown protection. The NCP1521B is available in a space saving, low profile TSOP5 package.

Features

- Up to 96% Efficiency
- Best-In-Class Ripple, including PFM Mode
- Sources up to 600 mA
- 1.5 MHz Switching Frequency
- Adjustable Output Voltage from 0.9 V to 3.9 V
- Synchronous Rectification for Higher Efficiency
- 2.7 V to 5.5 V Input Voltage Range
- Low Quiescent Current
- Shutdown Current Consumption of 0.3 μ A
- Thermal Limit Protection
- Short Circuit Protection
- All Pins are Fully ESD Protected
- This is a Pb-Free Device

Typical Applications

- Cellular Phones, Smart Phones and PDAs
- Digital Still/Video Cameras
- MP3 Players and Portable Audio Systems
- Wireless and DSL Modems
- Portable Equipment
- USB Powered Devices

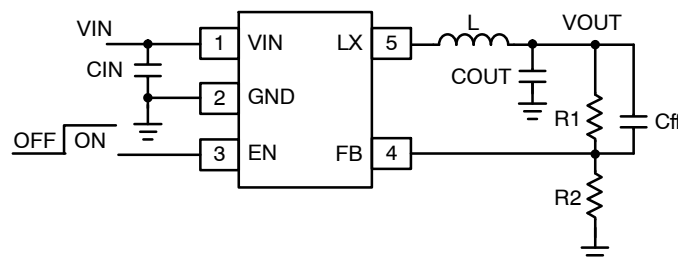
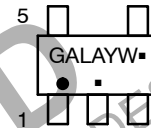

Figure 1. Typical Application – TSOP-5



TSOP-5
SN SUFFIX
CASE 483

MARKING DIAGRAM



GAL = Specific Device Code
A = Assembly Location
Y = Year
W = Work Week
▪ = Pb-Free Package
(Note: Microdot may be in either location)

ORDERING INFORMATION

Device	Package	Shipping†
NCP1521BSNT1G	TSOP-5 (Pb-Free)	3000/Tape & Reel

†For information on tape and reel specifications, including part orientation and tape sizes, please refer to our Tape and Reel Packaging Specification Brochure, [BRD8011/D](#).

NCP1521B

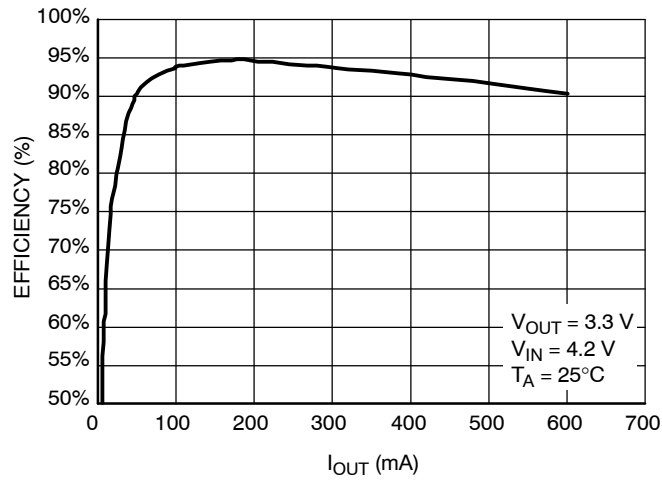

Figure 2. Efficiency vs. Output Current

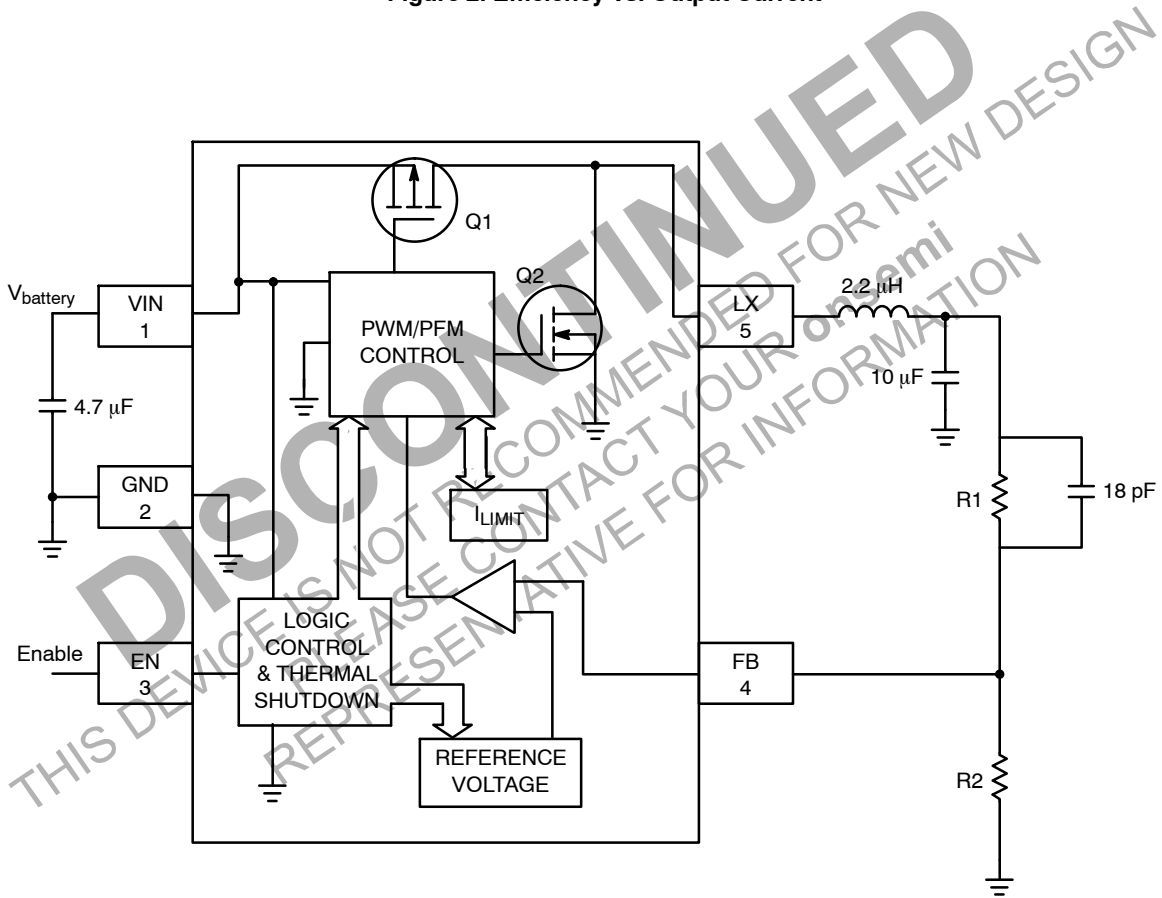

Figure 3. Simplified Block Diagram

NCP1521B

PIN FUNCTION DESCRIPTION

Pin No.	Pin Name	Type	Description
1	VIN	Analog / Power Input	Power supply input for the PFET power stage, analog and digital blocks. The pin must be decoupled to ground by a 4.7 μ F ceramic capacitor.
2	GND	Analog / Power Ground	This pin is the GND reference for the NFET power stage and the analog section of the IC. The pin must be connected to the system ground.
3	EN	Digital Input	Enable for switching regulators. This pin is active HIGH and is turned off by logic LOW on this pin. Do not let this pin float.
4	FB	Analog Input	Feedback voltage from the output of the power supply. This is the input to the error amplifier.
5	LX	Analog Output	Connection from power MOSFETs to the Inductor.

PIN CONNECTIONS

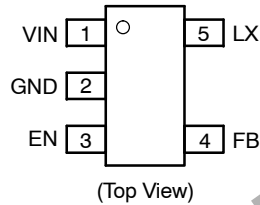

Figure 4. Pin Connections – TSOP5

MAXIMUM RATINGS

Rating	Symbol	Value	Unit
Minimum Voltage All Pins	V_{min}	-0.3	V
Maximum Voltage All Pins (Note 2)	V_{max}	7.0	V
Maximum Voltage EN, FB, LX	V_{max}	VIN + 0.3	V
Thermal Resistance, Junction -to-Air (with Recommended Soldering Footprint)	$R_{\theta JA}$	300	$^{\circ}$ C/W
Operating Ambient Temperature Range	T_A	-40 to 85	$^{\circ}$ C
Storage Temperature Range	T_{stg}	-55 to 150	$^{\circ}$ C
Junction Operating Temperature	T_j	-40 to 125	$^{\circ}$ C
Latch-up Current Maximum Rating ($T_A = 85^{\circ}$ C) (Note 4)	Lu	± 100	mA
ESD Withstand Voltage (Note 3) Human Body Model Machine Model	V_{esd}	2.0 200	kV V
Moisture Sensitivity Level (Note 5)	MSL	1	per IPC

Stresses exceeding those listed in the Maximum Ratings table may damage the device. If any of these limits are exceeded, device functionality should not be assumed, damage may occur and reliability may be affected.

- Maximum electrical ratings are defined as those values beyond which damage to the device may occur at $T_A = 25^{\circ}$ C.
- According to JEDEC standard JESD22-A108B.
- This device series contains ESD protection and exceeds the following tests:
Human Body Model (HBM) per JEDEC standard: JESD22-A114.
Machine Model (MM) per JEDEC standard: JESD22-A115.
- Latchup current maximum rating per JEDEC standard: JESD78.
- JEDEC Standard: J-STD-020A.

NCP1521B

ELECTRICAL CHARACTERISTICS (Typical values are referenced to $T_A = +25^\circ\text{C}$, Min and Max values are referenced -40°C to $+85^\circ\text{C}$ ambient temperature, unless otherwise noted, operating conditions $V_{IN} = 3.6\text{ V}$, $V_{OUT} = 1.2\text{ V}$, unless otherwise noted.)

Rating	Pin	Symbol	Min	Typ	Max	Unit
--------	-----	--------	-----	-----	-----	------

VIN PIN

Input Voltage Range	1	V_{IN}	2.7	–	5.5	V
Quiescent Current, PFM No Switching	1	$I_{q\text{ ON}}$	–	30	45	μA
Standby Current, EN Low	1	$I_{q\text{ OFF}}$	–	0.2	1.5	μA
Undervoltage Lockout (V_{IN} Falling)	1	V_{UVLO}	2.2	2.4	2.55	V

EN PIN

Positive going Input High Voltage Threshold, EN0 Signal	3	V_{IH}	1.2	–	–	V
Negative going Input High Voltage Threshold, EN0 Signal	3	V_{IL}	–	–	0.4	V
EN High Input Current, EN = 3.6 V	3	I_{ENH}	–	2.0	–	μA

OUTPUT

Output Voltage Accuracy (Note 6) Ambient Temperature Overtemperature Range		V_{OUT}	– –3.0	± 1.0 ± 2.0	– 3.0	%
Feedback Voltage Threshold	4	V_{FB}	–	0.6	–	V
Minimum Output Voltage		V_{OUT}	–	0.9	–	V
Maximum Output Voltage		V_{OUT}	–	3.3	–	V
Maximum Output Voltage for USB or 5 V Rail Powered Applications V_{IN} from 4.3 V to 5.5 V (Note 7)		V_{OUT}	–	3.9	–	V
Output Voltage load regulation Overtemperature $I_{OUT} = 100\text{ mA}$ to 600 mA		V_{OUT}	–	0.0005 –	– –	%/mA
Load Transient Response, Rise/Falltime $1\ \mu\text{s}$ 10 mA to 100 mA Load Step 200 mA to 600 mA Load Step		V_{OUT}	– –	35 80	– –	mV
Output Voltage Line Regulation, $I_{OUT} = 100\text{ mA}$, $V_{IN} = 2.7\text{ V}$ to 5.5 V		V_{OUT}	–	0.05	–	%
Line Transient Response, $I_{OUT} = 100\text{ mA}$, 3.6 V to 3.0 V Line Step (Falltime=50 μs)		V_{OUT}	–	6	–	mV _{PP}
Output Voltage Ripple, $I_{OUT} = 300\text{ mA}$ (PWM Mode)		V_{OUT}	–	2.0	–	mV
Output Voltage Ripple, $I_{OUT} = 0\text{ mA}$ (PFM Mode)		V_{OUT}	–	8.0	–	mV
Peak Inductor Current	5	I_{LIM}	–	1200	–	mA
Oscillator Frequency	5	F_{OSC}	1.3	1.5	1.8	MHz
Duty Cycle	5	–	–	–	100	%
Soft-Start Time		T_{START}	–	320	500	μs
Thermal Shutdown Threshold		T_{SD}	–	160	–	$^\circ\text{C}$
Thermal Shutdown Hysteresis		T_{SDH}	–	25	–	$^\circ\text{C}$

POWER SWITCHES

P-Channel On-Resistance		RL_{xH}	–	400	–	$\text{m}\Omega$
N-Channel On-Resistance		RL_{xL}	–	400	–	$\text{m}\Omega$
P-Channel Leakage Current		I_{LeakH}	–	0.05	–	μA
N-Channel Leakage Current		I_{LeakL}	–	0.01	–	μA

6. The overall output voltage tolerance depends upon the accuracy of the external resistor ($R1$, $R2$).

7. Functionality guaranteed per design and characterization, see chapter "USB or 5 V Rail Powered Applications".

TABLE OF GRAPHS

Typical Characteristics for Step-down Converter			Figure
I_{STB}	Standby Current	vs. Input Voltage	5
I_q	Quiescent Current, PFM No Switching	vs. Input Voltage	6
V_{OUT}	Output Voltage Accuracy	vs. Temperature	7 and 8
Eff	Efficiency	vs. Output Current	9, 10, 11 and 27
Freq	Switching Frequency	vs. Input Voltage	12
V_{OUT}	Soft-Start	vs. Time	13
V_{OUT}	Short Circuit Protection	vs. Time	14
V_{OUT}	Line Regulation	vs. Input Voltage	15 and 16
V_{OUT}	Line Transient	vs. Time	17 and 18
V_{OUT}	Load Regulation	vs. Output Current	19, 20 and 28
V_{OUT}	Load Transient	vs. Time	21, 22, 23 and 24

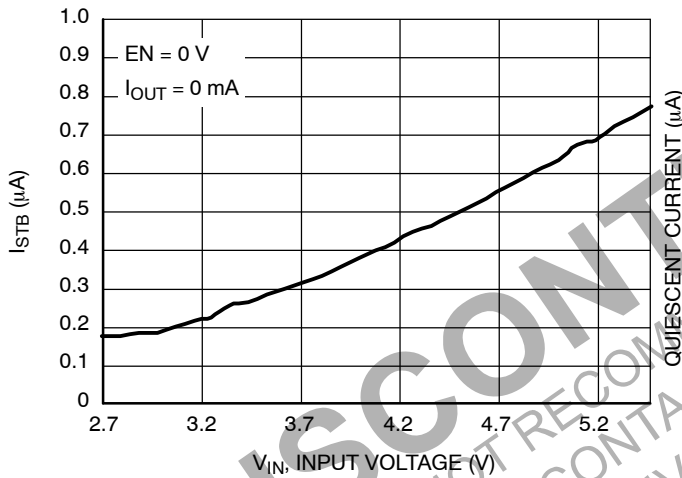

Figure 5. Shutdown Current vs. Supply Voltage

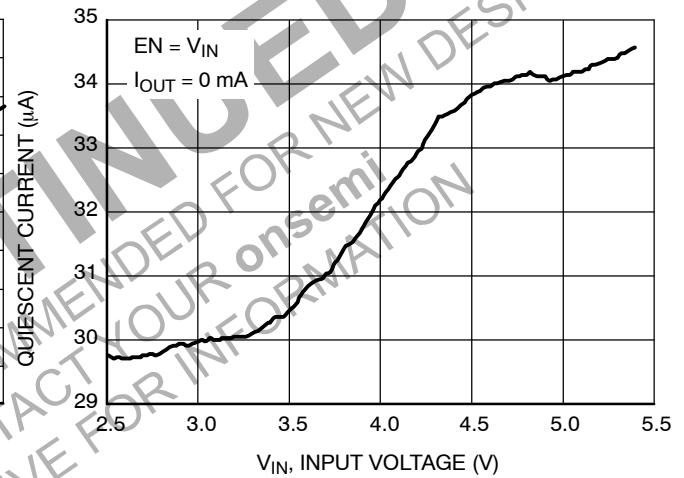

Figure 6. Quiescent Current PFM No Switching vs. Supply Voltage

NCP1521B

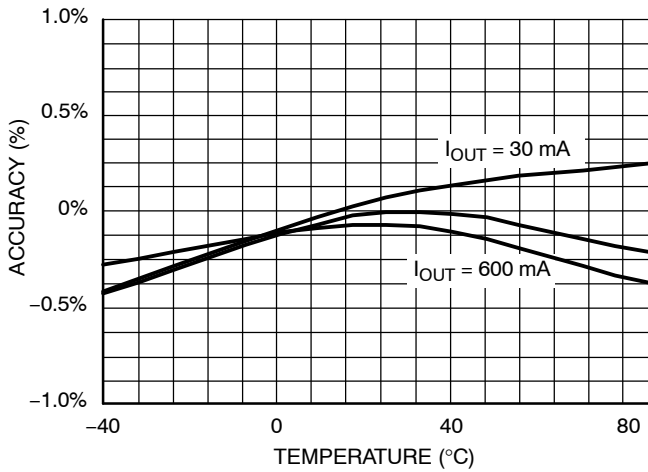

Figure 7. Output Voltage Accuracy vs. Temperature
($V_{IN} = 3.6\text{ V}$, $V_{OUT} = 1.2\text{ V}$)

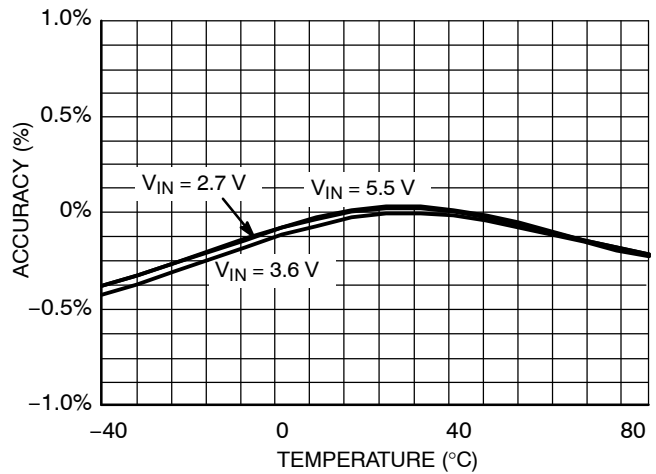

Figure 8. Output Voltage Accuracy vs. Temperature
($V_{OUT} = 1.2\text{ V}$, $I_{OUT} = 200\text{ mA}$)

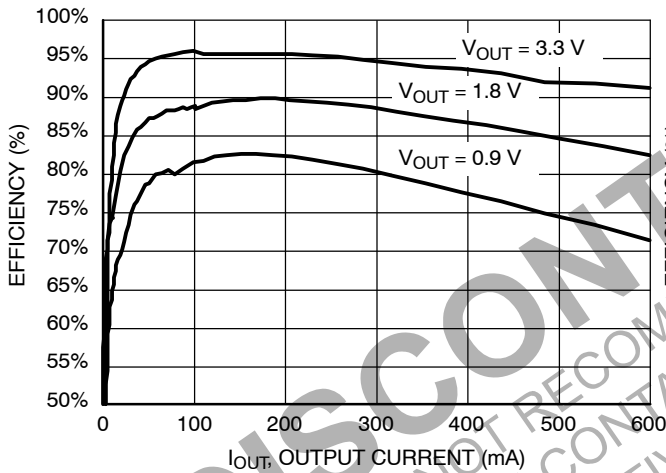

Figure 9. Efficiency vs. Output Current
($V_{IN} = 3.6\text{ V}$, $T_A = 25^\circ\text{C}$)

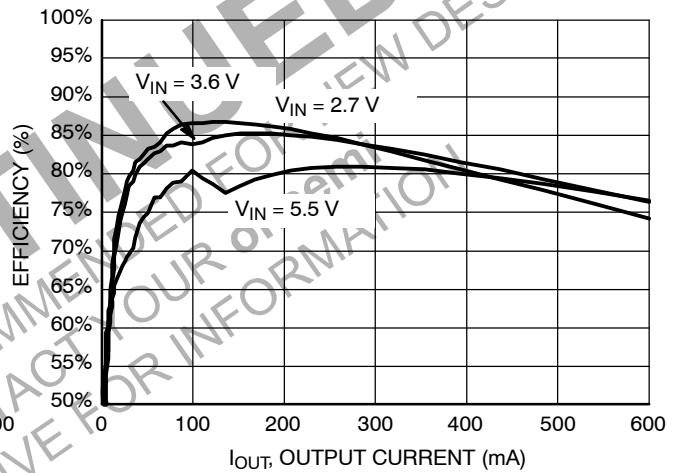

Figure 10. Efficiency vs. Output Current
($V_{OUT} = 1.2\text{ V}$, $T_A = 25^\circ\text{C}$)

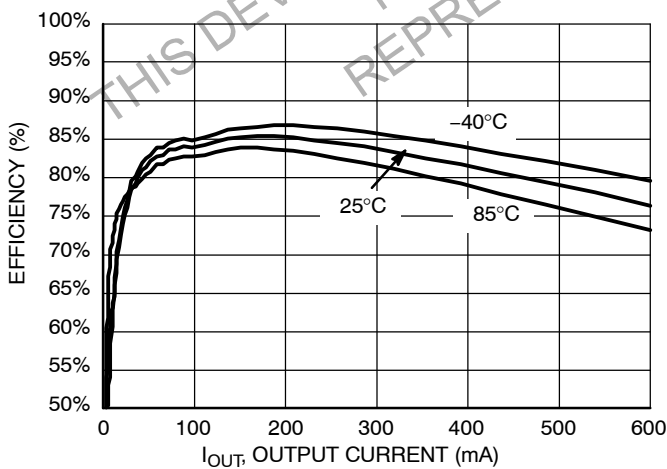

Figure 11. Efficiency vs. Output Current
($V_{IN} = 3.6\text{ V}$, $V_{OUT} = 1.2\text{ V}$)

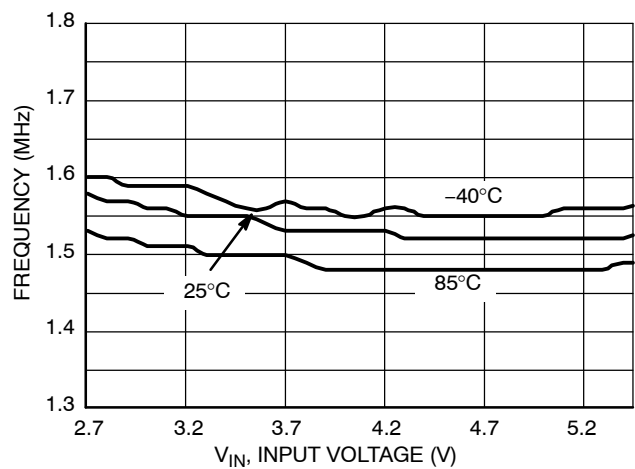

Figure 12. Switching Frequency vs. Input Voltage
($V_{OUT} = 1.2\text{ V}$, $I_{OUT} = 300\text{ mA}$)

NCP1521B

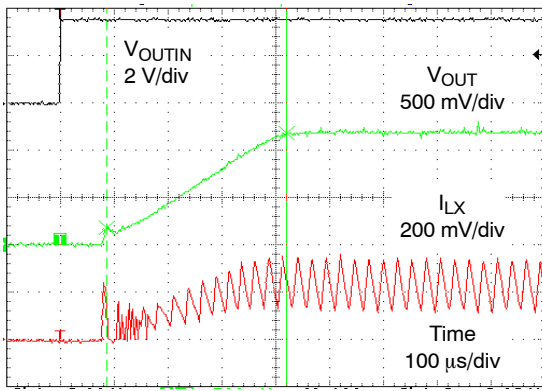

Figure 13. Typical Soft-Start
 $(V_{IN} = 3.6 \text{ V}, V_{OUT} = 1.2 \text{ V}, I_{OUT} = 250 \text{ mA})$

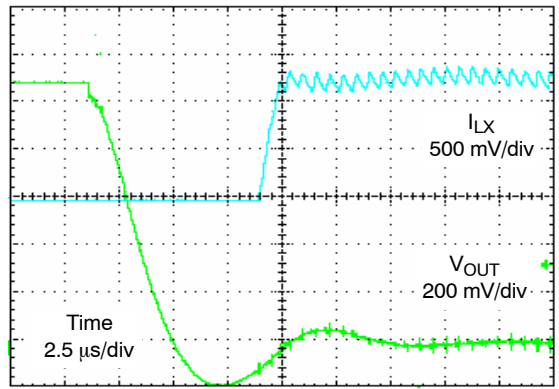

Figure 14. Short-Circuit Protection
 $(V_{IN} = 3.6 \text{ V}, V_{OUT} = 1.2 \text{ V})$

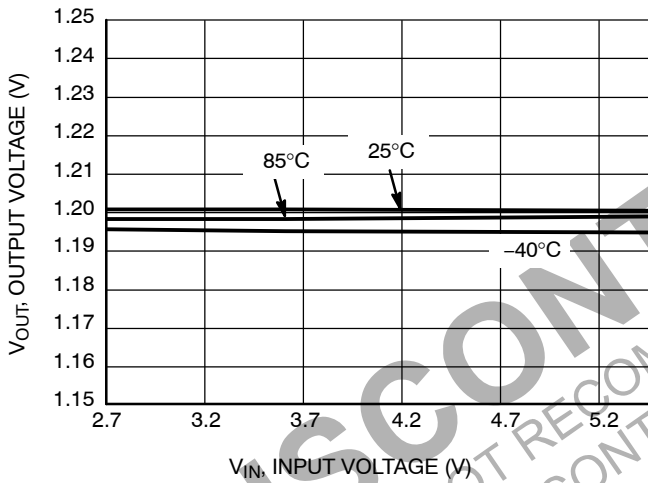

Figure 15. Line Regulation
 $(V_{OUT} = 1.2 \text{ V}, I_{OUT} = 100 \text{ mA})$

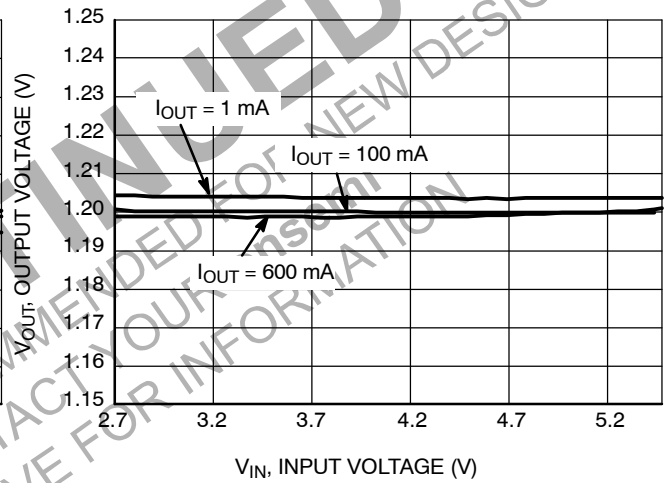

Figure 16. Line Regulation
 $(V_{OUT} = 1.2 \text{ V}, T_A = 25^\circ\text{C})$

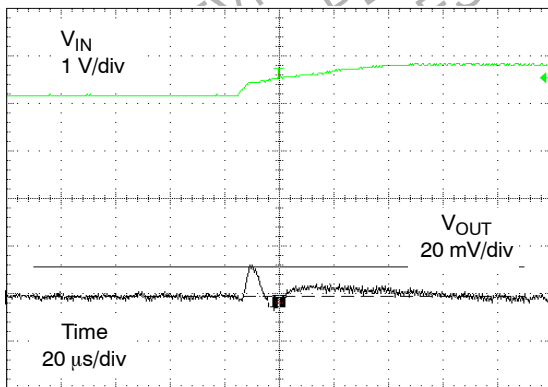

Figure 17. 3.0 V to 3.6 V Line Transient
 $(\text{Risetime} = 50 \mu\text{s}, V_{OUT} = 1.2 \text{ V}, I_{OUT} = 100 \text{ mA}, T_A = 25^\circ\text{C})$

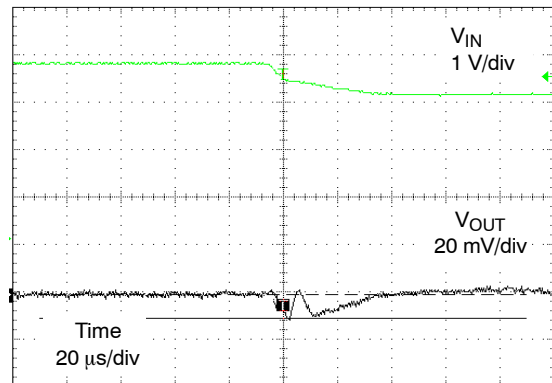

Figure 18. 3.6 V to 3.0 V Line Transient
 $(\text{Risetime} = 50 \mu\text{s}, V_{OUT} = 1.2 \text{ V}, I_{OUT} = 100 \text{ mA}, T_A = 25^\circ\text{C})$

NCP1521B

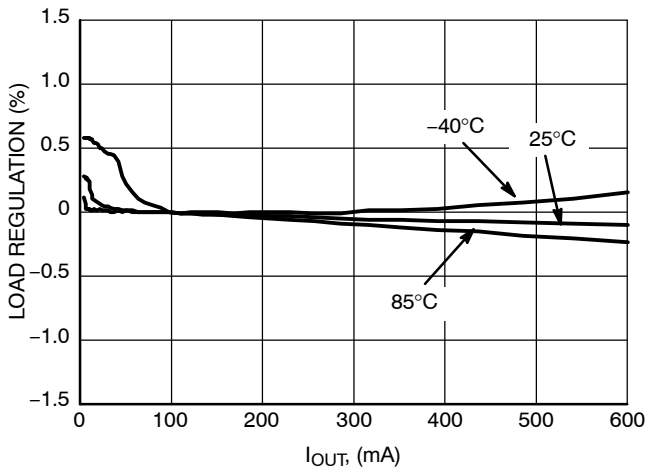

Figure 19. Load Regulation
($V_{IN} = 3.6\text{ V}$, $V_{OUT} = 1.2\text{ V}$)

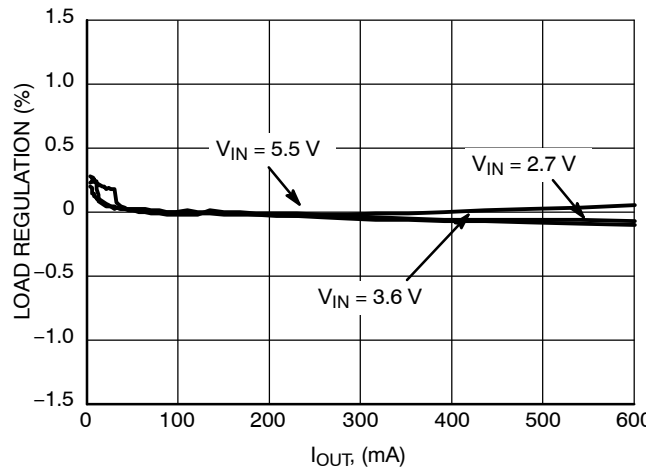

Figure 20. Load Regulation
($V_{OUT} = 1.2\text{ V}$, $T_A = 25^\circ\text{C}$)

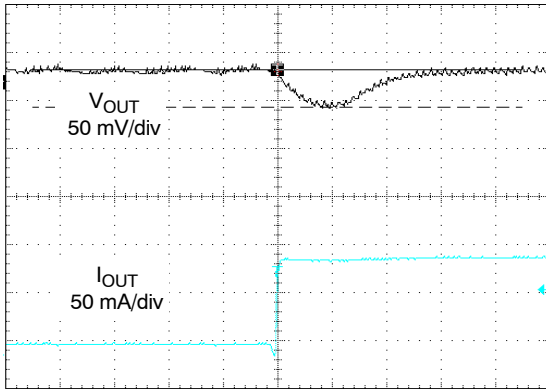

Figure 21. 10 mA to 100 mA Load Transient
($V_{IN} = 3.6\text{ V}$, $V_{OUT} = 1.2\text{ V}$, $T_A = 25^\circ\text{C}$)

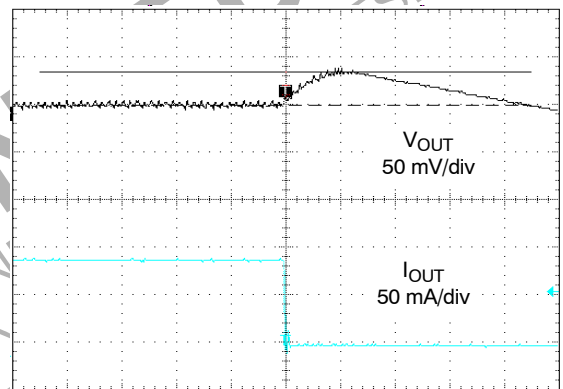

Figure 22. 100 mA to 10 mA Load Transient
($V_{IN} = 3.6\text{ V}$, $V_{OUT} = 1.2\text{ V}$, $T_A = 25^\circ\text{C}$)

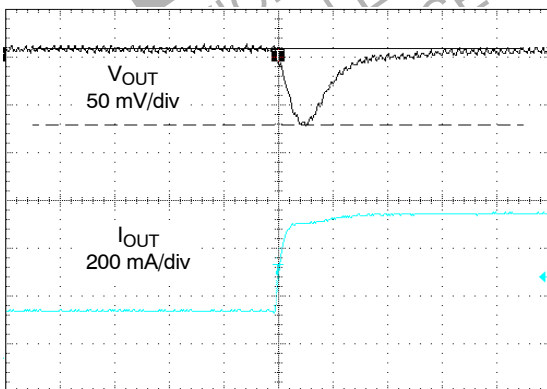

Figure 23. 200 mA to 600 mA Load Transient
($V_{IN} = 3.6\text{ V}$, $V_{OUT} = 1.2\text{ V}$, $T_A = 25^\circ\text{C}$)

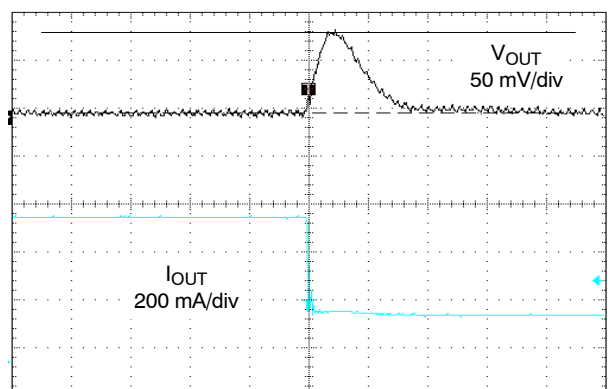

Figure 24. 600 mA to 200 mA Load Transient
($V_{IN} = 3.6\text{ V}$, $V_{OUT} = 1.2\text{ V}$, $T_A = 25^\circ\text{C}$)

OPERATION DESCRIPTION

Overview

The NCP1521B uses a constant frequency, current mode step-down architecture. Both the main (P-Channel MOSFET) and synchronous (N-Channel MOSFET) switches are internal.

It delivers a constant voltage from either a single Li-Ion or three cell NiMH/NiCd battery to portable devices such as cell phones and PDA. The output voltage is set by an external resistor divider. The NCP1521B sources at least 600 mA, depending on external components chosen.

The NCP1521B works with two modes of operation; PWM/PFM depending on the current required. In PWM mode, the device can supply voltage with a tolerance of $\pm 3\%$ and 90% efficiency or better. Lighter load currents cause the device to automatically switch into PFM mode for reduced current consumption and extended battery life.

Additional features include soft-start, undervoltage protection, current overload protection, and thermal shutdown protection. As shown in Figure 1, only six external components are required. The part uses an internal reference voltage of 0.6 V. It is recommended to keep the part in shutdown mode until the input voltage is 2.7 V or higher.

PWM Operating Mode

In this mode, the output voltage of the NCP1521B is regulated by modulating the on-time pulse width of the main switch Q1 at a fixed frequency of 1.5 MHz. The switching of the PMOS Q1 is controlled by a flip-flop driven by the internal oscillator and a comparator that compares the error signal from an error amplifier with the sum of the sensed current signal and compensation ramp. This driver switches ON and OFF the upper side transistor (Q1) and switches the lower side transistor (Q2) in either ON state or in current source mode. At the beginning of each cycle, the main switch Q1 is turned ON while Q2 is in its current source mode by the rising edge of the internal oscillator clock. The inductor current ramps up until the sum of the current sense signal and compensation ramp becomes higher than the error voltage amplifier. Once this has occurred, the PWM comparator resets the flip-flop, Q1 is turned OFF and the synchronous switch Q2 is turned in its ON state. Q2 replaces the external Schottky diode to reduce the conduction loss and improve the efficiency. To avoid overall power loss, a certain amount of dead time is introduced to ensure Q1 is completely turned OFF before Q2 is being turned ON.

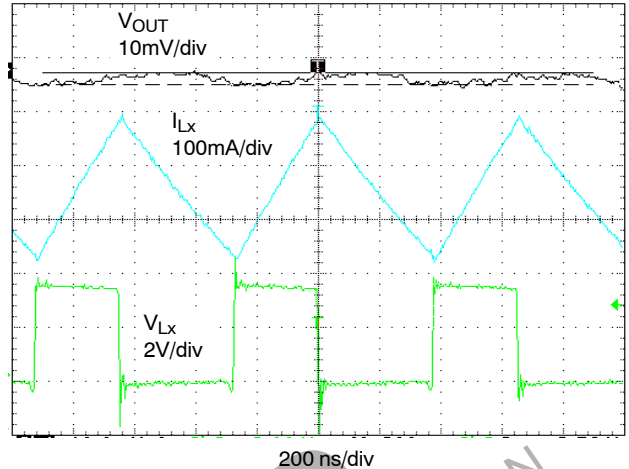

Figure 25. PWM Switching Waveform
($V_{IN} = 3.6\text{ V}$, $V_{OUT} = 1.2\text{ V}$, $I_{OUT} = 600\text{ mA}$)

PFM Operating Mode

Under light load conditions, the NCP1521B enters in low current PFM mode operation to reduce power consumption. The output regulation is implemented by pulse frequency modulation. If the output voltage drops below the threshold of PFM comparator, a new cycle will be initiated by the PFM comparator to turn on the switch Q1. Q1 remains ON during the minimum on time of the structure while Q2 is in its current source mode. The peak inductor current depends upon the drop between input and output voltage. After a short dead time delay where Q1 is switched OFF, Q2 is turned in its ON state. The negative current detector will detect when the inductor current drops below zero and sends the signal to turn Q2 to current source mode to prevent a too large deregulation of the output voltage. When the output voltage falls below the threshold of the PFM comparator, a new cycle starts immediately.

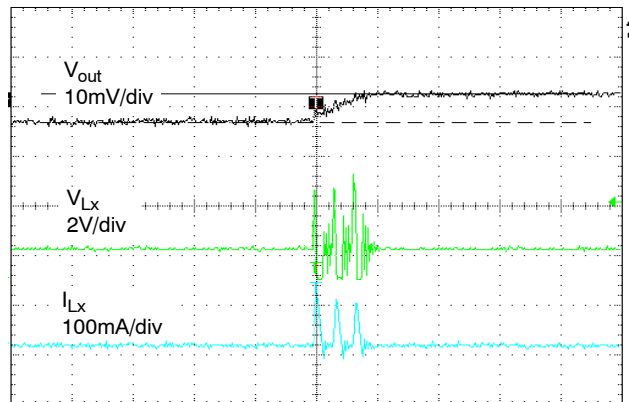

Figure 26. PFM Mode Switching Waveform
($V_{IN} = 3.6\text{ V}$, $V_{OUT} = 1.2\text{ V}$, $I_{OUT} = 0\text{ mA}$)

Cycle-by-Cycle Current Limitation

From the block diagram (Figure 3), an I_{LIM} comparator is used to realize cycle-by-cycle current limit protection. The comparator compares the LX pin voltage with the reference voltage, which is biased by a constant current. If the inductor current reaches the limit, the I_{LIM} comparator detects the LX voltage falling below the reference voltage and releases the signal to turn off the switch Q1. The cycle-by-cycle current limit is set at 1200 mA (nom).

Short Circuit Protection

When the output is shorted to ground, the device limits the inductor current. The duty-cycle is minimum and the consumption on the input line is 300 mA (Typ). When the short circuit condition is removed, the device returns to the normal mode of operation.

Soft-Start

The NCP1521B uses soft-start (300 μ s Typ) to limit the inrush current when the device is initially enabled. Soft-start is implemented by gradually increasing the reference voltage until it reaches the full reference voltage. During startup, a pulsed current source charges the internal soft-start capacitor to provide gradually increasing reference voltage. When the voltage across the capacitor ramps up to the nominal reference voltage, the pulsed current source will be switched off and the reference voltage will switch to the regular reference voltage.

Shutdown Mode

Forcing this pin to a voltage below 0.4 V will shut down the IC. In shutdown mode, the internal reference, oscillator and most of the control circuitries are turned off. Therefore, the typical current consumption will be 0.3 μ A (typical value). Applying a voltage above 1.2 V to EN pin will enable the device for normal operation. The typical threshold is around 0.7 V. The device will go through soft-start to normal operation.

Thermal Shutdown

Internal Thermal Shutdown circuitry is provided to protect the integrated circuit in the event that the maximum junction temperature is exceeded. If the junction temperature exceeds 160°C, the device shuts down. In this mode switch Q1 and Q2 and the control circuits are all turned off. The device restarts in soft-start after the temperature drops below 135°C. This feature is provided to prevent catastrophic failures from accidental device overheating, and it is not intended as a substitute for proper heatsinking.

Low Dropout Operation

The NCP1521B offers a low input to output voltage difference. The NCP1521B can operate at 100% duty cycle. In this mode the PMOS (Q1) remains completely on.

The minimum input voltage to maintain regulation can be calculated as:

$$V_{IN(min)} = V_{OUT(max)} + (I_{OUT} \times (R_{DS(on)} + R_{INDUCTOR})) \quad (\text{eq. 1})$$

- V_{OUT} : Output Voltage (Volts)
- I_{OUT} : Max Output Current
- $R_{DS(on)}$: P-Channel Switch $R_{DS(on)}$
- $R_{INDUCTOR}$: Inductor Resistance (DCR)

USB or 5 V Rail Powered Applications

For USB or 5 V rail powered applications, NCP1521B is able to supply voltages up to 3.9 V, 600 mA, operating in PWM mode only, with high efficiency (Figure 27), low output voltage ripple and good load regulation results over all current range (Figure 28).

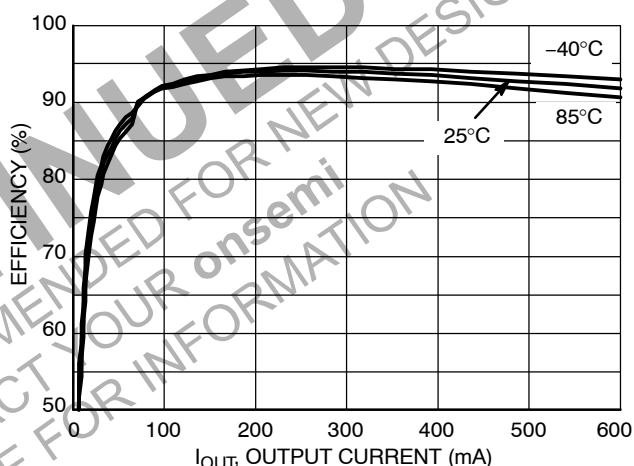

Figure 27. Efficiency vs. Output Current
($V_{IN} = 5.0$ V, $V_{OUT} = 3.9$ V)

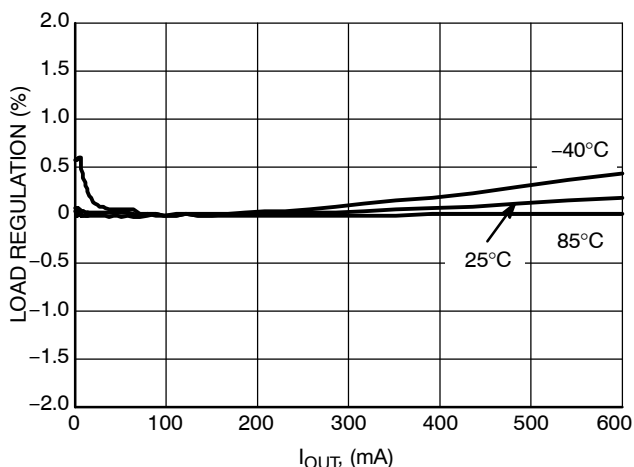

Figure 28. Load Regulation
($V_{IN} = 5.0$ V, $V_{OUT} = 3.9$ V)

APPLICATION INFORMATION

Output Voltage Selection

The output voltage is programmed through an external resistor divider connected from V_{OUT} to FB then to GND. For low power consumption and noise immunity, the resistor from FB to GND (R2) should be in the [100 k–600 k] range. If R2 is 200 k given the V_{FB} is 0.6 V, the current through the divider will be 3.0 μA.

The formula below gives the value of V_{OUT}, given the desired R1 and the R1 value:

$$V_{OUT} = V_{FB} \times \left(1 + \frac{R1}{R2}\right) \quad (\text{eq. 2})$$

- V_{OUT}: Output Voltage (Volts)
- V_{FB}: Feedback Voltage = 0.6 V
- R1: Feedback Resistor from V_{OUT} to FB
- R2: Feedback Resistor from FB to GND

Input Capacitor Selection

In PWM operating mode, the input current is pulsating with large switching noise. Using an input bypass capacitor can reduce the peak current transients drawn from the input supply source, thereby reducing switching noise significantly. The capacitance needed for the input bypass capacitor depends on the source impedance of the input supply.

The maximum RMS current occurs at 50% duty cycle with maximum output current, which is I_{out max}/2.

For NCP1521B, a low profile, low ESR ceramic capacitor of 4.7 μF should be used for most of the cases. For effective bypass results, the input capacitor should be placed as close as possible to the V_{IN} pin.

Table 1. List of Input Capacitor

Murata	GRM188R60J475KE
	GRM21BR71C475KA
Taiyo Yuden	JMK212BY475MG
TDK	C2012X5ROJ475KB
	C1632X5ROJ475KT

Output L–C Filter Design Considerations

The NCP1521B operates at 1.5 MHz frequency and uses current mode architecture. The correct selection of the output filter ensures good stability and fast transient response.

Due to the nature of the buck converter, the output L–C filter must be selected to work with internal compensation. For NCP1521B, the internal compensation is internally fixed and it is optimized for an output filter of L = 2.2 μH and C_{OUT} = 10 μF.

The corner frequency is given by:

$$f_c = \frac{1}{2\pi\sqrt{L} \times C_{OUT}} = \frac{1}{2\pi\sqrt{2.2 \mu\text{H}} \times 10 \mu\text{F}} = 34 \text{ kHz} \quad (\text{eq. 3})$$

The device is intended to operate with inductance values between 1.0 μH and maximum of 4.7 μH.

If the corner frequency is moved, it is recommended to check the loop stability depending on the output ripple voltage accepted and output current required. For lower frequency, the stability will be increased; a larger output capacitor value could be chosen without critical effect on the system. On the other hand, a smaller capacitor value increases the corner frequency and it should be critical for the system stability. Take care to check the loop stability. The phase margin is usually higher than 45°.

Table 2. L–C Filter Example

Inductance (L)	Output Capacitor (C _{out})
1.0 μH	22 μF
2.2 μH	10 μF
4.7 μH	4.7 μF

Inductor Selection

The inductor parameters directly related to device performances are saturation current and DC resistance and inductance value. The inductor ripple current (ΔI_L) decreases with higher inductance:

$$\Delta I_L = \frac{V_{OUT}}{L \times f_{SW}} \left(1 - \frac{V_{OUT}}{V_{IN}}\right) \quad (\text{eq. 4})$$

ΔI_L peak to peak inductor ripple current

L inductor value

f_{sw} switching frequency

The saturation current of the inductor should be rated higher than the maximum load current plus half the ripple current:

$$I_{L(MAX)} = I_{O(MAX)} + \frac{\Delta I_L}{2} \quad (\text{eq. 5})$$

ΔI_{L(MAX)} Maximum inductor current

ΔI_{O(MAX)} Maximum Output current

The inductor's resistance will factor into the overall efficiency of the converter. For best performances, the DC resistance should be less than 0.3 Ω for good efficiency.

Table 3. LIST OF INDUCTOR

FDK	MIPW3226 Series
TDK	VLF3010AT Series
Taiyo Yuden	LQ CBL2012
Coil craft	DO1605-T Series
	LPO3010

Output Capacitor Selection

Selecting the proper output capacitor is based on the desired output ripple voltage. Ceramic capacitors with low ESR values will have the lowest output ripple voltage and are strongly recommended. The output capacitor requires either an X7R or X5R dielectric.

The output ripple voltage in PWM mode is given by:

$$\Delta V_{OUT} = \Delta I_L \times \left(\frac{1}{4 \times f_{SW} \times C_{OUT}} + ESR \right) \quad (\text{eq. 6})$$

In PFM mode (at light load), the output voltage is regulated by pulse frequency modulation. The output voltage ripple is independent of the output capacitor value. It is set by the threshold of PFM comparator.

Table 4. LIST OF OUTPUT CAPACITOR

Murata	GRM188R60J475KE	4.7 μ F
	GRM21BR60J106ME19L	10 μ F
	GRM188R60OJ106ME	10 μ F
Taiyo Yuden	JMK212BY475MG	4.7 μ F
	JMK212BJ106MG	10 μ F
TDK	C2012X5ROJ475KB	4.7 μ F
	C2012X5ROJ226M	22 μ F
	C2012X5ROJ106K	10 μ F

Feed-Forward Capacitor Selection

The feed-forward capacitor sets the feedback loop response and is critical to obtain good loop stability.

Given that the compensation is internally fixed, a fixed 18 pF or higher ceramic capacitor is needed. Choose a small ceramic capacitor X7R or X5R or COG dielectric.

DISCONTINUED

THIS DEVICE IS NOT RECOMMENDED FOR NEW DESIGN
PLEASE CONTACT YOUR onsemi
REPRESENTATIVE FOR INFORMATION

MECHANICAL CASE OUTLINE PACKAGE DIMENSIONS

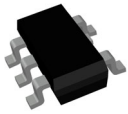

TSOP-5 3.00x1.50x0.95, 0.95P CASE 483 ISSUE P

DATE 01 APR 2024

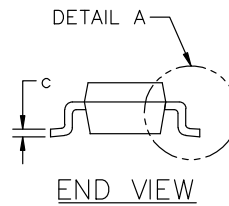
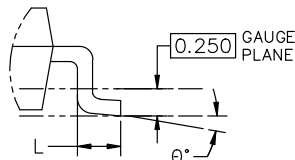

NOTES:

1. DIMENSIONING AND TOLERANCING CONFORM TO ASME Y14.5-2018.
2. ALL DIMENSION ARE IN MILLIMETERS (ANGLES IN DEGREES).
3. MAXIMUM LEAD THICKNESS INCLUDES LEAD FINISH THICKNESS. MINIMUM LEAD THICKNESS IS THE MINIMUM THICKNESS OF BASE MATERIAL.
4. DIMENSIONS D AND E1 DO NOT INCLUDE MOLD FLASH, PROTRUSIONS OF GATE BURRS. MOLD FLASH, PROTRUSIONS, OR GATE BURRS SHALL NOT EXCEED 0.15 PER SIDE. DIMENSION D.
5. OPTIONAL CONSTRUCTION: AN ADDITIONAL TRIMMED LEAD IS ALLOWED IN THIS LOCATION. TRIMMED LEAD NOT TO EXTEND MORE THAN 0.2 FROM BODY.

DIM	MILLIMETERS		
	MIN.	NOM.	MAX.
A	0.900	1.000	1.100
A1	0.010	0.055	0.100
A2	0.950 REF.		
b	0.250	0.375	0.500
c	0.100	0.180	0.260
D	2.850	3.000	3.150
E	2.500	2.750	3.000
E1	1.350	1.500	1.650
e	0.950 BSC		
L	0.200	0.400	0.600
θ	0°	5°	10°

GENERIC MARKING DIAGRAM*

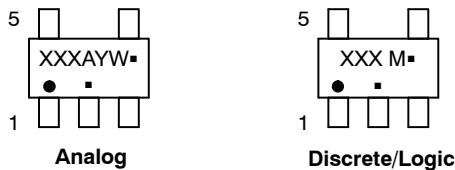

- XXX = Specific Device Code XXX = Specific Device Code
 A = Assembly Location M = Date Code
 Y = Year ▪ = Pb-Free Package
 W = Work Week

▪ = Pb-Free Package

(Note: Microdot may be in either location)

*This information is generic. Please refer to device data sheet for actual part marking. Pb-Free indicator, "G" or microdot "▪", may or may not be present. Some products may not follow the Generic Marking.

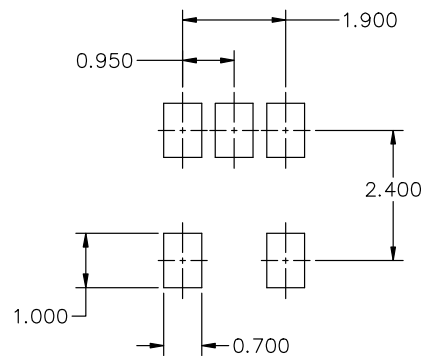

* FOR ADDITIONAL INFORMATION ON OUR Pb-FREE STRATEGY AND SOLDERING DETAILS, PLEASE DOWNLOAD THE ON SEMICONDUCTOR SOLDERING AND MOUNTING TECHNIQUES REFERENCE MANUAL, SOLDERM/D.

DOCUMENT NUMBER:	98ARB18753C	Electronic versions are uncontrolled except when accessed directly from the Document Repository. Printed versions are uncontrolled except when stamped "CONTROLLED COPY" in red.
DESCRIPTION:	TSOP-5 3.00x1.50x0.95, 0.95P	PAGE 1 OF 1

onsemi and ONSEMI are trademarks of Semiconductor Components Industries, LLC dba onsemi or its subsidiaries in the United States and/or other countries. onsemi reserves the right to make changes without further notice to any products herein. onsemi makes no warranty, representation or guarantee regarding the suitability of its products for any particular purpose, nor does onsemi assume any liability arising out of the application or use of any product or circuit, and specifically disclaims any and all liability, including without limitation special, consequential or incidental damages. onsemi does not convey any license under its patent rights nor the rights of others.

onsemi, **Onsemi**, and other names, marks, and brands are registered and/or common law trademarks of Semiconductor Components Industries, LLC dba "**onsemi**" or its affiliates and/or subsidiaries in the United States and/or other countries. **onsemi** owns the rights to a number of patents, trademarks, copyrights, trade secrets, and other intellectual property. A listing of **onsemi**'s product/patent coverage may be accessed at www.onsemi.com/site/pdf/Patent-Marking.pdf. **onsemi** reserves the right to make changes at any time to any products or information herein, without notice. The information herein is provided "as-is" and **onsemi** makes no warranty, representation or guarantee regarding the accuracy of the information, product features, availability, functionality, or suitability of its products for any particular purpose, nor does **onsemi** assume any liability arising out of the application or use of any product or circuit, and specifically disclaims any and all liability, including without limitation special, consequential or incidental damages. Buyer is responsible for its products and applications using **onsemi** products, including compliance with all laws, regulations and safety requirements or standards, regardless of any support or applications information provided by **onsemi**. "Typical" parameters which may be provided in **onsemi** data sheets and/or specifications can and do vary in different applications and actual performance may vary over time. All operating parameters, including "Typicals" must be validated for each customer application by customer's technical experts. **onsemi** does not convey any license under any of its intellectual property rights nor the rights of others. **onsemi** products are not designed, intended, or authorized for use as a critical component in life support systems or any FDA Class 3 medical devices or medical devices with a same or similar classification in a foreign jurisdiction or any devices intended for implantation in the human body. Should Buyer purchase or use **onsemi** products for any such unintended or unauthorized application, Buyer shall indemnify and hold **onsemi** and its officers, employees, subsidiaries, affiliates, and distributors harmless against all claims, costs, damages, and expenses, and reasonable attorney fees arising out of, directly or indirectly, any claim of personal injury or death associated with such unintended or unauthorized use, even if such claim alleges that **onsemi** was negligent regarding the design or manufacture of the part. **onsemi** is an Equal Opportunity/Affirmative Action Employer. This literature is subject to all applicable copyright laws and is not for resale in any manner.

ADDITIONAL INFORMATION

TECHNICAL PUBLICATIONS:

Technical Library: www.onsemi.com/design/resources/technical-documentation
onsemi Website: www.onsemi.com

ONLINE SUPPORT: www.onsemi.com/support

For additional information, please contact your local Sales Representative at www.onsemi.com/support/sales