

MJD47, NJVMJD47T4G, MJD50, NJVMJD50T4G

High Voltage Power Transistors

DPAK for Surface Mount Applications

Designed for line operated audio output amplifier, switchmode supply drivers and other switching applications.

Features

- Lead Formed for Surface Mount Applications in Plastic Sleeves (No Suffix)
- Electrically Similar to Popular TIP47, and TIP50
- Epoxy Meets UL 94 V-0 @ 0.125 in
- NJV Prefix for Automotive and Other Applications Requiring Unique Site and Control Change Requirements; AEC-Q101 Qualified and PPAP Capable
- These Devices are Pb-Free and are RoHS Compliant

MAXIMUM RATINGS

Rating	Symbol	Max	Unit
Collector-Emitter Voltage MJD47, NJVMJD47T4G MJD50, NJVMJD50T4G	V_{CEO}	250 400	Vdc
Collector-Base Voltage MJD47, NJVMJD47T4G MJD50, NJVMJD50T4G	V_{CB}	350 500	Vdc
Emitter-Base Voltage	V_{EB}	5	Vdc
Collector Current – Continuous	I_C	1	Adc
Collector Current – Peak	I_{CM}	2	Adc
Base Current	I_B	0.6	Adc
Total Power Dissipation @ $T_C = 25^\circ\text{C}$ Derate above 25°C	P_D	15 0.12	W W/ $^\circ\text{C}$
Total Power Dissipation (Note 1) @ $T_A = 25^\circ\text{C}$ Derate above 25°C	P_D	1.56 0.0125	W W/ $^\circ\text{C}$
Operating and Storage Junction Temperature Range	T_J, T_{stg}	-65 to +150	$^\circ\text{C}$
ESD – Human Body Model	HBM	3B	V
ESD – Machine Model	MM	C	V

Stresses exceeding those listed in the Maximum Ratings table may damage the device. If any of these limits are exceeded, device functionality should not be assumed, damage may occur and reliability may be affected.

1. These ratings are applicable when surface mounted on the minimum pad sizes recommended.



ON Semiconductor®

<http://onsemi.com>

NPN SILICON POWER TRANSISTORS 1 AMPERE 250, 400 VOLTS, 15 WATTS

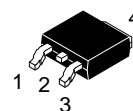
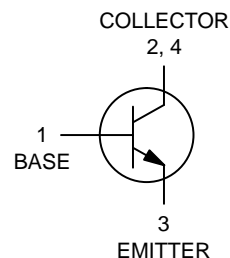

DPAK
CASE 369C
STYLE 1

MARKING DIAGRAM

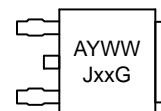

- A = Assembly Location
- Y = Year
- WW = Work Week
- Jxx = Device Code
xx = 47 or 50
- G = Pb-Free Package

ORDERING INFORMATION

See detailed ordering and shipping information in the package dimensions section on page 5 of this data sheet.

MJD47, NJVMJD47T4G, MJD50, NJVMJD50T4G

THERMAL CHARACTERISTICS

Characteristic	Symbol	Max	Unit
Thermal Resistance Junction-to-Case	$R_{\theta JC}$	8.33	$^{\circ}\text{C}/\text{W}$
Thermal Resistance Junction-to-Ambient (Note 2)	$R_{\theta JA}$	80	$^{\circ}\text{C}/\text{W}$
Lead Temperature for Soldering Purpose	T_L	260	$^{\circ}\text{C}$

2. These ratings are applicable when surface mounted on the minimum pad sizes recommended.

ELECTRICAL CHARACTERISTICS ($T_C = 25^{\circ}\text{C}$ unless otherwise noted)

Characteristic	Symbol	Min	Max	Unit
----------------	--------	-----	-----	------

OFF CHARACTERISTICS

Collector-Emitter Sustaining Voltage (Note 3) ($I_C = 30 \text{ mAdc}$, $I_B = 0$) MJD47, NJVMJD47T4G MJD50, NJVMJD50T4G	$V_{CE(sus)}$	250 400	- -	Vdc
Collector Cutoff Current ($V_{CE} = 150 \text{ Vdc}$, $I_B = 0$) MJD47, NJVMJD47T4G ($V_{CE} = 300 \text{ Vdc}$, $I_B = 0$) MJD50, NJVMJD50T4G	I_{CEO}	- -	0.2 0.2	mAdc
Collector Cutoff Current ($V_{CE} = 350 \text{ Vdc}$, $V_{BE} = 0$) MJD47, NJVMJD47T4G ($V_{CE} = 500 \text{ Vdc}$, $V_{BE} = 0$) MJD50, NJVMJD50T4G	I_{CES}	- -	0.1 0.1	mAdc
Emitter Cutoff Current ($V_{BE} = 5 \text{ Vdc}$, $I_C = 0$)	I_{EBO}	-	1	mAdc

ON CHARACTERISTICS (Note 3)

DC Current Gain ($I_C = 0.3 \text{ Adc}$, $V_{CE} = 10 \text{ Vdc}$) ($I_C = 1 \text{ Adc}$, $V_{CE} = 10 \text{ Vdc}$)	h_{FE}	30 10	150 -	-
Collector-Emitter Saturation Voltage ($I_C = 1 \text{ Adc}$, $I_B = 0.2 \text{ Adc}$)	$V_{CE(sat)}$	-	1	Vdc
Base-Emitter On Voltage ($I_C = 1 \text{ Adc}$, $V_{CE} = 10 \text{ Vdc}$)	$V_{BE(on)}$	-	1.5	Vdc

DYNAMIC CHARACTERISTICS

Current Gain – Bandwidth Product ($I_C = 0.2 \text{ Adc}$, $V_{CE} = 10 \text{ Vdc}$, $f = 2 \text{ MHz}$)	f_T	10	-	MHz
Small-Signal Current Gain ($I_C = 0.2 \text{ Adc}$, $V_{CE} = 10 \text{ Vdc}$, $f = 1 \text{ kHz}$)	h_{fe}	25	-	-

3. Pulse Test: Pulse Width $\leq 300 \mu\text{s}$, Duty Cycle $\leq 2\%$.

MJD47, NJVMJD47T4G, MJD50, NJVMJD50T4G

TYPICAL CHARACTERISTICS

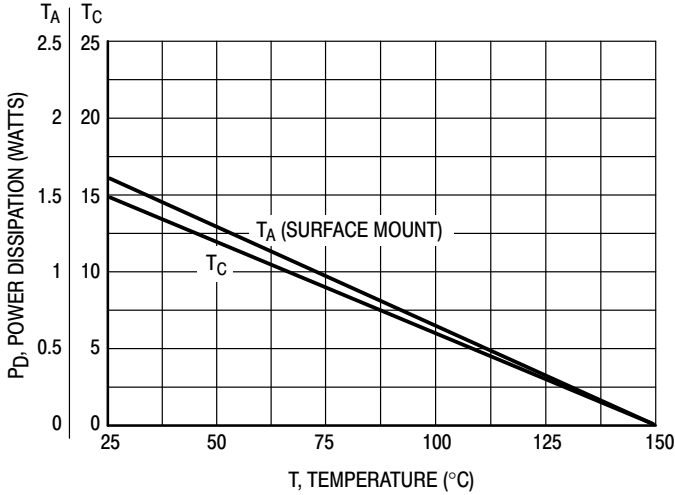

Figure 1. Power Derating

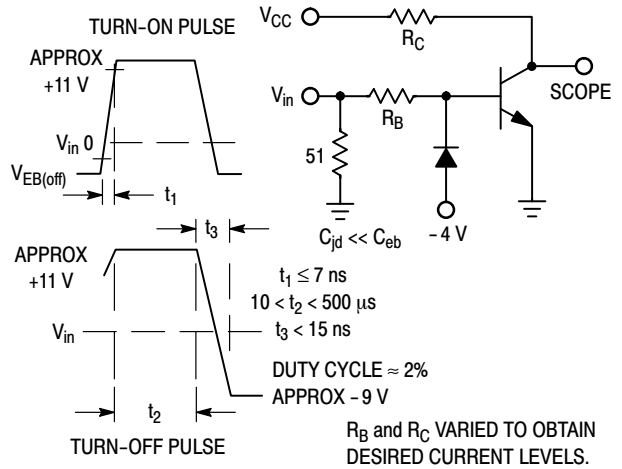

Figure 2. Switching Time Equivalent Circuit

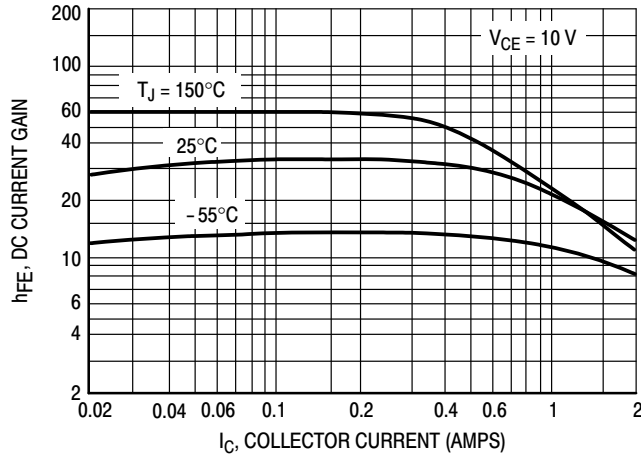

Figure 3. DC Current Gain

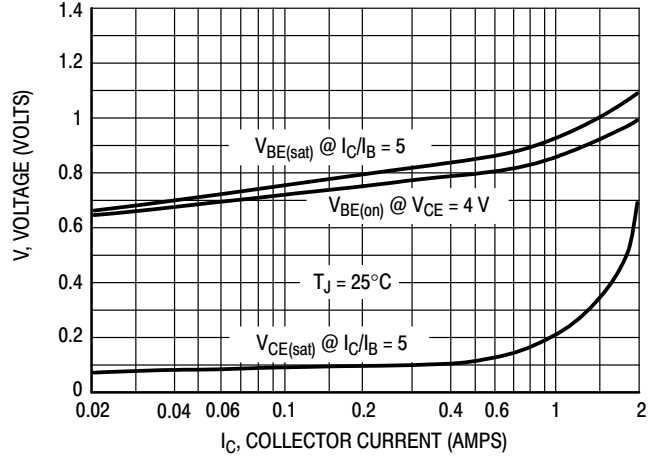

Figure 4. "On" Voltages

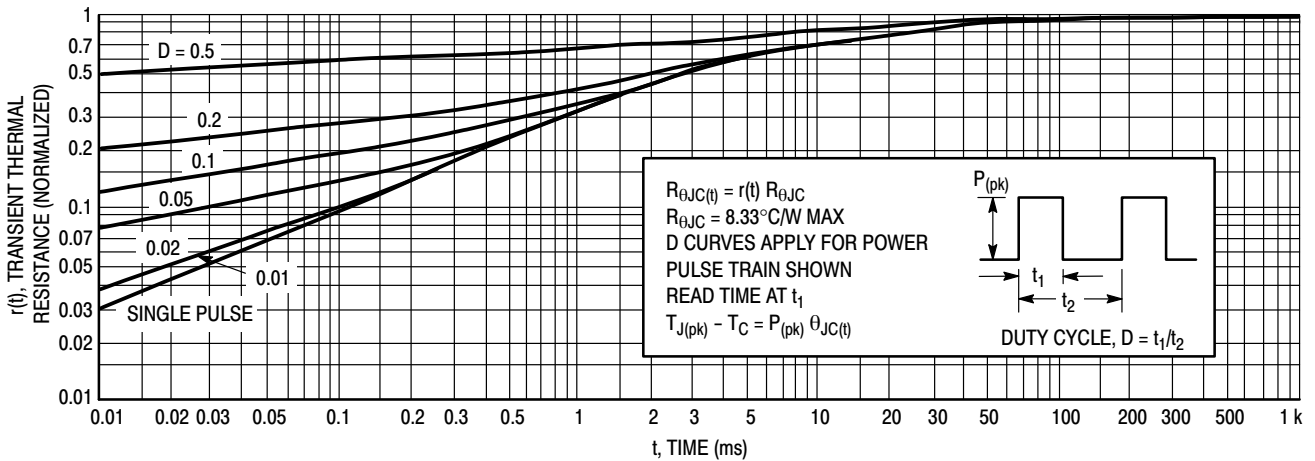

Figure 5. Thermal Response

MJD47, NJVMJD47T4G, MJD50, NJVMJD50T4G

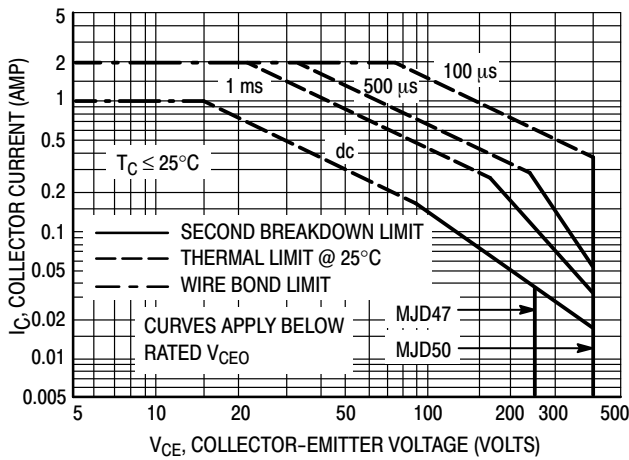

Figure 6. Active Region Safe Operating Area

There are two limitations on the power handling ability of a transistor: average junction temperature and second breakdown. Safe operating area curves indicate $I_C - V_{CE}$ limits of the transistor that must be observed for reliable operation; i.e., the transistor must not be subjected to greater dissipation than the curves indicate.

The data of Figure 6 is based on $T_{J(pk)} = 150^\circ\text{C}$; T_C is variable depending on conditions. Second breakdown pulse limits are valid for duty cycles to 10% provided $T_{J(pk)} \leq 150^\circ\text{C}$. $T_{J(pk)}$ may be calculated from the data in Figure 5. At high case temperatures, thermal limitations will reduce the power that can be handled to values less than the limitations imposed by second breakdown.

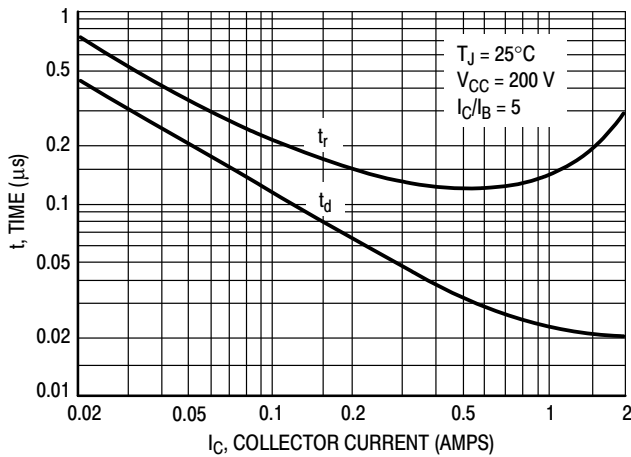

Figure 7. Turn-On Time

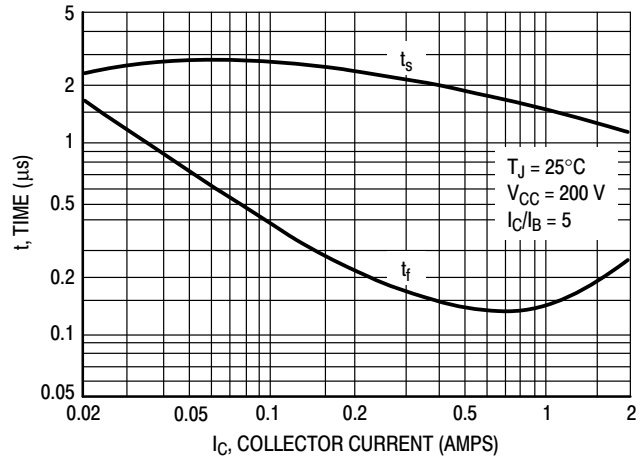

Figure 8. Turn-Off Time

MJD47, NJVMJD47T4G, MJD50, NJVMJD50T4G

ORDERING INFORMATION

Device	Package	Shipping†
MJD47G	369C (Pb-Free)	75 Units / Rail
MJD47T4G	369C (Pb-Free)	2,500 / Tape & Reel
NJVMJD47T4G*	369C (Pb-Free)	2,500 / Tape & Reel
MJD50G	369C (Pb-Free)	75 Units / Rail
MJD50T4G	369C (Pb-Free)	2,500 / Tape & Reel
NJVMJD50T4G*	369C (Pb-Free)	2,500 / Tape & Reel

†For information on tape and reel specifications, including part orientation and tape sizes, please refer to our Tape and Reel Packaging Specification Brochure, BRD8011/D.

*NJV Prefix for Automotive and Other Applications Requiring Unique Site and Control Change Requirements; AEC-Q101 Qualified and PPAP Capable.

onsemi, **Onsemi**, and other names, marks, and brands are registered and/or common law trademarks of Semiconductor Components Industries, LLC dba "**onsemi**" or its affiliates and/or subsidiaries in the United States and/or other countries. **onsemi** owns the rights to a number of patents, trademarks, copyrights, trade secrets, and other intellectual property. A listing of **onsemi**'s product/patent coverage may be accessed at www.onsemi.com/site/pdf/Patent-Marking.pdf. **onsemi** reserves the right to make changes at any time to any products or information herein, without notice. The information herein is provided "as-is" and **onsemi** makes no warranty, representation or guarantee regarding the accuracy of the information, product features, availability, functionality, or suitability of its products for any particular purpose, nor does **onsemi** assume any liability arising out of the application or use of any product or circuit, and specifically disclaims any and all liability, including without limitation special, consequential or incidental damages. Buyer is responsible for its products and applications using **onsemi** products, including compliance with all laws, regulations and safety requirements or standards, regardless of any support or applications information provided by **onsemi**. "Typical" parameters which may be provided in **onsemi** data sheets and/or specifications can and do vary in different applications and actual performance may vary over time. All operating parameters, including "Typicals" must be validated for each customer application by customer's technical experts. **onsemi** does not convey any license under any of its intellectual property rights nor the rights of others. **onsemi** products are not designed, intended, or authorized for use as a critical component in life support systems or any FDA Class 3 medical devices or medical devices with a same or similar classification in a foreign jurisdiction or any devices intended for implantation in the human body. Should Buyer purchase or use **onsemi** products for any such unintended or unauthorized application, Buyer shall indemnify and hold **onsemi** and its officers, employees, subsidiaries, affiliates, and distributors harmless against all claims, costs, damages, and expenses, and reasonable attorney fees arising out of, directly or indirectly, any claim of personal injury or death associated with such unintended or unauthorized use, even if such claim alleges that **onsemi** was negligent regarding the design or manufacture of the part. **onsemi** is an Equal Opportunity/Affirmative Action Employer. This literature is subject to all applicable copyright laws and is not for resale in any manner.

ADDITIONAL INFORMATION

TECHNICAL PUBLICATIONS:

Technical Library: www.onsemi.com/design/resources/technical-documentation
onsemi Website: www.onsemi.com

ONLINE SUPPORT: www.onsemi.com/support

For additional information, please contact your local Sales Representative at www.onsemi.com/support/sales