

MC74LCX06

Low-Voltage CMOS Hex Inverter with Open Drain Outputs

With 5 V – Tolerant Inputs

The MC74LCX06 is a high performance hex inverter operating from a 2.3 V to 3.6 V supply. High impedance TTL compatible inputs significantly reduce current loading to input drivers. These LCX devices have open drain outputs which provide the ability to set output levels, or do active-HIGH AND or active-LOW OR functions. A V_I specification of 5.5 V allows MC74LCX06 inputs to be safely driven from 5.0 V devices.

Features

- Designed for 2.3 V to 3.6 V V_{CC} Operation
- 5.0 V Tolerant Inputs/Outputs
- LVTTTL Compatible
- LVCMOS Compatible
- 24 mA Output Sink Capability
- Near Zero Static Supply Current (10 μ A) Substantially Reduces System Power Requirements
- Latchup Performance Exceeds 500 mA
- Wired-OR, Wired-AND
- Output Level Can Be Set Externally Without Affecting Speed of Device
- Functionally Compatible with LCX05
- ESD Performance: Human Body Model >1500 V;
Machine Model >200 V
- These Devices are Pb-Free, Halogen Free/BFR Free and are RoHS Compliant

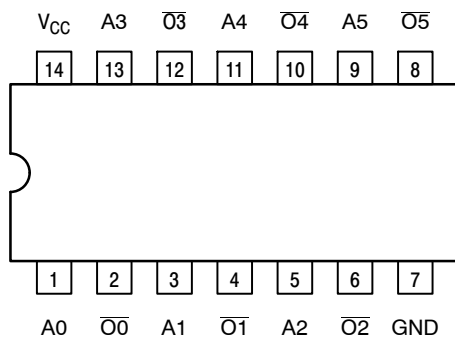

Figure 1. Pinout: 14-Lead (Top View)



ON Semiconductor®

<http://onsemi.com>

MARKING DIAGRAMS

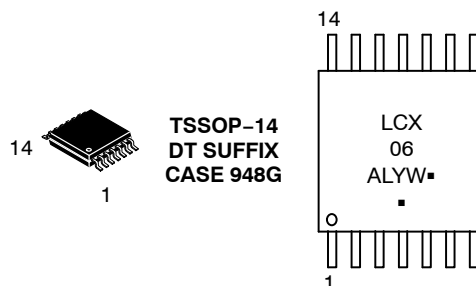
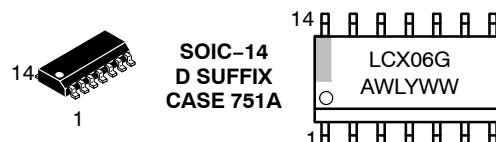

A = Assembly Location
 WL, L = Wafer Lot
 Y = Year
 WW, W = Work Week
 G or ■ = Pb-Free Package
 (Note: Microdot may be in either location)

ORDERING INFORMATION

See detailed ordering and shipping information in the package dimensions section on page 2 of this data sheet.

MC74LCX06

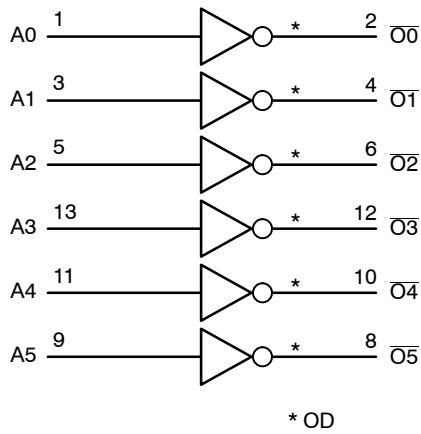

Figure 2. Logic Diagram

Table 1. PIN NAMES

| Pins | Function |
|---------------------------|------------------------|
| A_n \overline{O}_n | Data Inputs Outputs |

Table 2. TRUTH TABLE

| A_n | \overline{O}_n |
|-------|------------------|
| L | Z |
| H | L |

MAXIMUM RATINGS

| Symbol | Parameter | Value | Condition | Unit |
|-----------|----------------------------------|---------------------------|--------------------------------------|------|
| V_{CC} | DC Supply Voltage | -0.5 to +7.0 | | V |
| V_I | DC Input Voltage | $-0.5 \leq V_I \leq +7.0$ | | V |
| V_O | DC Output Voltage | $-0.5 \leq V_O \leq +7.0$ | Output in HIGH or LOW State (Note 1) | V |
| I_{IK} | DC Input Diode Current | -50 | $V_I < \text{GND}$ | mA |
| I_{OK} | DC Output Diode Current | -50 | $V_O < \text{GND}$ | mA |
| | | +50 | $V_O > V_{CC}$ | mA |
| I_O | DC Output/Sink Current | +50 | | mA |
| I_{CC} | DC Supply Current Per Supply Pin | ± 100 | | mA |
| I_{GND} | DC Ground Current Per Ground Pin | ± 100 | | mA |
| T_{STG} | Storage Temperature Range | -65 to +150 | | °C |
| MSL | Moisture Sensitivity | | Level 1 | |

Maximum ratings are those values beyond which device damage can occur. Maximum ratings applied to the device are individual stress limit values (not normal operating conditions) and are not valid simultaneously. If these limits are exceeded, device functional operation is not implied, damage may occur and reliability may be affected.

1. I_O absolute maximum rating must be observed.

ORDERING INFORMATION

| Device | Package | Shipping [†] |
|----------------|-----------------------|-----------------------|
| MC74LCX06DG | SOIC-14 (Pb-Free) | 55 Units / Rail |
| MC74LCX06DR2G | SOIC-14 (Pb-Free) | 2500 / Tape & Reel |
| MC74LCX06DTG | TSSOP-14 (Pb-Free) | 96 Units / Rail |
| MC74LCX06DTR2G | TSSOP-14 (Pb-Free) | 2500 / Tape & Reel |

[†]For information on tape and reel specifications, including part orientation and tape sizes, please refer to our Tape and Reel Packaging Specifications Brochure, BRD8011/D.

MC74LCX06

RECOMMENDED OPERATING CONDITIONS

| Symbol | Parameter | Min | Typ | Max | Unit | |
|-----------------|--|---------------------|-----|------------------|------|---|
| V _{CC} | Supply Voltage | Operating | 2.0 | 2.5, 3.3 | 3.6 | V |
| | | Data Retention Only | 1.5 | 2.5, 3.3 | 3.6 | |
| V _I | Input Voltage | 0 | | 5.5 | V | |
| V _O | Output Voltage (HIGH or LOW State) | 0 | | V _{CC} | V | |
| I _{OL} | LOW Level Output Current Sink | | | +24 +12 +8 | mA | |
| T _A | Operating Free-Air Temperature | -40 | | +85 | °C | |
| Δt/ΔV | Input Transition Rise or Fall Rate, V _{IN} from 0.8 V to 2.0 V, V _{CC} = 3.0 V | 0 | | 10 | ns/V | |

DC ELECTRICAL CHARACTERISTICS (T_A = -40°C to +85°C)

| Symbol | Characteristic | Condition | Min | Max | Unit |
|------------------|---------------------------------------|---|-----|------|------|
| V _{IH} | HIGH Level Input Voltage (Note 2) | 2.3 V ≤ V _{CC} ≤ 2.7 V | 1.7 | | V |
| | | 2.7 V ≤ V _{CC} ≤ 3.6 V | 2.0 | | |
| V _{IL} | LOW Level Input Voltage (Note 2) | 2.3 V ≤ V _{CC} ≤ 2.7 V | | 0.7 | V |
| | | 2.7 V ≤ V _{CC} ≤ 3.6 V | | 0.8 | |
| V _{OL} | LOW Level Output Voltage | 2.3 V ≤ V _{CC} ≤ 3.6 V; I _{OL} = 100 μA | | 0.2 | V |
| | | V _{CC} = 2.3 V; I _{OL} = 8 mA | | 0.3 | |
| | | V _{CC} = 2.7 V; I _{OL} = 12 mA | | 0.4 | |
| | | V _{CC} = 3.0 V; I _{OL} = 16 mA | | 0.4 | |
| | | V _{CC} = 3.0 V; I _{OL} = 24 mA | | 0.55 | |
| I _{OZ} | 3-State Output Current | V _{CC} = 3.6 V, V _{IN} = V _{IH} or V _{IL} , V _{OUT} = 0 to 5.5 V | | ±5 | μA |
| I _{OFF} | Power Off Leakage Current | V _{CC} = 0, V _{IN} = 5.5 V or V _{OUT} = 5.5 V | | 10 | μA |
| I _{IN} | Input Leakage Current | V _{CC} = 3.6 V, V _{IN} = 5.5 V or GND | | ±5 | μA |
| I _{CC} | Quiescent Supply Current | V _{CC} = 3.6 V, V _{IN} = 5.5 V or GND | | 10 | μA |
| ΔI _{CC} | Increase in I _{CC} per Input | 2.3 V ≤ V _{CC} ≤ 3.6 V One Input at V _{IH} = V _{CC} - 0.6 V | | 500 | μA |

2. These values of V_I are used to test DC electrical characteristics only.

AC ELECTRICAL CHARACTERISTICS (T_A = -40°C to +85°C)

| Symbol | Parameter | V _{CC} = 3.3 V ± 0.3 V C _L = 50 pF | | V _{CC} = 2.7 V C _L = 50 pF | | V _{CC} = 2.5 V ± 0.2 V C _L = 30 pF | | Unit |
|------------------|-------------------|---|-----|---|-----|---|-----|------|
| | | Min | Max | Min | Max | Min | Max | |
| t _{PLZ} | Propagation Delay | 0.8 | 3.7 | 1.0 | 4.1 | 0.8 | 3.5 | ns |
| t _{PZL} | Input to Output | 0.8 | 3.7 | 1.0 | 4.1 | 0.8 | 3.5 | ns |

DYNAMIC SWITCHING CHARACTERISTICS (T_A = +25°C)

| Symbol | Characteristic | Condition | Min | Typ | Max | Unit |
|------------------|-------------------------------------|--|-----|--------------|-----|------|
| V _{OLP} | Dynamic LOW Peak Voltage (Note 3) | V _{CC} = 3.3 V, C _L = 50 pF, V _{IH} = 3.3 V, V _{IL} = 0 V V _{CC} = 2.5 V, C _L = 30 pF, V _{IH} = 2.5 V, V _{IL} = 0 V | | 0.9 0.7 | | V |
| V _{OLV} | Dynamic LOW Valley Voltage (Note 3) | V _{CC} = 3.3 V, C _L = 50 pF, V _{IH} = 3.3 V, V _{IL} = 0 V V _{CC} = 2.5 V, C _L = 30 pF, V _{IH} = 2.5 V, V _{IL} = 0 V | | -0.8 -0.6 | | V |

3. Number of outputs defined as "n". Measured with "n-1" outputs switching from HIGH-to-LOW or LOW-to-HIGH. The remaining output is measured in the LOW state.

MC74LCX06

CAPACITIVE CHARACTERISTICS

| Symbol | Parameter | Condition | Typical | Unit |
|-----------|-------------------------------|--|---------|------|
| C_{IN} | Input Capacitance | $V_{CC} = 3.3\text{ V}$, $V_I = 0\text{ V}$ or V_{CC} | 7 | pF |
| C_{OUT} | Output Capacitance | $V_{CC} = 3.3\text{ V}$, $V_I = 0\text{ V}$ or V_{CC} | 8 | pF |
| C_{PD} | Power Dissipation Capacitance | 10 MHz, $V_{CC} = 3.3\text{ V}$, $V_I = 0\text{ V}$ or V_{CC} | 25 | pF |

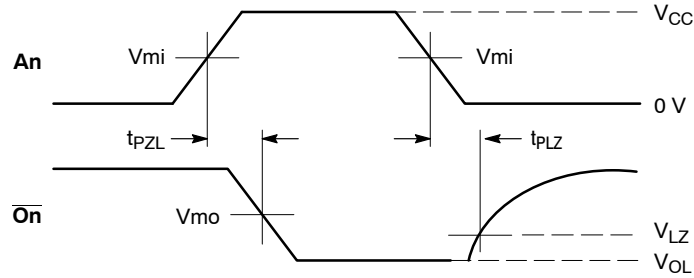

PROPAGATION DELAYS

$$t_R = t_F = 2.5\text{ ns}, 10\% \text{ to } 90\%; f = 1\text{ MHz}; t_W = 500\text{ ns}$$

Table 3. AC WAVEFORMS

| Symbol | V_{CC} | | |
|----------|---------------------------------|-------------------------|---------------------------------|
| | $3.3\text{ V} \pm 0.3\text{ V}$ | 2.7 V | $2.5\text{ V} \pm 0.2\text{ V}$ |
| V_{mi} | 1.5 V | 1.5 V | $V_{CC} / 2$ |
| V_{mo} | 1.5 V | 1.5 V | $V_{CC} / 2$ |
| V_{LZ} | $V_{OL} + 0.3\text{ V}$ | $V_{OL} + 0.3\text{ V}$ | $V_{OL} + 0.15\text{ V}$ |

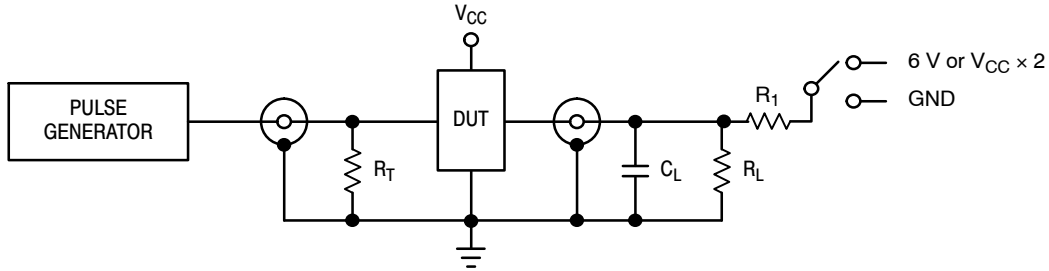

Table 4. TEST CIRCUIT

| TEST | SWITCH |
|--|--------|
| t_{PZL} , t_{PLZ} | 6 V |
| Open Collector/Drain t_{PLH} and t_{PHL} | 6 V |
| t_{PZH} , t_{PHZ} | GND |

$C_L = 50\text{ pF}$ at $V_{CC} = 3.3 \pm 0.3\text{ V}$ or equivalent (includes jig and probe capacitance)

$C_L = 30\text{ pF}$ at $V_{CC} = 2.5 \pm 0.2\text{ V}$ or equivalent (includes jig and probe capacitance)

$R_L = R_1 = 500\ \Omega$ or equivalent

$R_T = Z_{OUT}$ of pulse generator (typically $50\ \Omega$)

MECHANICAL CASE OUTLINE PACKAGE DIMENSIONS



SCALE 1:1

SOIC-14 NB
CASE 751A-03
ISSUE L

DATE 03 FEB 2016



NOTES:

1. DIMENSIONING AND TOLERANCING PER ASME Y14.5M, 1994.
2. CONTROLLING DIMENSION: MILLIMETERS.
3. DIMENSION b DOES NOT INCLUDE DAMBAR PROTRUSION. ALLOWABLE PROTRUSION SHALL BE 0.13 TOTAL IN EXCESS OF AT MAXIMUM MATERIAL CONDITION.
4. DIMENSIONS D AND E DO NOT INCLUDE MOLD PROTRUSIONS.
5. MAXIMUM MOLD PROTRUSION 0.15 PER SIDE.

| DIM | MILLIMETERS | | INCHES | |
|-----|-------------|------|-----------|-------|
| | MIN | MAX | MIN | MAX |
| A | 1.35 | 1.75 | 0.054 | 0.068 |
| A1 | 0.10 | 0.25 | 0.004 | 0.010 |
| A3 | 0.19 | 0.25 | 0.008 | 0.010 |
| b | 0.35 | 0.49 | 0.014 | 0.019 |
| D | 8.55 | 8.75 | 0.337 | 0.344 |
| E | 3.80 | 4.00 | 0.150 | 0.157 |
| e | 1.27 BSC | | 0.050 BSC | |
| H | 5.80 | 6.20 | 0.228 | 0.244 |
| h | 0.25 | 0.50 | 0.010 | 0.019 |
| L | 0.40 | 1.25 | 0.016 | 0.049 |
| M | 0° | 7° | 0° | 7° |

SOLDERING FOOTPRINT*

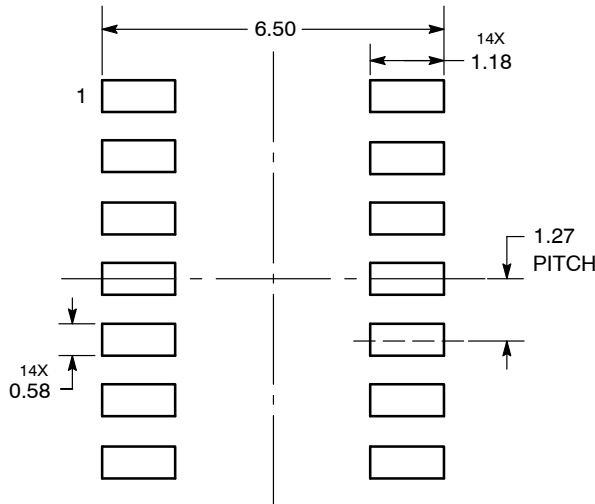

DIMENSIONS: MILLIMETERS

*For additional information on our Pb-Free strategy and soldering details, please download the ON Semiconductor Soldering and Mounting Techniques Reference Manual, SOLDERRM/D.

GENERIC MARKING DIAGRAM*



- XXXXXX = Specific Device Code
- A = Assembly Location
- WL = Wafer Lot
- Y = Year
- WW = Work Week
- G = Pb-Free Package

*This information is generic. Please refer to device data sheet for actual part marking. Pb-Free indicator, "G" or microdot "▪", may or may not be present. Some products may not follow the Generic Marking.

STYLES ON PAGE 2

| | | |
|------------------|-------------|--|
| DOCUMENT NUMBER: | 98ASB42565B | Electronic versions are uncontrolled except when accessed directly from the Document Repository. Printed versions are uncontrolled except when stamped "CONTROLLED COPY" in red. |
| DESCRIPTION: | SOIC-14 NB | PAGE 1 OF 2 |

onsemi and ONSEMI are trademarks of Semiconductor Components Industries, LLC dba onsemi or its subsidiaries in the United States and/or other countries. onsemi reserves the right to make changes without further notice to any products herein. onsemi makes no warranty, representation or guarantee regarding the suitability of its products for any particular purpose, nor does onsemi assume any liability arising out of the application or use of any product or circuit, and specifically disclaims any and all liability, including without limitation special, consequential or incidental damages. onsemi does not convey any license under its patent rights nor the rights of others.

SOIC-14
CASE 751A-03
ISSUE L

DATE 03 FEB 2016

STYLE 1:
 PIN 1. COMMON CATHODE
 2. ANODE/CATHODE
 3. ANODE/CATHODE
 4. NO CONNECTION
 5. ANODE/CATHODE
 6. NO CONNECTION
 7. ANODE/CATHODE
 8. ANODE/CATHODE
 9. ANODE/CATHODE
 10. NO CONNECTION
 11. ANODE/CATHODE
 12. ANODE/CATHODE
 13. NO CONNECTION
 14. COMMON ANODE

STYLE 2:
 CANCELLED

STYLE 3:
 PIN 1. NO CONNECTION
 2. ANODE
 3. ANODE
 4. NO CONNECTION
 5. ANODE
 6. NO CONNECTION
 7. ANODE
 8. ANODE
 9. ANODE
 10. NO CONNECTION
 11. ANODE
 12. ANODE
 13. NO CONNECTION
 14. COMMON CATHODE

STYLE 4:
 PIN 1. NO CONNECTION
 2. CATHODE
 3. CATHODE
 4. NO CONNECTION
 5. CATHODE
 6. NO CONNECTION
 7. CATHODE
 8. CATHODE
 9. CATHODE
 10. NO CONNECTION
 11. CATHODE
 12. CATHODE
 13. NO CONNECTION
 14. COMMON ANODE

STYLE 5:
 PIN 1. COMMON CATHODE
 2. ANODE/CATHODE
 3. ANODE/CATHODE
 4. ANODE/CATHODE
 5. ANODE/CATHODE
 6. NO CONNECTION
 7. COMMON ANODE
 8. COMMON CATHODE
 9. ANODE/CATHODE
 10. ANODE/CATHODE
 11. ANODE/CATHODE
 12. ANODE/CATHODE
 13. NO CONNECTION
 14. COMMON ANODE

STYLE 6:
 PIN 1. CATHODE
 2. CATHODE
 3. CATHODE
 4. CATHODE
 5. CATHODE
 6. CATHODE
 7. CATHODE
 8. ANODE
 9. ANODE
 10. ANODE
 11. ANODE
 12. ANODE
 13. ANODE
 14. ANODE

STYLE 7:
 PIN 1. ANODE/CATHODE
 2. COMMON ANODE
 3. COMMON CATHODE
 4. ANODE/CATHODE
 5. ANODE/CATHODE
 6. ANODE/CATHODE
 7. ANODE/CATHODE
 8. ANODE/CATHODE
 9. ANODE/CATHODE
 10. ANODE/CATHODE
 11. COMMON CATHODE
 12. COMMON ANODE
 13. ANODE/CATHODE
 14. ANODE/CATHODE

STYLE 8:
 PIN 1. COMMON CATHODE
 2. ANODE/CATHODE
 3. ANODE/CATHODE
 4. NO CONNECTION
 5. ANODE/CATHODE
 6. ANODE/CATHODE
 7. COMMON ANODE
 8. COMMON ANODE
 9. ANODE/CATHODE
 10. ANODE/CATHODE
 11. NO CONNECTION
 12. ANODE/CATHODE
 13. ANODE/CATHODE
 14. COMMON CATHODE

| | | |
|-------------------------|--------------------|---|
| DOCUMENT NUMBER: | 98ASB42565B | Electronic versions are uncontrolled except when accessed directly from the Document Repository. Printed versions are uncontrolled except when stamped "CONTROLLED COPY" in red. |
| DESCRIPTION: | SOIC-14 NB | PAGE 2 OF 2 |

onsemi and **ONSEMI** are trademarks of Semiconductor Components Industries, LLC dba **onsemi** or its subsidiaries in the United States and/or other countries. **onsemi** reserves the right to make changes without further notice to any products herein. **onsemi** makes no warranty, representation or guarantee regarding the suitability of its products for any particular purpose, nor does **onsemi** assume any liability arising out of the application or use of any product or circuit, and specifically disclaims any and all liability, including without limitation special, consequential or incidental damages. **onsemi** does not convey any license under its patent rights nor the rights of others.

onsemi, **Onsemi**, and other names, marks, and brands are registered and/or common law trademarks of Semiconductor Components Industries, LLC dba "**onsemi**" or its affiliates and/or subsidiaries in the United States and/or other countries. **onsemi** owns the rights to a number of patents, trademarks, copyrights, trade secrets, and other intellectual property. A listing of **onsemi**'s product/patent coverage may be accessed at www.onsemi.com/site/pdf/Patent-Marking.pdf. **onsemi** reserves the right to make changes at any time to any products or information herein, without notice. The information herein is provided "as-is" and **onsemi** makes no warranty, representation or guarantee regarding the accuracy of the information, product features, availability, functionality, or suitability of its products for any particular purpose, nor does **onsemi** assume any liability arising out of the application or use of any product or circuit, and specifically disclaims any and all liability, including without limitation special, consequential or incidental damages. Buyer is responsible for its products and applications using **onsemi** products, including compliance with all laws, regulations and safety requirements or standards, regardless of any support or applications information provided by **onsemi**. "Typical" parameters which may be provided in **onsemi** data sheets and/or specifications can and do vary in different applications and actual performance may vary over time. All operating parameters, including "Typicals" must be validated for each customer application by customer's technical experts. **onsemi** does not convey any license under any of its intellectual property rights nor the rights of others. **onsemi** products are not designed, intended, or authorized for use as a critical component in life support systems or any FDA Class 3 medical devices or medical devices with a same or similar classification in a foreign jurisdiction or any devices intended for implantation in the human body. Should Buyer purchase or use **onsemi** products for any such unintended or unauthorized application, Buyer shall indemnify and hold **onsemi** and its officers, employees, subsidiaries, affiliates, and distributors harmless against all claims, costs, damages, and expenses, and reasonable attorney fees arising out of, directly or indirectly, any claim of personal injury or death associated with such unintended or unauthorized use, even if such claim alleges that **onsemi** was negligent regarding the design or manufacture of the part. **onsemi** is an Equal Opportunity/Affirmative Action Employer. This literature is subject to all applicable copyright laws and is not for resale in any manner.

ADDITIONAL INFORMATION

TECHNICAL PUBLICATIONS:

Technical Library: www.onsemi.com/design/resources/technical-documentation
onsemi Website: www.onsemi.com

ONLINE SUPPORT: www.onsemi.com/support

For additional information, please contact your local Sales Representative at www.onsemi.com/support/sales