

MOSFET – N-Channel, QFET®

1000 V, 1.6 A, 9 Ω

FQU2N100, FQD2N100

This N-Channel enhancement mode power MOSFET is produced using onsemi's proprietary planar stripe and DMOS technology. This advanced MOSFET technology has been especially tailored to reduce on-state resistance, and to provide superior switching performance and high avalanche energy strength. These devices are suitable for switched mode power supplies, active power factor correction (PFC), and electronic lamp ballasts.

Features

- 1.6 A, 1000 V, $R_{DS(on)} = 9 \Omega$ (Max.) @ $V_{GS} = 10 V$, $I_D = 0.8 A$
- Low Gate Charge (Typ. 12 nC)
- Low C_{rss} (Typ. 5 pF)
- 100% Avalanche Tested
- These Devices are Pb-Free, Halid Free and are RoHS Compliant

MAXIMUM RATINGS ($T_C = 25^\circ C$ unless otherwise noted)

| Rating | Symbol | Value | Unit |
|---|----------------|----------------|-----------|
| Drain-Source Voltage | V_{DSS} | 1000 | V |
| Drain Current – Continuous ($T_C = 25^\circ C$) – Continuous ($T_C = 100^\circ C$) | I_D | 1.6 1.0 | A |
| Drain Current – Pulsed (Note 1) | I_{DM} | 6.4 | A |
| Gate-Source Voltage | V_{GSS} | ± 30 | V |
| Single Pulsed Avalanche Energy (Note 2) | E_{AS} | 160 | mJ |
| Avalanche Current (Note 1) | I_{AR} | 1.6 | A |
| Repetitive Avalanche Energy (Note 1) | E_{AR} | 5.0 | mJ |
| Peak Diode Recovery dv/dt (Note 3) | dv/dt | 5.5 | V/ns |
| Power Dissipation ($T_A = 25^\circ C$) * | P_D | 2.5 | W |
| Power Dissipation ($T_C = 25^\circ C$) – Derate above $25^\circ C$ | | 50 0.4 | W W/°C |
| Operating and Storage Temperature Range | T_J, T_{STG} | -55 to +150 | °C |
| Maximum Lead Temperature for Soldering Purposes, 1/8" (from case for 5 seconds) | T_L | 300 | °C |

Stresses exceeding those listed in the Maximum Ratings table may damage the device. If any of these limits are exceeded, device functionality should not be assumed, damage may occur and reliability may be affected.

| V_{DSS} | $R_{DS(ON)} MAX$ | $I_D MAX$ |
|-----------|------------------|-----------|
| 1000 V | 9 Ω @ 10 V | 1.6 A |

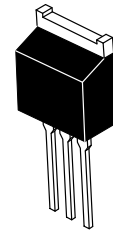
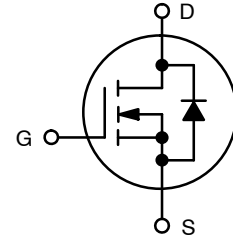

DPAK3 (IPAK)
CASE 369AR

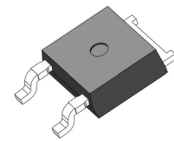

DPAK3 (TO-252 3 LD)
CASE 369AS

MARKING DIAGRAMS

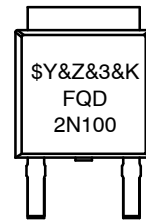
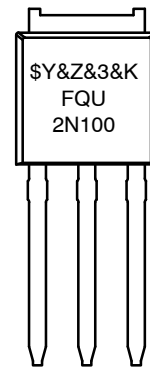

FQU2N100,
FQD2N100 = Device Code
\$Y = onsemi Logo
&Z = Assembly Location
&3 = 3-Digit Date Code
&K = 2-Digits Lot Run Traceability Code

ORDERING INFORMATION

| Device | Package | Shipping† |
|------------|---------------------------|-----------------------|
| FQU2N100TU | DPAK3 (IPAK) (Pb-Free) | 70 Units / Tube |
| FQD2N100TM | DPAK3 (Pb-Free) | 2500 / Tape & Reel |

†For information on tape and reel specifications, including part orientation and tape sizes, please refer to our Tape and Reel Packaging Specification Brochure. BRD8011/D.

FQU2N100, FQD2N100

THERMAL CHARACTERISTICS

| Symbol | Parameter | Value | Unit |
|-----------------|---|-------|------|
| $R_{\theta JC}$ | Thermal Resistance, Junction-to-Case, Max. | 2.5 | °C/W |
| $R_{\theta JA}$ | Thermal Resistance, Junction-to-Ambient (minimum pad of 2 oz copper) , Max. | 110 | °C/W |
| | Thermal Resistance, Junction-to-Ambient (* 1 in2 pad of 2 oz copper), Max. | 50 | |

ELECTRICAL CHARACTERISTICS ($T_C = 25^\circ\text{C}$ unless otherwise specified)

| Symbol | Parameter | Test Condition | Min | Typ | Max | Unit |
|--------|-----------|----------------|-----|-----|-----|------|
|--------|-----------|----------------|-----|-----|-----|------|

OFF CHARACTERISTICS

| | | | | | | |
|--------------------------------|---|--|------|-------|------|---------------|
| BV_{DSS} | Drain-to-Source Breakdown Voltage | $I_D = 250 \mu\text{A}, V_{GS} = 0 \text{ V}$ | 1000 | - | - | V |
| $\Delta BV_{DSS} / \Delta T_J$ | Breakdown Voltage Temperature Coefficient | $I_D = 250 \mu\text{A}$, Referenced to 25°C | - | 0.976 | - | V/°C |
| I_{DSS} | Zero Gate Voltage Drain Current | $V_{DS} = 1000 \text{ V}, V_{GS} = 0 \text{ V}$ | - | - | 10 | μA |
| | | $V_{DS} = 800 \text{ V}, T_C = 125^\circ\text{C}$ | - | - | 100 | |
| I_{GSSF} | Gate-Body Leakage Current, Forward | $V_{GS} = 30 \text{ V}, V_{DS} = 0 \text{ V}$ | - | - | 100 | nA |
| I_{GSSR} | Gate-Body Leakage Current, Reverse | $V_{GS} = -30 \text{ V}, V_{DS} = 0 \text{ V}$ | - | - | -100 | nA |

ON CHARACTERISTICS

| | | | | | | |
|--------------|-----------------------------------|--|-----|-----|-----|----------|
| $V_{GS(th)}$ | Gate Threshold Voltage | $V_{DS} = V_{GS}, I_D = 250 \mu\text{A}$ | 3.0 | - | 5.0 | V |
| $R_{DS(on)}$ | Static Drain-Source On Resistance | $V_{GS} = 10 \text{ V}, I_D = 0.8 \text{ A}$ | - | 7.1 | 9 | Ω |
| g_{FS} | Forward Transconductance | $V_{DS} = 50 \text{ V}, I_D = 0.8 \text{ A}$ | - | 1.9 | - | S |

DYNAMIC CHARACTERISTICS

| | | | | | | |
|-----------|------------------------------|--|---|-----|-----|----|
| C_{iss} | Input Capacitance | $V_{DS} = 25 \text{ V}, V_{GS} = 0 \text{ V}, f = 1.0 \text{ MHz}$ | - | 400 | 520 | pF |
| C_{oss} | Output Capacitance | | - | 40 | 52 | |
| C_{rss} | Reverse Transfer Capacitance | | - | 5 | 6.5 | |

SWITCHING CHARACTERISTICS

| | | | | | | |
|--------------|---------------------|---|---|-----|------|----|
| $t_{d(on)}$ | Turn-On Delay Time | $V_{DD} = 500 \text{ V}, I_D = 2.0 \text{ A}, R_G = 25 \Omega$ (Note 4) | - | 13 | 35 | ns |
| t_r | Turn-On Rise Time | | - | 30 | 70 | |
| $t_{d(off)}$ | Turn-Off Delay Time | | - | 25 | 60 | |
| t_f | Turn-Off Fall Time | | - | 35 | 80 | |
| Q_g | Total Gate Charge | $V_{DS} = 800 \text{ V}, I_D = 2.0 \text{ A}, V_{GS} = 10 \text{ V}$ (Note 4) | - | 12 | 15.5 | nC |
| Q_{gs} | Gate-Source Charge | | - | 2.5 | - | |
| Q_{gd} | Gate-Drain Charge | | - | 6.5 | - | |

DRAIN-SOURCE DIODE CHARACTERISTICS AND MAXIMUM RATINGS

| | | | | | | |
|----------|---|--|---|-----|-----|---------------|
| I_S | Maximum Continuous Drain-Source Diode Forward Current | | - | - | 1.5 | A |
| I_{SM} | Maximum Pulsed Drain-Source Diode Forward Current | | - | - | 6.0 | A |
| V_{SD} | Drain-Source Diode Forward Voltage | $V_{GS} = 0 \text{ V}, I_S = 1.6 \text{ A}$ | - | - | 1.4 | V |
| t_{rr} | Reverse Recovery Time | $V_{GS} = 0 \text{ V}, I_S = 2.0 \text{ A}, di_F/dt = 100 \text{ A}/\mu\text{s}$ | - | 520 | - | ns |
| Q_{rr} | Reverse Recovery Charge | | - | 2.3 | - | μC |

Product parametric performance is indicated in the Electrical Characteristics for the listed test conditions, unless otherwise noted. Product performance may not be indicated by the Electrical Characteristics if operated under different conditions.

1. Repetitive Rating : Pulse width limited by maximum junction temperature.
2. $L = 120 \text{ mH}, I_{AS} = 1.6 \text{ A}, V_{DD} = 50 \text{ V}, R_G = 25 \Omega$, Starting $T_J = 25^\circ\text{C}$.
3. $I_{SD} \leq 2.0 \text{ A}, di/dt \leq 300 \text{ A}/\mu\text{s}, V_{DD} \leq BV_{DSS}$, Starting $T_J = 25^\circ\text{C}$.
4. Essentially independent of operating temperature.

FQU2N100, FQD2N100

TYPICAL CHARACTERISTICS

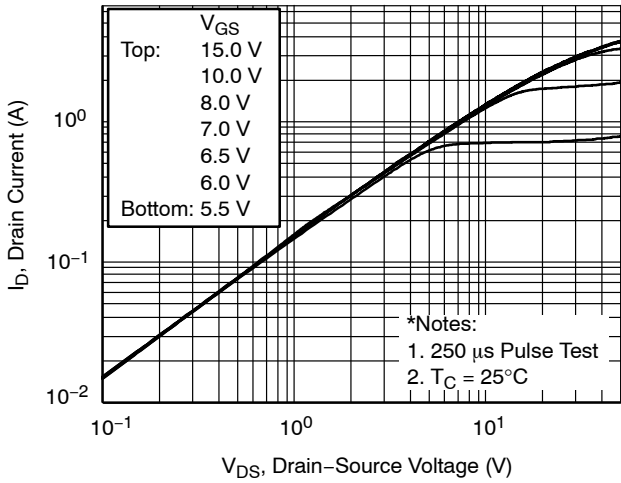

Figure 1. On-Region Characteristics

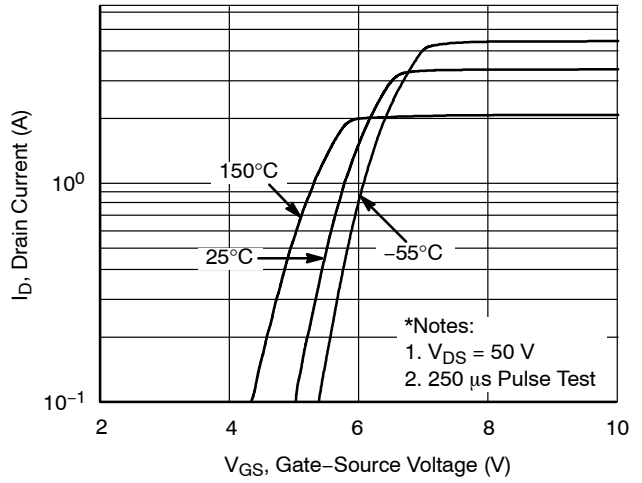

Figure 2. Transfer Characteristics

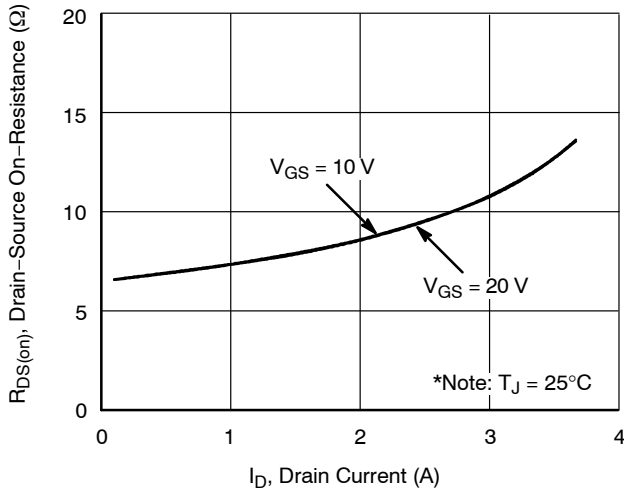

Figure 3. On-Resistance Variation vs. Drain Current and Gate Voltage

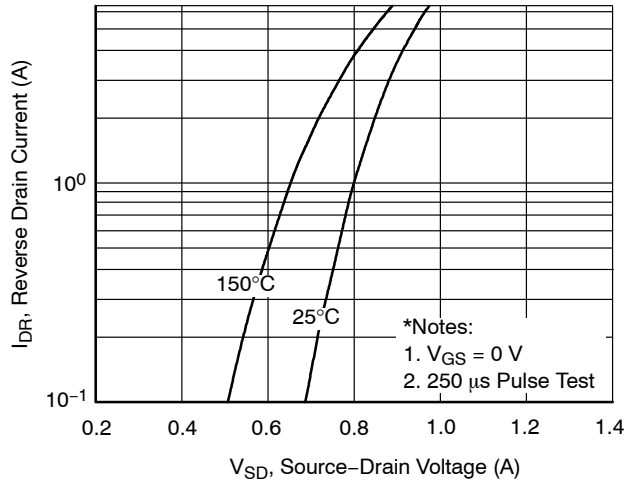

Figure 4. Body Diode Forward Voltage Variation vs. Source Current and Temperature

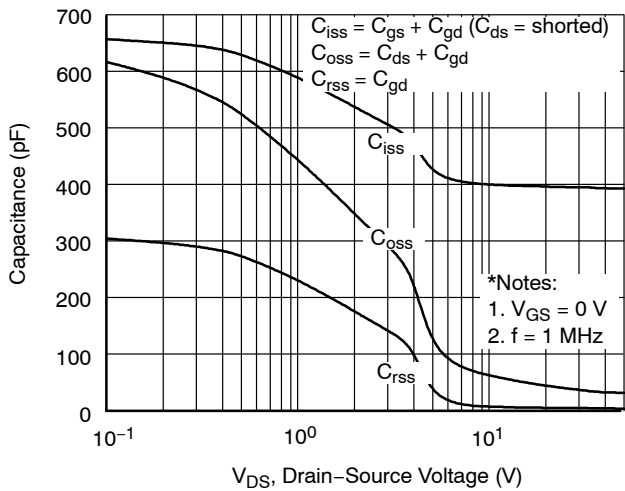

Figure 5. Capacitance Characteristics

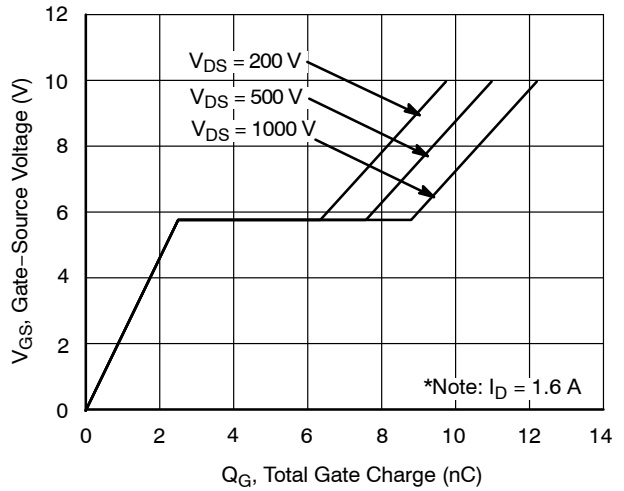

Figure 6. Gate Charge Characteristics

FQU2N100, FQD2N100

TYPICAL CHARACTERISTICS (continued)

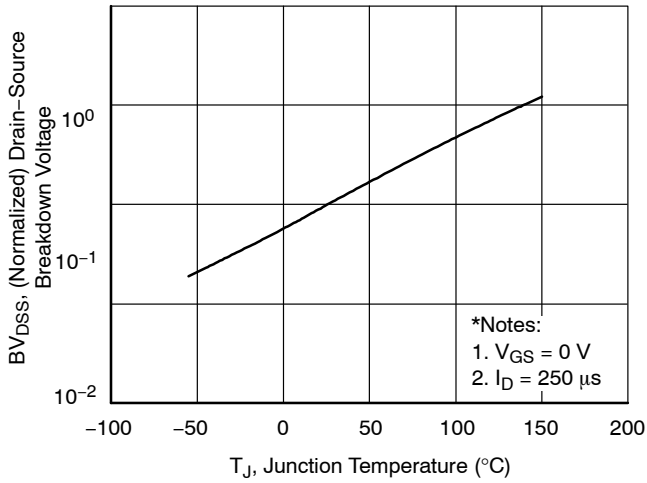

Figure 7. Breakdown Voltage Variation vs. Temperature

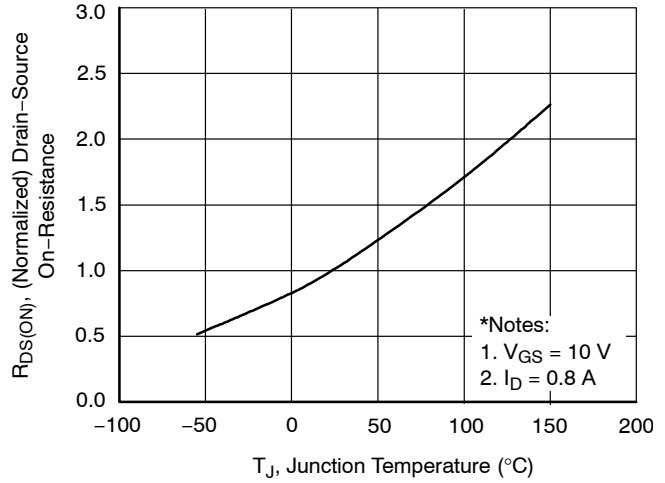

Figure 8. On-Resistance Variation vs. Temperature

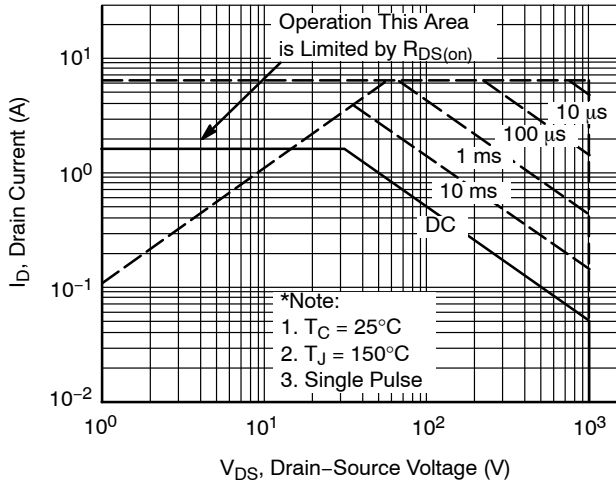

Figure 9. Maximum Safe Operating Area

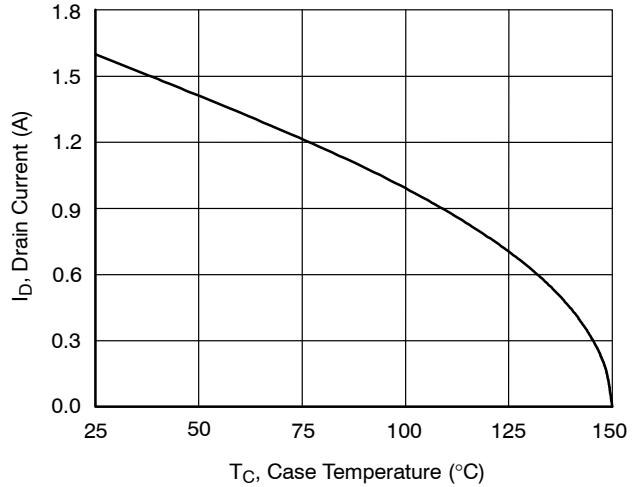

Figure 10. Maximum Drain Current vs. Case Temperature

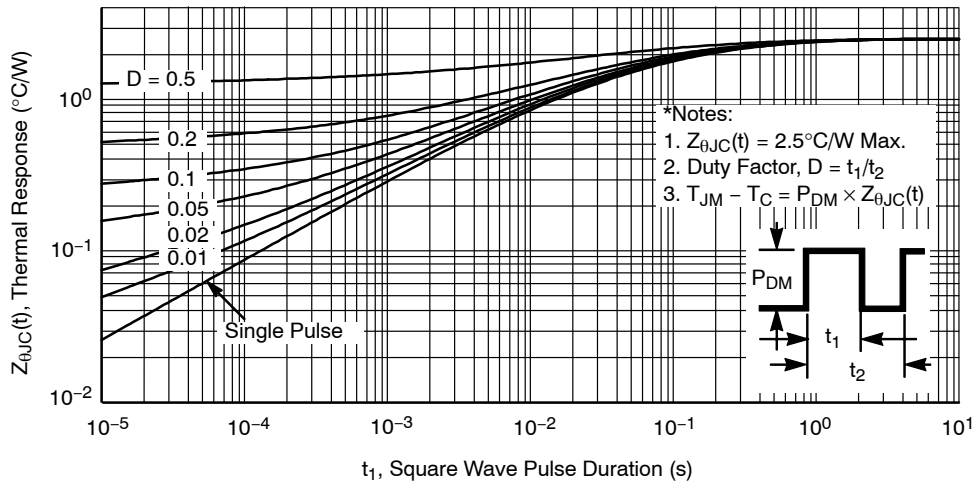

Figure 11. Transient Thermal Response Curve

FQU2N100, FQD2N100

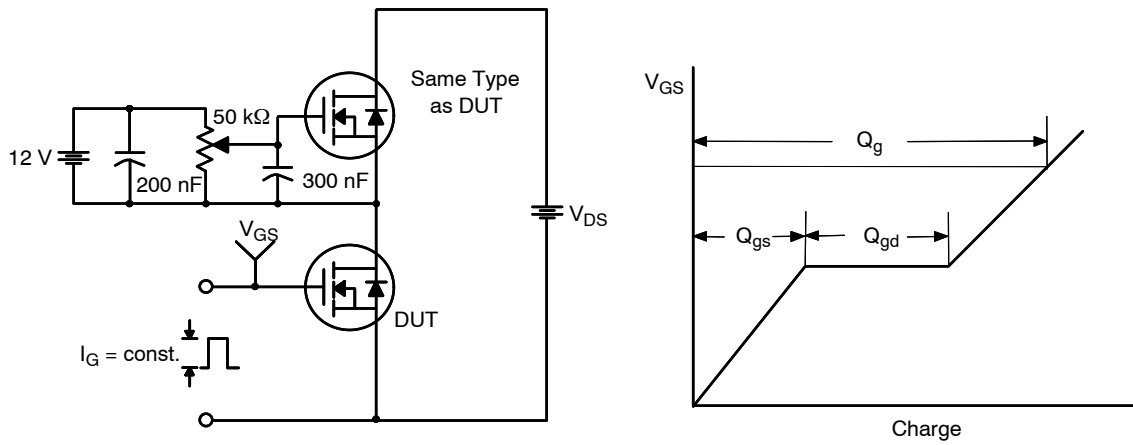

Figure 12. Gate Charge Test Circuit & Waveform

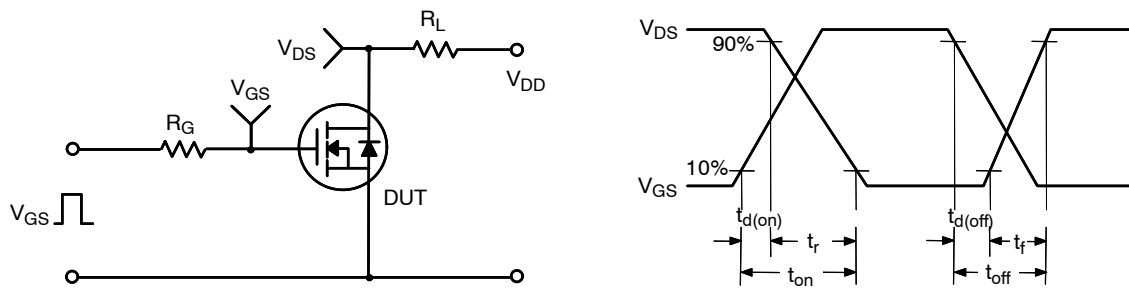

Figure 13. Resistive Switching Test Circuit & Waveforms

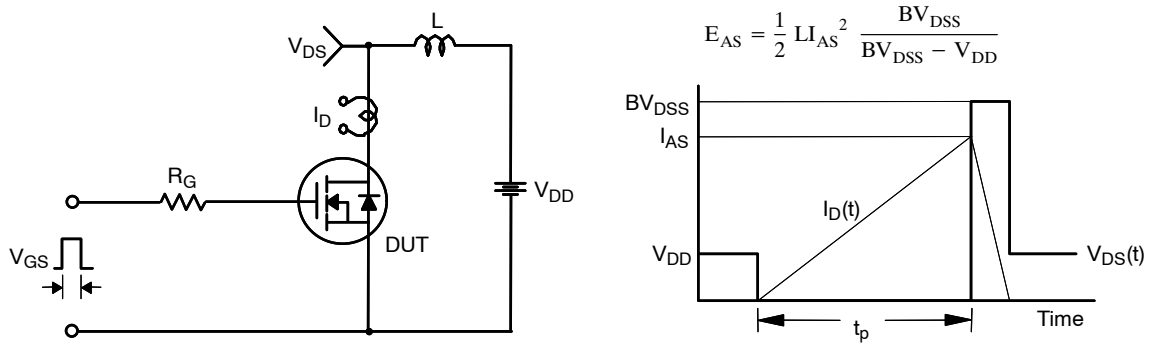

Figure 14. Unclamped Inductive Switching Test Circuit & Waveforms

FQU2N100, FQD2N100

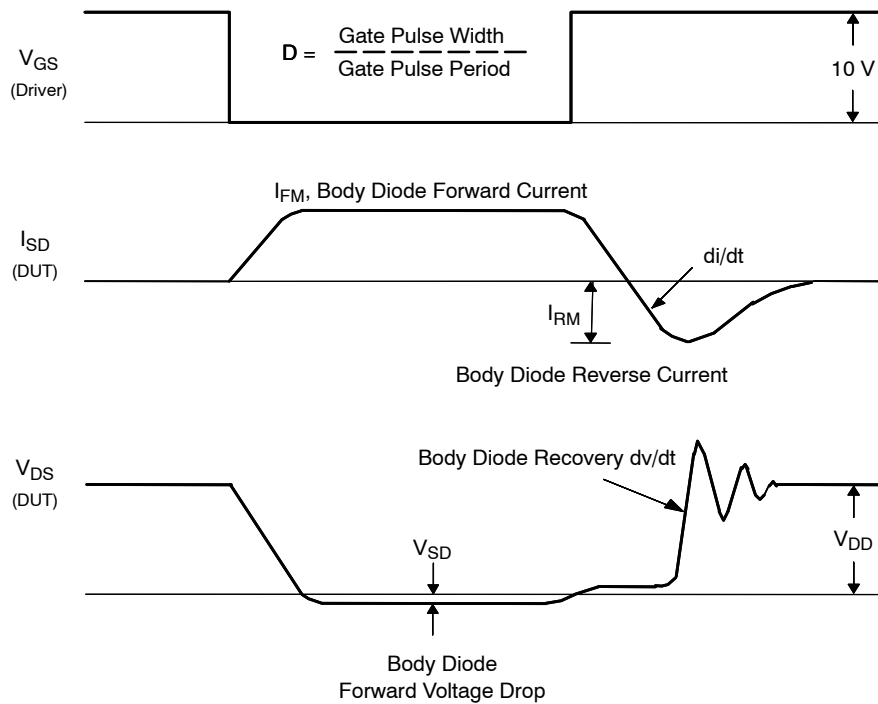
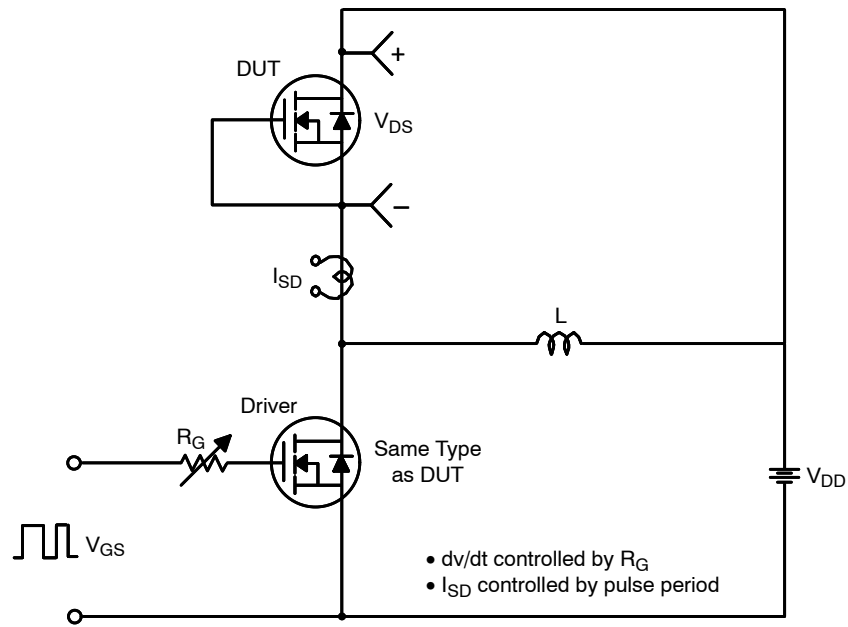

Figure 15. Peak Diode Recovery dv/dt Test Circuit & Waveforms

MECHANICAL CASE OUTLINE
PACKAGE DIMENSIONS

ON Semiconductor®



DPAK3 (IPAK)
CASE 369AR
ISSUE O

DATE 30 SEP 2016

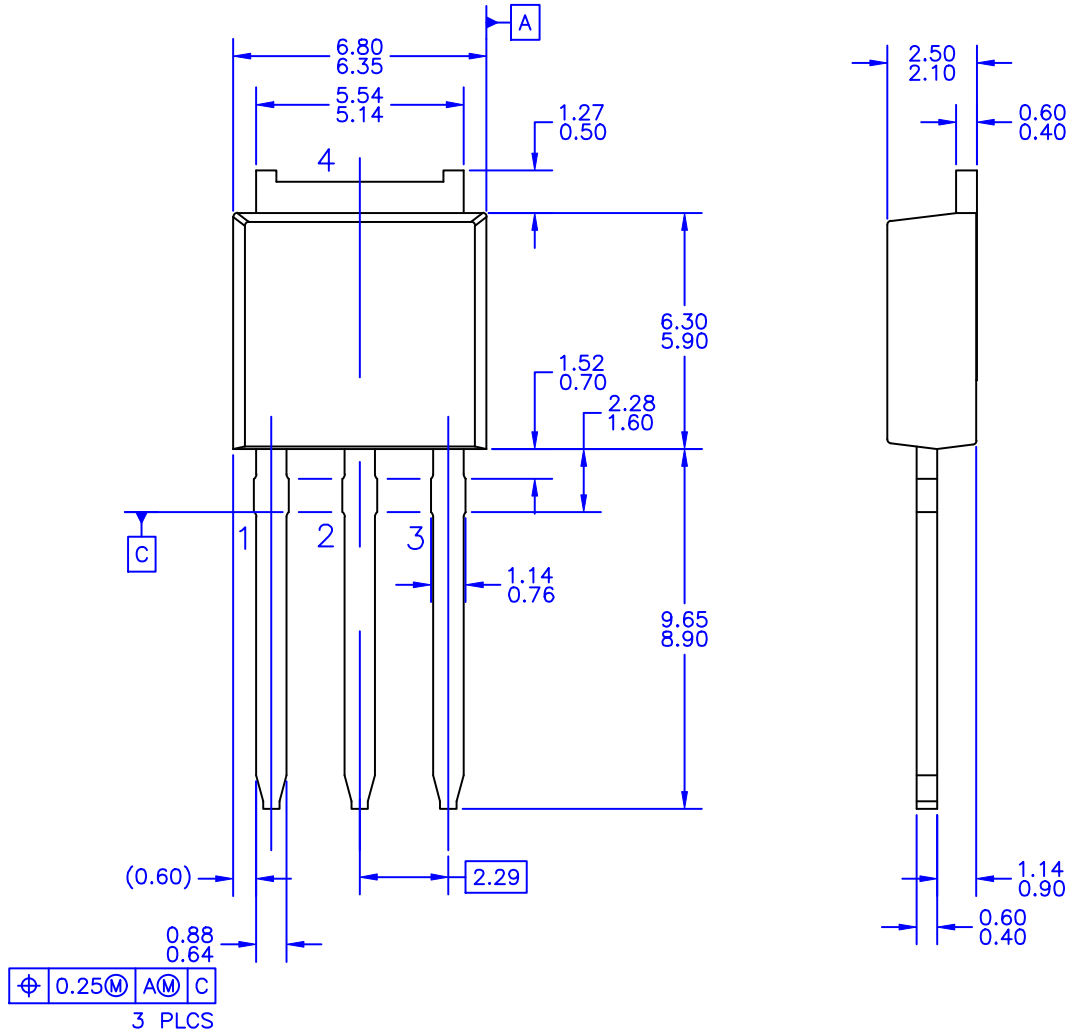

NOTES: UNLESS OTHERWISE SPECIFIED

- A) ALL DIMENSIONS ARE IN MILLIMETERS.
- B) THIS PACKAGE CONFORMS TO JEDEC, TO-251, ISSUE C, VARIATION AA, DATED SEP 1988.
- C) DIMENSIONING AND TOLERANCING PER ASME Y14.5M-1994.

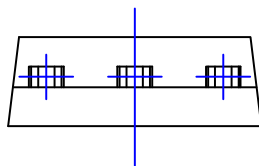

| | | |
|-------------------------|---------------------|---|
| DOCUMENT NUMBER: | 98AON13815G | Electronic versions are uncontrolled except when accessed directly from the Document Repository. Printed versions are uncontrolled except when stamped "CONTROLLED COPY" in red. |
| DESCRIPTION: | DPAK3 (IPAK) | PAGE 1 OF 1 |

ON Semiconductor and are trademarks of Semiconductor Components Industries, LLC dba ON Semiconductor or its subsidiaries in the United States and/or other countries. ON Semiconductor reserves the right to make changes without further notice to any products herein. ON Semiconductor makes no warranty, representation or guarantee regarding the suitability of its products for any particular purpose, nor does ON Semiconductor assume any liability arising out of the application or use of any product or circuit, and specifically disclaims any and all liability, including without limitation special, consequential or incidental damages. ON Semiconductor does not convey any license under its patent rights nor the rights of others.

MECHANICAL CASE OUTLINE PACKAGE DIMENSIONS

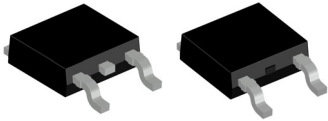

DPAK3 6.10x6.54x2.29, 4.57P CASE 369AS ISSUE B

DATE 20 DEC 2023

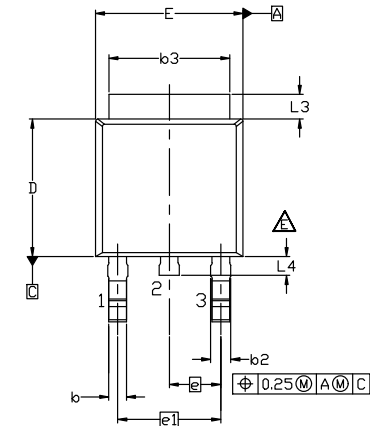

- NOTES: UNLESS OTHERWISE SPECIFIED
 A) THIS PACKAGE CONFORMS TO JEDEC, TO-252, ISSUE F, VARIATION AA.
 B) ALL DIMENSIONS ARE IN MILLIMETERS.
 C) DIMENSIONING AND TOLERANCING PER ASME Y14.5M-2018.
 D) SUPPLIER DEPENDENT MOLD LOCKING HOLES OR CHAMFERED CORNERS OR EDGE PROTRUSION.
 E) FOR DIODE PRODUCTS, L4 IS 0.25 MM MAX PLASTIC BODY STUB WITHOUT CENTER LEAD.
 F) DIMENSIONS ARE EXCLUSIVE OF BURRS, MOLD FLASH AND TIE BAR EXTRUSIONS.
 G) LAND PATTERN RECOMMENDATION IS BASED ON IPC7351A STD TD228P991X239-3N.

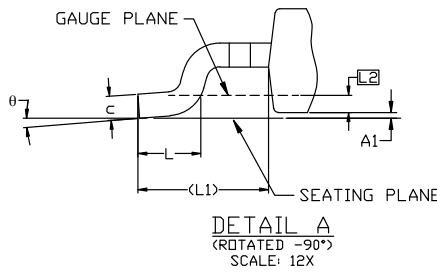
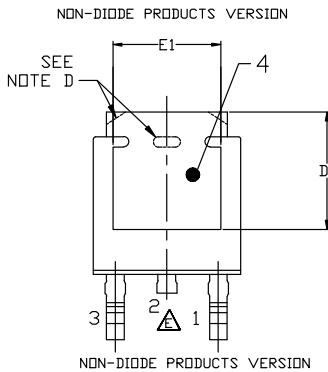

| DIM | MILLIMETERS | | |
|-----|-------------|------|-------|
| | MIN. | NOM. | MAX. |
| A | 2.18 | 2.29 | 2.39 |
| A1 | 0.00 | - | 0.127 |
| b | 0.64 | 0.77 | 0.89 |
| b2 | 0.76 | 0.95 | 1.14 |
| b3 | 5.21 | 5.34 | 5.46 |
| c | 0.45 | 0.53 | 0.61 |
| c2 | 0.45 | 0.52 | 0.58 |
| D | 5.97 | 6.10 | 6.22 |
| D1 | 5.21 | --- | --- |
| E | 6.35 | 6.54 | 6.73 |
| E1 | 4.32 | --- | --- |
| e | 2.286 BSC | | |
| e1 | 4.572 BSC | | |
| H | 9.40 | 9.91 | 10.41 |
| L | 1.40 | 1.59 | 1.78 |
| L1 | 2.90 REF | | |
| L2 | 0.51 BSC | | |
| L3 | 0.89 | 1.08 | 1.27 |
| L4 | --- | --- | 1.02 |
| θ | 0° | --- | 10° |

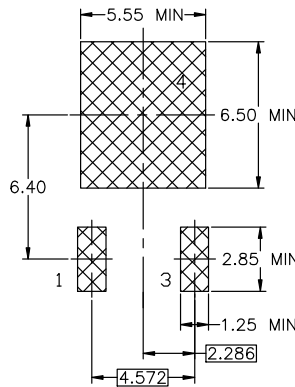

LAND PATTERN RECOMMENDATION

*FOR ADDITIONAL INFORMATION ON OUR PB-FREE STRATEGY AND SOLDERING DETAILS, PLEASE DOWNLOAD THE ON SEMICONDUCTOR SOLDERING AND MOUNTING TECHNIQUES REFERENCE MANUAL, SOLDERM/D.

GENERIC MARKING DIAGRAM*

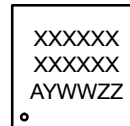

*This information is generic. Please refer to device data sheet for actual part marking. Pb-free indicator, "G" or microdot "•", may or may not be present. Some products may not follow the Generic Marking.

XXXX = Specific Device Code
 A = Assembly Location
 Y = Year
 WW = Work Week
 ZZ = Assembly Lot Code

| | | |
|-------------------------|------------------------------------|--|
| DOCUMENT NUMBER: | 98AON13810G | Electronic versions are uncontrolled except when accessed directly from the Document Repository. Printed versions are uncontrolled except when stamped "CONTROLLED COPY" in red. |
| DESCRIPTION: | DPAK3 6.10x6.54x2.29, 4.57P | PAGE 1 OF 1 |

onsemi and ONSEMI are trademarks of Semiconductor Components Industries, LLC dba onsemi or its subsidiaries in the United States and/or other countries. onsemi reserves the right to make changes without further notice to any products herein. onsemi makes no warranty, representation or guarantee regarding the suitability of its products for any particular purpose, nor does onsemi assume any liability arising out of the application or use of any product or circuit, and specifically disclaims any and all liability, including without limitation special, consequential or incidental damages. onsemi does not convey any license under its patent rights nor the rights of others.

onsemi, **Onsemi**, and other names, marks, and brands are registered and/or common law trademarks of Semiconductor Components Industries, LLC dba "**onsemi**" or its affiliates and/or subsidiaries in the United States and/or other countries. **onsemi** owns the rights to a number of patents, trademarks, copyrights, trade secrets, and other intellectual property. A listing of **onsemi**'s product/patent coverage may be accessed at www.onsemi.com/site/pdf/Patent-Marking.pdf. **onsemi** reserves the right to make changes at any time to any products or information herein, without notice. The information herein is provided "as-is" and **onsemi** makes no warranty, representation or guarantee regarding the accuracy of the information, product features, availability, functionality, or suitability of its products for any particular purpose, nor does **onsemi** assume any liability arising out of the application or use of any product or circuit, and specifically disclaims any and all liability, including without limitation special, consequential or incidental damages. Buyer is responsible for its products and applications using **onsemi** products, including compliance with all laws, regulations and safety requirements or standards, regardless of any support or applications information provided by **onsemi**. "Typical" parameters which may be provided in **onsemi** data sheets and/or specifications can and do vary in different applications and actual performance may vary over time. All operating parameters, including "Typicals" must be validated for each customer application by customer's technical experts. **onsemi** does not convey any license under any of its intellectual property rights nor the rights of others. **onsemi** products are not designed, intended, or authorized for use as a critical component in life support systems or any FDA Class 3 medical devices or medical devices with a same or similar classification in a foreign jurisdiction or any devices intended for implantation in the human body. Should Buyer purchase or use **onsemi** products for any such unintended or unauthorized application, Buyer shall indemnify and hold **onsemi** and its officers, employees, subsidiaries, affiliates, and distributors harmless against all claims, costs, damages, and expenses, and reasonable attorney fees arising out of, directly or indirectly, any claim of personal injury or death associated with such unintended or unauthorized use, even if such claim alleges that **onsemi** was negligent regarding the design or manufacture of the part. **onsemi** is an Equal Opportunity/Affirmative Action Employer. This literature is subject to all applicable copyright laws and is not for resale in any manner.

ADDITIONAL INFORMATION

TECHNICAL PUBLICATIONS:

Technical Library: www.onsemi.com/design/resources/technical-documentation
onsemi Website: www.onsemi.com

ONLINE SUPPORT: www.onsemi.com/support

For additional information, please contact your local Sales Representative at www.onsemi.com/support/sales