

Current Limit Switch, with OVP and TRCB, 28 V / 5 A Rated

FPF2895C



WLCSP24 2.6x1.67x0.612
CASE 567TQ

Description

The FPF2895C features a 28 V and 5 A rated current limit power switch, which offers Over-Current Protection (OCP), Over-Voltage Protection (OVP), and True Reverse Current Block (TRCB) to protect system. It has low On-resistance of typical 27 mΩ with WL-CSP can operate over an input voltage range of 4 V to 22 V.

The FPF2895C supports ±10% of current limit accuracy, flexible operations such as selectable OVP, selectable ON polarity and selectable OCP behavior, which can be optimized according to system requirements.

The FPF2895C is available in a 24-bump, 1.67 mm x 2.60 mm Wafer-Level Chip-Scale Package (WLCSP) with 0.4 mm pitch.

Features

- 28 V / 5 A Capability
- Wide Input Voltage Range: 4 V ~ 22 V
- Ultra Low On-Resistance
 - ◆ Typ. 27 mΩ at 5 V and 25 °C
- Adjustable Current Limit with external RSET
 - ◆ 500 mA ~ 5 A
- Selectable OVLO with OV1 and OV2 Logic Input
 - ◆ 5.95 V ± 50 mV
 - ◆ 10 V ± 100 mV
 - ◆ 16.8 V ± 300 mV
 - ◆ 23 V ± 460 mV
- Selectable ON Polarity
- Selectable Over-Current Behavior
 - ◆ Auto-Restart Mode
 - ◆ Current Source Mode
- True Reverse Current Block
- Thermal Shutdown
- Open Drain Fault FLAGB Output
- UL60950-1, IEC60950-1 and IEC62368-1 Certification 5 A Max Loading
- Robust ESD Capability
 - ◆ 2 kV HBM & 1 kV CDM
 - ◆ 15 kV Air Discharge & 8 kV Contact Discharge under IEC 61000-4-2

Applications

- Laptop, Desktop Computing and Monitor
- Power Accessories

MARKING DIAGRAM

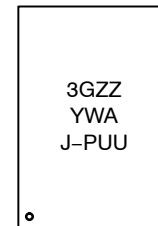

- 3G = Specific Device Code
 - ZZ = Assembly Lot
 - YW = 2-Digits Date Code
 - A = Assembly Location
 - J- = X- Coordinates with dash as separator*
 - P = Y Coordinates*
 - UU = Two Digit Wafer ID*
- *For onsemi internal use only.

PIN CONFIGURATION

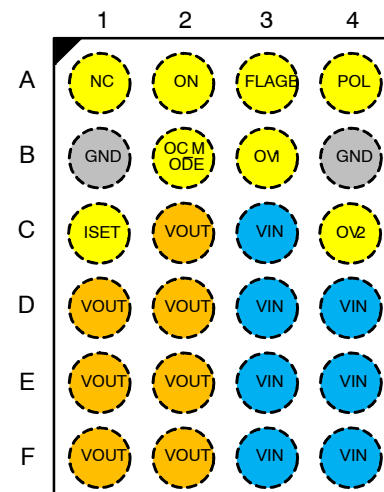

ORDERING INFORMATION

See detailed ordering and shipping information on page 10 of this data sheet.

FPF2895C

Application Diagram

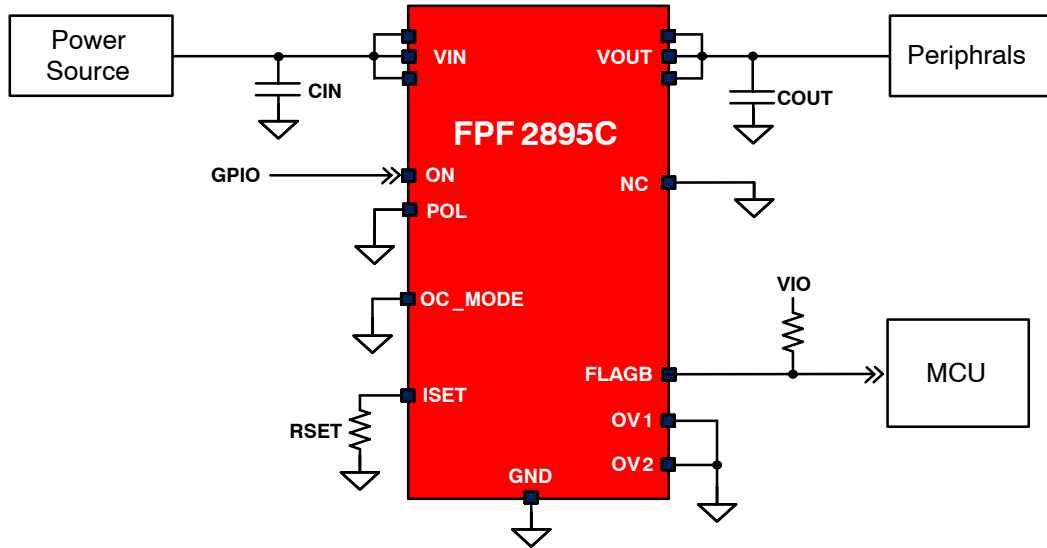

Figure 1. Typical Application

Block Diagram

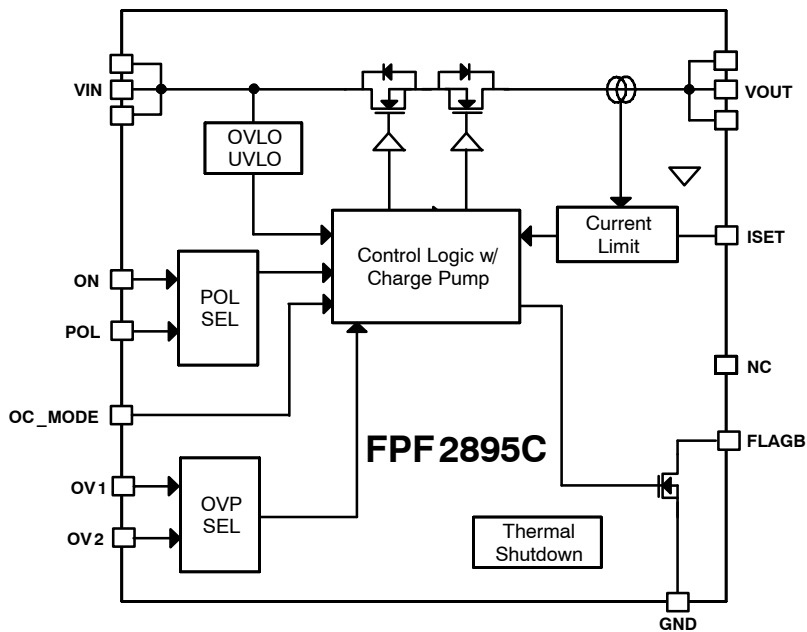

Figure 2. Functional Block Diagram

PIN CONFIGURATION

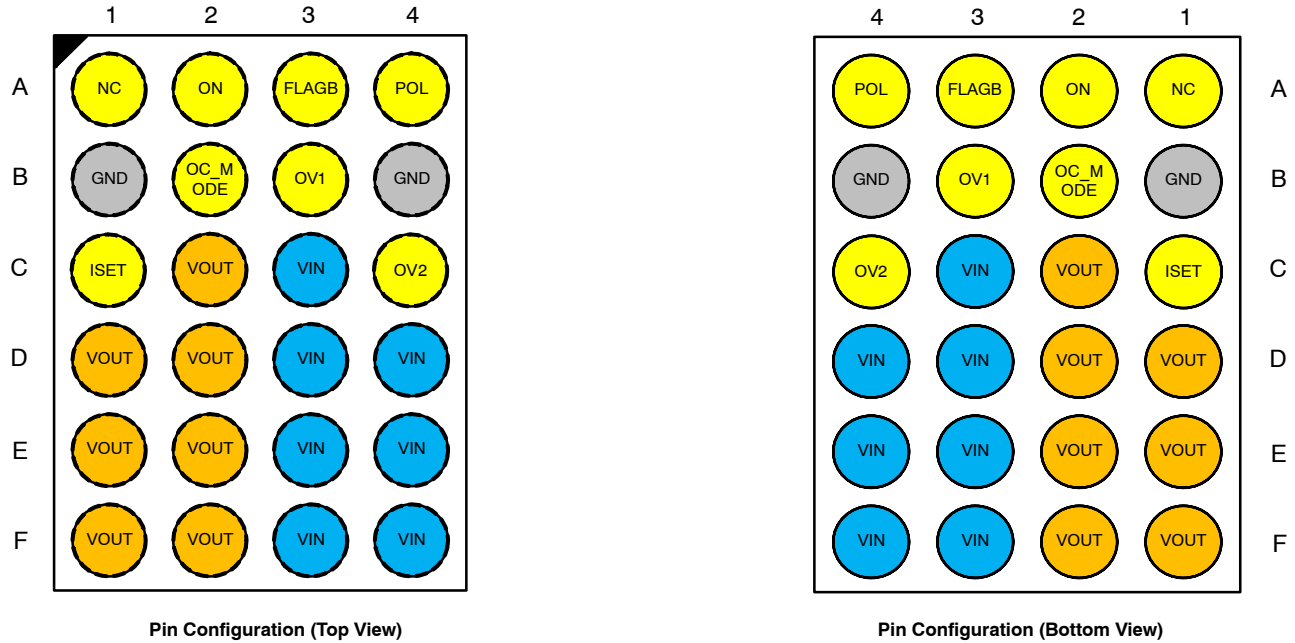

Figure 3. 24 Ball WL_CSP, 4 x 6 Array, 0.4 mm Pitch, 250 μm Ball

Table 1. PIN DEFINITIONS

Name	Bump	Type	Description
VIN	C3, D3, D4, E3, E4, F3, F4	Input/Supply	Switch Input and Device Supply
VOUT	C2, D1, D2, E1, E2, F1, F2	Output	Switch Output to Load
NC	A1	Dummy	Recommended to connect to GND
ON	A2	Input	Internal pull-down resistor of 1 MΩ is included. Active polarity is depending on POL state (Note 1)
POL	A4	Input	Enable Polarity Selection. Internal pull/up of 1 MΩ is included. HIGH (or Floating): Active LOW LOW: Active HIGH (Note 1)
FLAGB	A3	Output	Active LOW, open drain output indicates an over-current, under-voltage, over-voltage, or over-temperature state.
ISET	C1	Input	A resistor from ISET to ground set the current limit for the switch. See below selection Table 6.
OC_MODE	B2	Input	OCP behavior can be selected. Internal pull-up of 1 MΩ is included. HIGH (or Floating): Auto-restart mode during over-current condition. LOW: Current source mode during over-current condition. (Note 1)
OV1	B3	Input	Over-Voltage Selection Input 1. Internal pull-up of 1 MΩ is included and see below selection Table 7. (Note 1)
OV2	C4	Input	Over-Voltage Selection Input 2. Internal pull-up of 1 MΩ is included and see Table 7 (Note 1)
GND	B1, B4	GND	Device Ground

1. To avoid external noise influence when floating, recommend to connect these pins to a certain level.

FPF2895C

Table 2. ABSOLUTE MAXIMUM RATINGS

Symbol	Parameter	Min.	Max.	Unit	
V _{IN} , V _{OUT}	V _{IN} , V _{OUT} to GND	-0.3	28.0	V	
V _{PIN}	ON, POL, OC_MODE, ISET, FLAGB and OV _n to GND	-0.3	6.0	V	
I _{SW}	Continuous Switch Current	-	5.5	A	
t _{PD}	Total Power Dissipation at T _A = 25°C	-	2.08	W	
T _{STG}	Storage Junction Temperature	-65	+150	°C	
T _J	Operating Junction Temperature	-	+150	°C	
T _L	Lead Temperature (Soldering, 10 Seconds)	-	+260	°C	
θ _{JA}	Thermal Resistance, Junction-to-Ambient (1in. ² pad of 2 oz. copper)	-	60 (Note 2)	°C/W	
ESD	Electrostatic Discharge Capability	Human Body Model, ANSI/ESDA/JEDEC JS-001	2	-	kV
		Charged Device Model, JESD22-C101	1	-	
	IEC61000-4-2 System Level	Air Discharge	15	-	
		Contact Discharge	8	-	

Stresses exceeding those listed in the Maximum Ratings table may damage the device. If any of these limits are exceeded, device functionality should not be assumed, damage may occur and reliability may be affected.

2. Measured using 2S2P JEDEC std. PCB.

Table 3. RECOMMENDED OPERATING CONDITIONS

Symbol	Parameter	Min.	Max.	Unit
V _{IN}	Supply Voltage	4.0	22.0	V
C _{IN} / C _{OUT}	Input and Output Capacitance	1.0	-	μF
T _A	Ambient Operating Temperature	-40	+85	°C

Functional operation above the stresses listed in the Recommended Operating Ranges is not implied. Extended exposure to stresses beyond the Recommended Operating Ranges limits may affect device reliability.

Table 4. ELECTRICAL CHARACTERISTICS (Unless otherwise noted, V_{IN} = 4 to 22 V, T_A = -40 to 85°C; typical values are at V_{IN} = 5 V, C_{IN} = C_{OUT} = 1 μF, ON = HIGH, POL = OV1 = OV2 = OC_MODE = GND and T_A = 25°C.)

Symbol	Parameter	Conditions	Min.	Typ.	Max.	Unit	
BASIC OPERATION							
V _{IN}	Input Voltage (Note 4)		4	-	22	V	
I _{SD_IN}	V _{IN} Shutdown Current	V _{ON} = OFF, V _{IN} = 5.5 V, V _{OUT} = Short to GND	-	75	100	μA	
I _Q	Quiescent Current	I _{OUT} = 0 mA, V _{ON} = ON	V _{IN} = 5 V	-	270	330	μA
			V _{IN} = 12 V	-	300	400	
			V _{IN} = 20 V	-	350	450	
R _{ON}	On Resistance	T _A = 25°C, I _{OUT} = 1 A	V _{IN} = 5 V	-	27	39	mΩ
			V _{IN} = 12 V	-	27	39	
			V _{IN} = 20 V	-	27	39	
I _{ON}	ON Input Leakage	V _{ON} = V _{IN} or GND	-	-	10	μA	
V _{IH}	Logic Pin Input (ON, POL, OV1, OV2, OC_MODE) High Voltage	V _{IN} = 3 V ~ 23 V	1.2	-	-	V	
V _{IL}	Logic Pin Input (ON, POL, OV1, OV2, OC_MODE) Low Voltage	V _{IN} = 3 V ~ 23 V	-	-	0.4	V	
V _{P_LOW}	FLAGB Output Logic Low Voltage	V _{IN} = 5 V, I _{SINK} = 5 mA	-	0.1	0.2	V	
I _{LKG}	FLAGB Output High, Leakage Current	V _{IN} = 5 V, Switch ON	-	-	1	μA	

FPF2895C

Table 4. ELECTRICAL CHARACTERISTICS (Unless otherwise noted, $V_{IN} = 4$ to 22 V, $T_A = -40$ to 85°C ; typical values are at $V_{IN} = 5$ V, $C_{IN} = C_{OUT} = 1$ μF , ON = HIGH, POL = OV1 = OV2 = OC_MODE = GND and $T_A = 25^\circ\text{C}$.)

PROTECTIONS

I _{LIM}	Current Limit (Note 3)	$V_{IN} = 5$ V, $V_{OUT} = 4$ V, $R_{SET} = 3.01$ k Ω , $T_A = -40$ to 85°C	1.35	1.50	1.65	A	
		$V_{IN} = 5$ V, $V_{OUT} = 4$ V, $R_{SET} = 1.54$ k Ω , $T_A = -40$ to 85°C	2.85	3.00	3.15		
V _{FOLD}	ILIM Foldback Trip Voltage (Note 3)	V _{OUT} under ILIM Mode	–	2	–	V	
I _{FOLD}	ILIM Foldback Current (Note 3)	$V_{IN} = 5$ V, $V_{OUT} < V_{FOLD}$, $T_A = 25^\circ\text{C}$, OC_MODE = HIGH	–	500	–	mA	
		$V_{IN} = 5$ V, $V_{OUT} < V_{FOLD}$, $T_A = 25^\circ\text{C}$, OC_MODE = LOW	–	250	–	mA	
V _{UVLO}	Under-Voltage Lockout	V _{IN} Increasing	–	2.70	2.95	V	
		V _{IN} Decreasing	–	2.5	–		
	UVLO Hysteresis		–	200	–	mV	
V _{OVLO}	Over-Voltage Lockout (Note 3)	OV1 = LOW, OV2 = LOW	V _{IN} Rising	22.20	23.00	23.46	V
			V _{IN} Falling	22.00	–	–	
		OV1 = LOW, OV2 = HIGH	V _{IN} Rising	9.80	10.00	10.10	
			V _{IN} Falling	9.75	–	–	
		OV1 = HIGH, OV2 = LOW	V _{IN} Rising	16.30	16.80	17.10	
			V _{IN} Falling	16.10	–	–	
		OV1 = HIGH, OV2 = HIGH	V _{IN} Rising	5.85	5.95	6.00	
			V _{IN} Falling	5.80	–	–	
T _{OVP}	OVP Response Time (Note 3)	$R_L = 100$ Ω , $C_L = 0$ μF , $V_{IN} > V_{OVLO}$ to $V_{OUT} = 0.9 \times V_{IN}$	–	–	150	ns	
V _{T_RCB}	TRCB Protection Trip Point	$V_{OUT} - V_{IN}$	–	25	40	mV	
V _{R_RCB}	TRCB Protection, Release Point	$V_{IN} - V_{OUT}$	–	25	40	mV	
t _{RCB}	TRCB Response Time (Note 3)	$V_{IN} = 5$ V, $V_{ON} = \text{HIGH/LOW}$	–	5	–	μs	
t _{RCB_Release}	TRCB Release Time (Note 3)	$V_{IN} = 5$ V, Enabled	–	1	–	μs	
t _{OC}	Over Current Response Time (Note 3)	$V_{IN} = 5$ V, Moderate OC	–	20	–	μs	
		$V_{IN} = 5$ V, Hard Short	–	5	–		
I _{SD_OUT}	V _{OUT} Shutdown Current	$V_{ON} = \text{OFF}$, $V_{OUT} = 5$ V, $V_{IN} = \text{Short to GND}$	–	–	2	μA	
TSD	Thermal Shutdown (Note 3)	Shutdown Threshold	–	150	–	$^\circ\text{C}$	
		Hysteresis	–	20	–		

DYNAMIC BEHAVIOR

t _{DON}	Delay On Time	$R_L = 100$ Ω $C_L = 1$ μF	–	1	–	ms
t _R	V _{OUT} Rise Time	$R_L = 100$ Ω $C_L = 1$ μF	–	1	–	ms
t _{ON}	Turn-On Time	$R_L = 100$ Ω $C_L = 1$ μF	–	2	–	ms
t _{DOFF}	Delay Off Time	$R_L = 100$ Ω $C_L = 1$ μF	–	10	–	μs
t _F	V _{OUT} Fall Time	$R_L = 100$ Ω $C_L = 1$ μF	–	200	–	μs
t _{OFF}	Turn-Off Time	$R_L = 100$ Ω $C_L = 1$ μF	–	210	–	μs
t _{BLANK}	Over-Current Blanking Time (Note 3)	OC_MODE = HIGH	–	5	–	ms
t _{RSTRT}	Auto-Restart Time (Note 3)	OC_MODE = HIGH	–	200	–	ms
t _{QUAL}	Over-Current Qualification Time (Note 3)	OC_MODE = LOW	–	5	–	ms
t _{DEB}	FLAGB De-bounce Time (Note 3)	Restart-up during or after OC	–	3	–	ms
		Restart-up during or after Thermal shutdown	–	15	–	
		Restart-up during or after UVLO	–	1	–	

3. Guaranteed by characterization and design, not production test.

4. To avoid output voltage is coupled to high during cold start, the slew rate of V_{in} should be less than 10 mV/ μs

FPF2895C

Setting Current Limit

FPF2895C current limit is set with an external resistor connected between I_{SET} and GND. This resistor is selected using the following equation:

$$R_{SET} \text{ (k}\Omega\text{)} = 4448.6/I_{lim} \text{ [mA]}$$

Resistor tolerance of 1% or less is recommended.

Table 5. ILIM VS. RSET LOOK-UP TABLE

RSET [kΩ]	ILIM [mA]		
	Min.	Typ.	Max.
8.89	450	500	550
7.41	540	600	660
6.35	630	700	770
5.56	720	800	880
4.94	810	900	990
4.45	900	1000	1100
4.04	990	1100	1210
3.71	1080	1200	1320
3.42	1170	1300	1430
3.18	1260	1400	1540
2.96	1350	1500	1650
2.78	1440	1600	1760
2.62	1530	1700	1870
2.47	1620	1800	1980
2.34	1710	1900	2090
2.22	1800	2000	2200
2.12	1890	2100	2310
2.02	1980	2200	2420
1.93	2070	2300	2530
1.85	2160	2400	2640
1.78	2250	2500	2750
1.71	2340	2600	2860
1.65	2430	2700	2970
1.59	2520	2800	3080
1.53	2610	2900	3190
1.48	2700	3000	3300
1.43	2790	3100	3410
1.39	2880	3200	3520
1.35	2970	3300	3630
1.31	3060	3400	3740
1.27	3150	3500	3850
1.24	3240	3600	3960
1.20	3330	3700	4070
1.17	3420	3800	4180
1.14	3510	3900	4290
1.11	3600	4000	4400
1.08	3690	4100	4510
1.06	3780	4200	4620
1.03	3870	4300	4730
1.01	3960	4400	4840

FPF2895C

Table 5. ILIM VS. RSET LOOK-UP TABLE

RSET [kΩ]	ILIM [mA]		
	Min.	Typ.	Max.
0.99 (Note 5)	4050	4500	4950
0.97	4140	4600	5060
0.95	4230	4700	5170
0.93	4320	4800	5280
0.91	4410	4900	5390
0.89	4500	5000	5500

5. Passed UL&CB certification with max. 5 A output current.

Table 6. OVLO LEVEL SELECTION

OV1	OV2	OVLO
LOW	LOW	23 V ± 460 mV
LOW	HIGH (Floating)	10 V ± 100 mV
HIGH (Floating)	LOW	16.8 ± V 300 mV
HIGH (Floating)	HIGH (Floating)	5.95 ± V 50 mV

Table 7. DEVICE ENABLE POLARITY SELECTION

POL	ON	Device State	ON Polarity
LOW	LOW (Floating)	OFF	Active HIGH
LOW	HIGH	ON	
HIGH (Floating)	LOW (Floating)	ON	Active LOW
HIGH (Floating)	HIGH	OFF	

TIMING DIAGRAMS

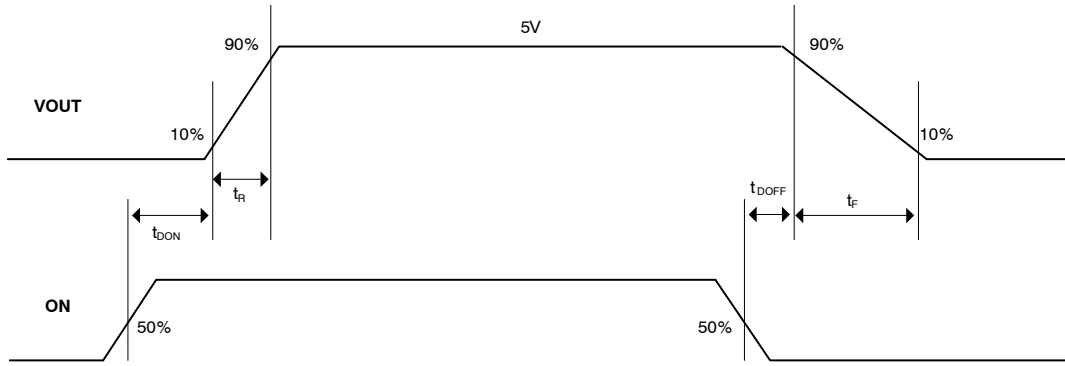

Figure 4. Normal ON/OFF Operation by ON (POL = GND)

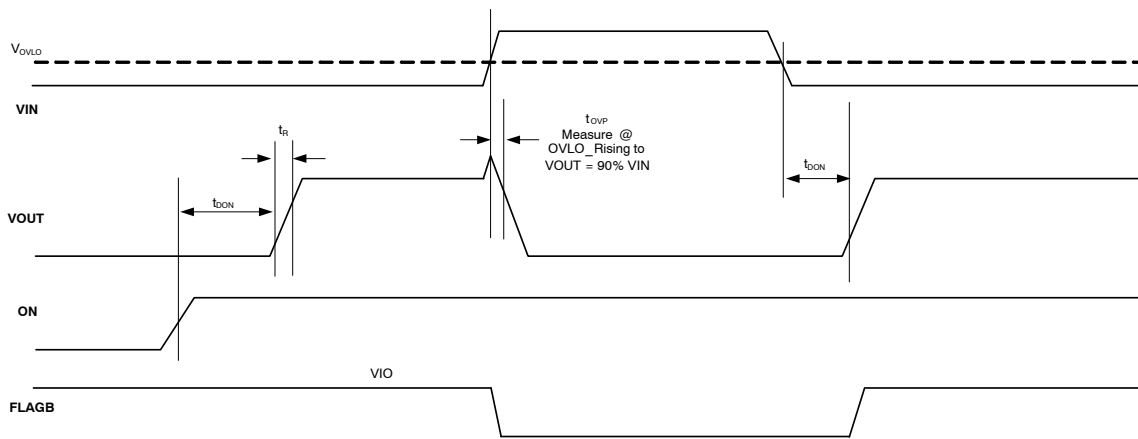

Figure 5. OVLO Operation (POL = GND & FLAGB is Pulled Up With an External VIO)

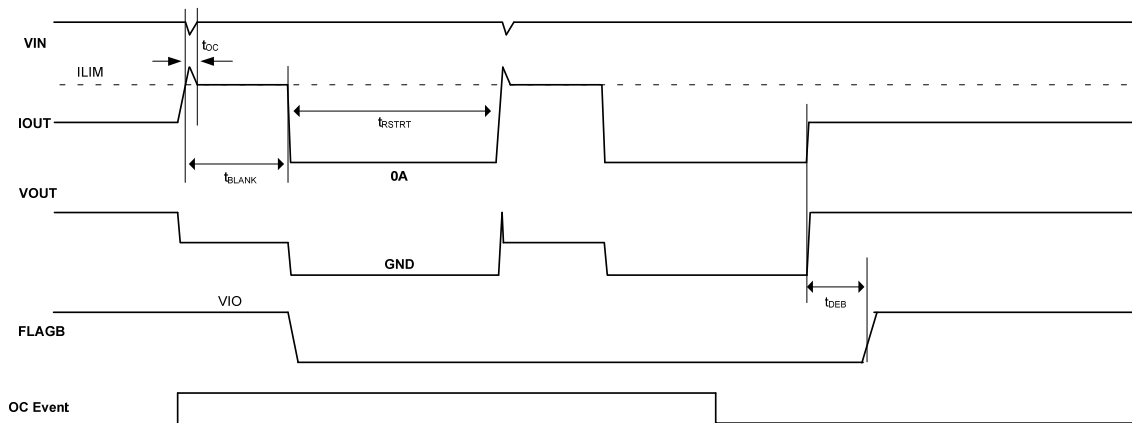

Figure 6. Current Limit Operation (OC_MODE=HIGH & FLAGB is Pulled Up With an External VIO)

FPF2895C

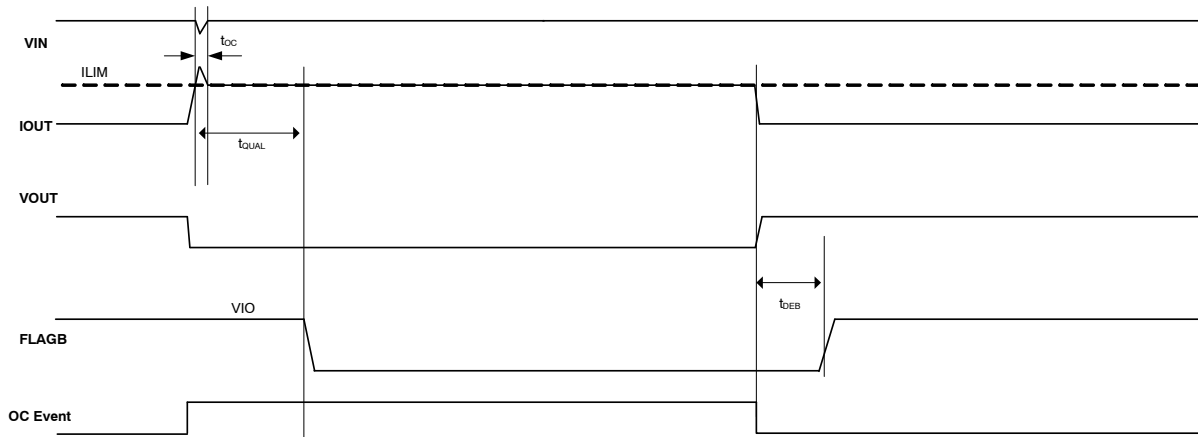

Figure 7. Current Limit Operation (OC_MODE = LOW & FLAGB Is Pulled Up With an External VIO)

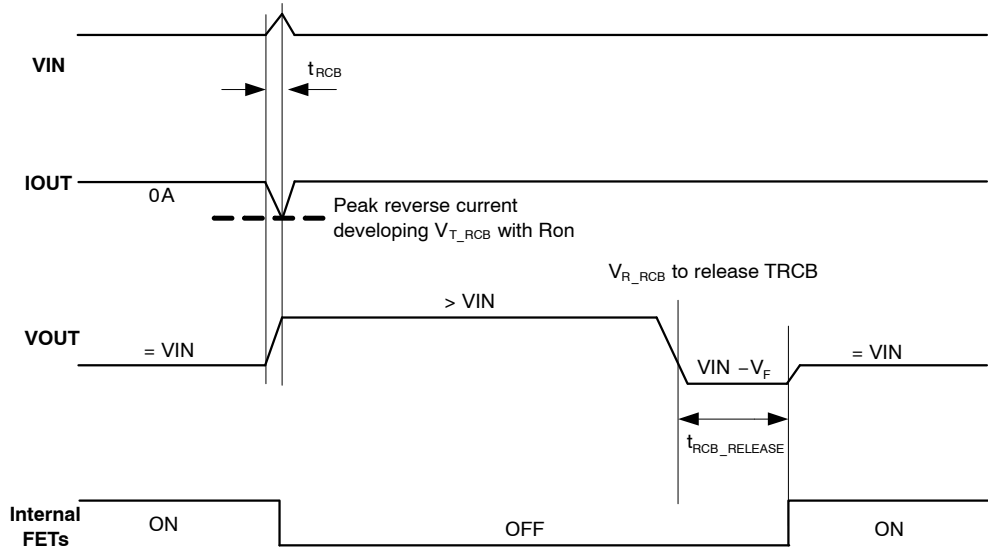

Figure 8. TRCB Operation (Device is Enabled)

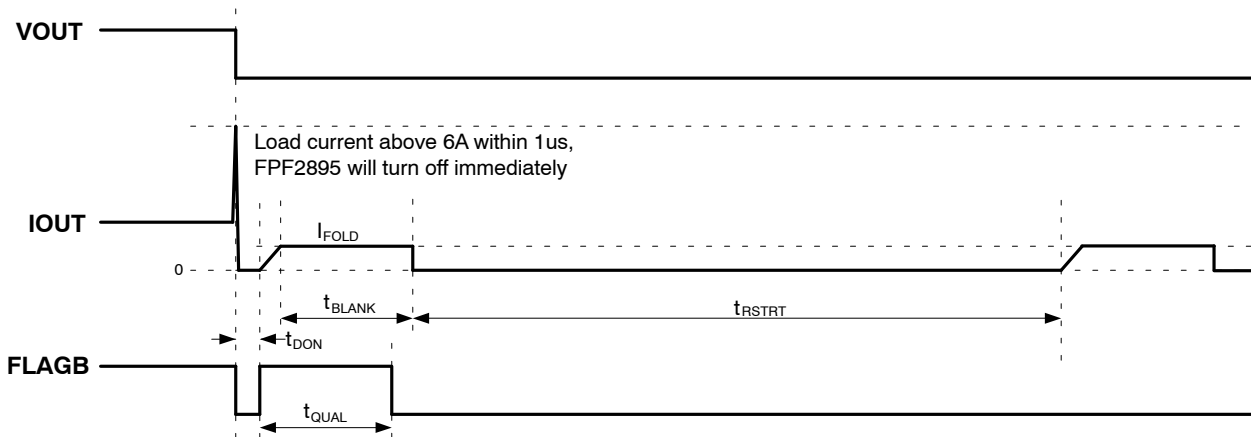

Figure 9. VOUT Hard Short to GND (OC_MODE=HIGH & FLAGB Is Pulled Up With an External VIO)

FPF2895C

PRODUCT-SPECIFIC DIMENSIONS

D	E	X	Y
2600 $\mu\text{m} \pm 30 \mu\text{m}$	1670 $\mu\text{m} \pm 30 \mu\text{m}$	235 $\mu\text{m} \pm 18 \mu\text{m}$	300 $\mu\text{m} \pm 18 \mu\text{m}$

ORDERING INFORMATION

Part Number	Operating Temperature Range	Top Mark	Package	Shipping [†]
FPF2895CUCX	-40°C – +85°C	3G	24-Ball, 0.4 mm Pitch WLCSP	Tape & Reel

[†]For information on tape and reel specifications, including part orientation and tape sizes, please refer to our Tape and Reel Packaging Specifications Brochure, BRD8011/D.



WLCSP24 2.6x1.67x0.612
CASE 567TQ
ISSUE O

DATE 31 MAR 2017

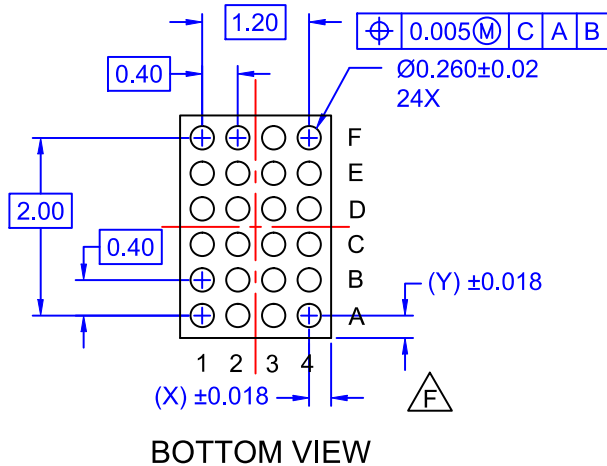
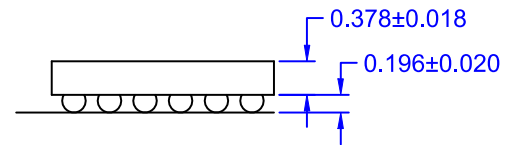
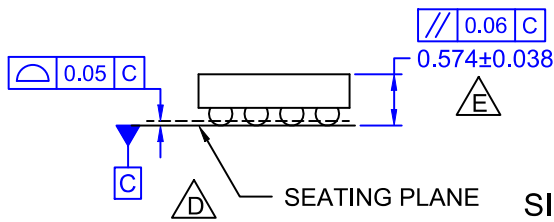
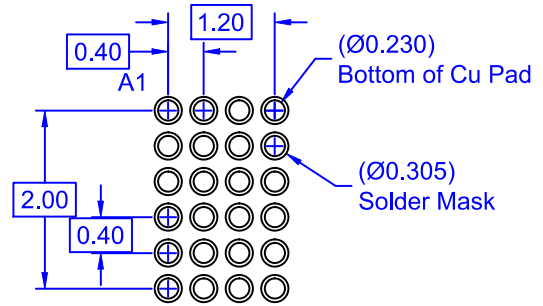
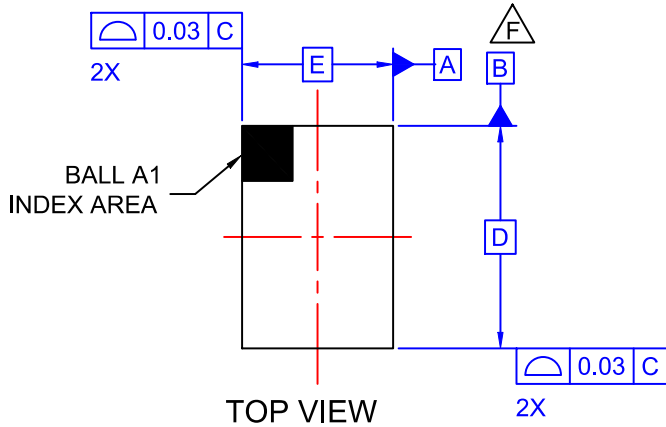

NOTES

- A. NO JEDEC REGISTRATION APPLIES.
- B. DIMENSIONS ARE IN MILLIMETERS.
- C. DIMENSIONS AND TOLERANCE PER ASMEY14.5M, 2009.
- D. DATUM C IS DEFINED BY THE SPHERICAL CROWNS OF THE BALLS.
- E. PACKAGE NOMINAL HEIGHT IS 574 ± 38 MICRONS (536-612 MICRONS).
- F. FOR DIMENSIONS D, E, X, AND Y SEE PRODUCT DATASHEET.

DOCUMENT NUMBER:	98AON13331G	Electronic versions are uncontrolled except when accessed directly from the Document Repository. Printed versions are uncontrolled except when stamped "CONTROLLED COPY" in red.
DESCRIPTION:	WLCSP24 2.6x1.67x0.612	PAGE 1 OF 1

ON Semiconductor and are trademarks of Semiconductor Components Industries, LLC dba ON Semiconductor or its subsidiaries in the United States and/or other countries. ON Semiconductor reserves the right to make changes without further notice to any products herein. ON Semiconductor makes no warranty, representation or guarantee regarding the suitability of its products for any particular purpose, nor does ON Semiconductor assume any liability arising out of the application or use of any product or circuit, and specifically disclaims any and all liability, including without limitation special, consequential or incidental damages. ON Semiconductor does not convey any license under its patent rights nor the rights of others.

onsemi, **Onsemi**, and other names, marks, and brands are registered and/or common law trademarks of Semiconductor Components Industries, LLC dba "**onsemi**" or its affiliates and/or subsidiaries in the United States and/or other countries. **onsemi** owns the rights to a number of patents, trademarks, copyrights, trade secrets, and other intellectual property. A listing of **onsemi**'s product/patent coverage may be accessed at www.onsemi.com/site/pdf/Patent-Marking.pdf. **onsemi** reserves the right to make changes at any time to any products or information herein, without notice. The information herein is provided "as-is" and **onsemi** makes no warranty, representation or guarantee regarding the accuracy of the information, product features, availability, functionality, or suitability of its products for any particular purpose, nor does **onsemi** assume any liability arising out of the application or use of any product or circuit, and specifically disclaims any and all liability, including without limitation special, consequential or incidental damages. Buyer is responsible for its products and applications using **onsemi** products, including compliance with all laws, regulations and safety requirements or standards, regardless of any support or applications information provided by **onsemi**. "Typical" parameters which may be provided in **onsemi** data sheets and/or specifications can and do vary in different applications and actual performance may vary over time. All operating parameters, including "Typicals" must be validated for each customer application by customer's technical experts. **onsemi** does not convey any license under any of its intellectual property rights nor the rights of others. **onsemi** products are not designed, intended, or authorized for use as a critical component in life support systems or any FDA Class 3 medical devices or medical devices with a same or similar classification in a foreign jurisdiction or any devices intended for implantation in the human body. Should Buyer purchase or use **onsemi** products for any such unintended or unauthorized application, Buyer shall indemnify and hold **onsemi** and its officers, employees, subsidiaries, affiliates, and distributors harmless against all claims, costs, damages, and expenses, and reasonable attorney fees arising out of, directly or indirectly, any claim of personal injury or death associated with such unintended or unauthorized use, even if such claim alleges that **onsemi** was negligent regarding the design or manufacture of the part. **onsemi** is an Equal Opportunity/Affirmative Action Employer. This literature is subject to all applicable copyright laws and is not for resale in any manner.

ADDITIONAL INFORMATION

TECHNICAL PUBLICATIONS:

Technical Library: www.onsemi.com/design/resources/technical-documentation
onsemi Website: www.onsemi.com

ONLINE SUPPORT: www.onsemi.com/support

For additional information, please contact your local Sales Representative at www.onsemi.com/support/sales