

FDMS3660S

PowerTrench[®] Power Stage Asymmetric Dual N-Channel MOSFET

Description

This device includes two specialized N-Channel MOSFETs in a dual PQFN package. The switch node has been internally connected to enable easy placement and routing of synchronous buck converters. The control MOSFET (Q1) and synchronous SyncFET (Q2) have been designed to provide optimal power efficiency.

Features

Q1: N-Channel

- Max $r_{DS(on)}$ = 8 m Ω at $V_{GS} = 10$ V, $I_D = 13$ A
- Max $r_{DS(on)}$ = 11 m Ω at $V_{GS} = 4.5$ V, $I_D = 11$ A

Q2: N-Channel

- Max $r_{DS(on)}$ = 1.8 m Ω at $V_{GS} = 10$ V, $I_D = 30$ A
- Max $r_{DS(on)}$ = 2.2 m Ω at $V_{GS} = 4.5$ V, $I_D = 27$ A
- Low Inductance Packaging Shortens Rise/Fall Times, Resulting in Lower Switching Losses
- MOSFET Integration Enables Optimum Layout for Lower Circuit Inductance and Reduced Switch Node Ringing
- These Devices are Pb-Free and are RoHS Compliant

Applications

- Computing
- Communications
- General Purpose Point of Load
- Notebook VCORE



ON Semiconductor[®]

www.onsemi.com

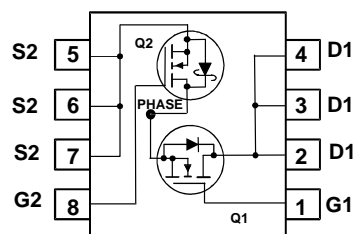
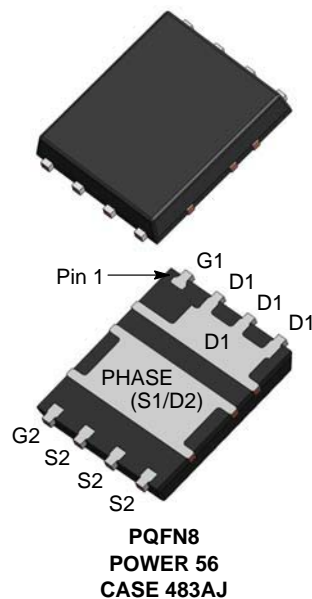

ORDERING INFORMATION

See detailed ordering and shipping information on page 2 of this data sheet.

FDMS3660S

MAXIMUM RATINGS (T_A = 25°C unless otherwise noted)

Symbol	Rating	Q1	Q2	Unit
V _{DS}	Drain to Source Voltage	30	30	V
Bvdsst	Bvdsst (Transient) < 100 ns	36	36	V
V _{GS}	Gate to Source Voltage (Note 3)	±20	±12	V
I _D	Drain Current – Continuous (Package limited) (T _C = 25°C)	30	60	A
	Drain Current – Continuous (Silicon limited) (T _C = 25°C)	60	145	
	Drain Current – Continuous (T _A = 25°C)	13 (Note 6a)	30 (Note 6b)	
	Drain Current – Pulsed	40	120	
E _{AS}	Single Pulse Avalanche Energy	33 (Note 4)	86 (Note 5)	mJ
P _D	Power Dissipation for Single Operation (T _A = 25°C)	2.2 (Note 6a)	2.5 (Note 6b)	W
	Power Dissipation for Single Operation (T _A = 25°C)	1 (Note 6c)	1 (Note 6d)	
T _J , T _{STG}	Operating and Storage Junction Temperature Range	–55 to +150		°C

Stresses exceeding those listed in the Maximum Ratings table may damage the device. If any of these limits are exceeded, device functionality should not be assumed, damage may occur and reliability may be affected.

THERMAL CHARACTERISTICS

Symbol	Parameter	Q1	Q2	Unit
R _{θJA}	Thermal Resistance, Junction-to-Ambient	57 (Note 6a)	50 (Note 6b)	°C/W
R _{θJA}	Thermal Resistance, Junction-to-Ambient	125 (Note 6c)	120 (Note 6d)	°C/W
R _{θJC}	Thermal Resistance, Junction-to-Case	2.9	2.2	°C/W

PACKAGE MARKING AND ORDERING INFORMATION

Device	Device Marking	Package	Reel Size	Tape Width	Quantity
FDMS3660S	22CF 07OD	Power 56	13"	12 mm	3000 Units

Table 1. ELECTRICAL CHARACTERISTICS T_J = 25°C unless otherwise noted

Symbol	Parameter	Test Conditions	Type	Min	Typ	Max	Units
--------	-----------	-----------------	------	-----	-----	-----	-------

OFF CHARACTERISTICS

BV _{DSS}	Drain to Source Breakdown Voltage	I _D = 250 μA, V _{GS} = 0 V I _D = 1 mA, V _{GS} = 0 V	Q1 Q2	30 30			V
ΔBV _{DSS} /ΔT _J	Breakdown Voltage Temperature Coefficient	I _D = 250 μA, referenced to 25°C I _D = 10 mA, referenced to 25°C	Q1 Q2		16 24		mV/°C
I _{DSS}	Zero Gate Voltage Drain Current	V _{DS} = 24 V, V _{GS} = 0 V	Q1 Q2			1 500	μA μA
I _{GSS}	Gate to Source Leakage Current	V _{GS} = 20 V, V _{DS} = 0 V V _{GS} = 12 V, V _{DS} = 0 V	Q1 Q2			100 100	nA nA

ON CHARACTERISTICS

V _{GS(th)}	Gate to Source Threshold Voltage	V _{GS} = V _{DS} , I _D = 250 μA V _{GS} = V _{DS} , I _D = 1 mA	Q1 Q2	1.1 1.1	1.9 1.5	2.7 2.2	V
ΔV _{GS(th)} /ΔT _J	Gate to Source Threshold Voltage Temperature Coefficient	I _D = 250 μA, referenced to 25°C I _D = 10 mA, referenced to 25°C	Q1 Q2		–6 –3		mV/°C
r _{DS(on)}	Drain to Source On Resistance	V _{GS} = 10 V, I _D = 13 A V _{GS} = 4.5 V, I _D = 11 A V _{GS} = 10 V, I _D = 13 A, T _J = 125°C	Q1		4 6 5.7	8 11 8.7	mΩ
		V _{GS} = 10 V, I _D = 30 A V _{GS} = 4.5 V, I _D = 27 A V _{GS} = 10 V, I _D = 30 A, T _J = 125°C	Q2		1.3 1.5 1.86	1.8 2.2 2.6	

FDMS3660S

Table 1. ELECTRICAL CHARACTERISTICS $T_J = 25^\circ\text{C}$ unless otherwise noted

Symbol	Parameter	Test Conditions	Type	Min	Typ	Max	Units
--------	-----------	-----------------	------	-----	-----	-----	-------

ON CHARACTERISTICS

g _{FS}	Forward Transconductance	V _{DS} = 5 V, I _D = 13 A V _{DS} = 5 V, I _D = 30 A	Q1 Q2		62 231		S
-----------------	--------------------------	--	----------	--	-----------	--	---

DYNAMIC CHARACTERISTICS

C _{iss}	Input Capacitance	Q1: V _{DS} = 15 V, V _{GS} = 0 V, f = 1 MHz	Q1 Q2		1325 4130	1765 5493	pF
C _{oss}	Output Capacitance	Q2: V _{DS} = 15 V, V _{GS} = 0 V, f = 1 MHz	Q1 Q2		466 915	620 1220	pF
C _{riss}	Reverse Transfer Capacitance		Q1 Q2		46 124	70 185	pF
R _g	Gate Resistance		Q1 Q2	0.2 0.2	0.6 0.8	2 3	Ω

SWITCHING CHARACTERISTICS

t _{d(on)}	Turn-On Delay Time	Q1: V _{DD} = 15 V, I _D = 13 A, R _{GEN} = 6 Ω	Q1 Q2		7.7 11	15 20	ns
t _r	Rise Time	Q2: V _{DD} = 15 V, I _D = 30 A, R _{GEN} = 6 Ω	Q1 Q2		2.2 5	10 10	ns
t _{d(off)}	Turn-Off Delay Time		Q1 Q2		19 40	34 64	ns
t _f	Fall Time		Q1 Q2		1.8 3.9	10 10	ns
Q _g	Total Gate Charge	V _{GS} = 0 V to 10 V	Q1 Q2	V _{DD} = 15 V, I _D = 13 A	21 62	29 87	nC
Q _g	Total Gate Charge	V _{GS} = 0 V to 4.5 V	Q1 Q2	V _{DD} = 15 V, I _D = 30 A	9.5 29	13 41	nC
Q _{gs}	Gate to Source Gate Charge	Q1 V _{DD} = 15 V, I _D = 13 A	Q1 Q2		3.9 9		nC
Q _{gd}	Gate to Drain "Miller" Charge	Q2 V _{DD} = 15 V, I _D = 30 A	Q1 Q2		2.6 7		nC

DRAIN-SOURCE DIODE CHARACTERISTICS

V _{SD}	Source to Drain Diode Forward Voltage	V _{GS} = 0 V, I _S = 13 A (Note 2) V _{GS} = 0 V, I _S = 2 A (Note 2) V _{GS} = 0 V, I _S = 30 A (Note 2) V _{GS} = 0 V, I _S = 2 A (Note 2)	Q1 Q1 Q2 Q2		0.8 0.7 0.8 0.6	1.2 1.2 1.2 1.2	V
t _{rr}	Reverse Recovery Time	Q1 I _F = 13 A, di/dt = 100 A/μs	Q1 Q2		26 29	42 46	ns
Q _{rr}	Reverse Recovery Charge	Q2 I _F = 30 A, di/dt = 300 A/μs	Q1 Q2		10 32	20 50	nC

Product parametric performance is indicated in the Electrical Characteristics for the listed test conditions, unless otherwise noted. Product performance may not be indicated by the Electrical Characteristics if operated under different conditions.

1. R_{θJA} is determined with the device mounted on a 1 in² pad 2 oz copper pad on a 1.5 x 1.5 in. board of FR-4 material. R_{θJC} is guaranteed by design while R_{θCA} is determined by the user's board design.
2. Pulse Test: Pulse Width < 300 μs, Duty cycle < 2.0%.
3. As an N-ch device, the negative V_{gs} rating is for low duty cycle pulse occurrence only. No continuous rating is implied with the negative V_{gs} rating.
4. E_{AS} of 33 mJ is based on starting T_J = 25°C; N-ch: L = 1.9 mH, I_{AS} = 6 A, V_{DD} = 27 V, V_{GS} = 10 V. 100% test at L = 0.1 mH, I_{AS} = 16 A.
5. E_{AS} of 86 mJ is based on starting T_J = 25°C; N-ch: L = 0.6 mH, I_{AS} = 17 A, V_{DD} = 27 V, V_{GS} = 10 V. 100% test at L = 0.1 mH, I_{AS} = 31 A.

FDMS3660S

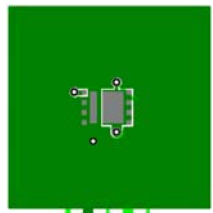

(Note 6a)

G
D
S
S
S

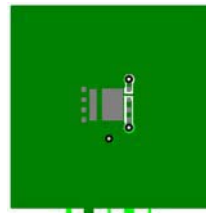

(Note 6b)

G
D
S
S
S



(Note 6c)

G
D
S
S
S

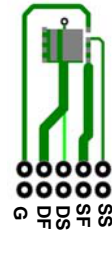

(Note 6d)

G
D
S
S
S

6. a) 57°C/W when mounted on a 1 in² pad of 2 oz copper
- b) 50°C/W when mounted on a 1 in² pad of 2 oz copper
- c) 125°C/W when mounted on a minimum pad of 2 oz copper
- d) 120°C/W when mounted on a minimum pad of 2 oz copper

TYPICAL CHARACTERISTICS (Q1 N-Channel) $T_J = 25^\circ\text{C}$ unless otherwise noted

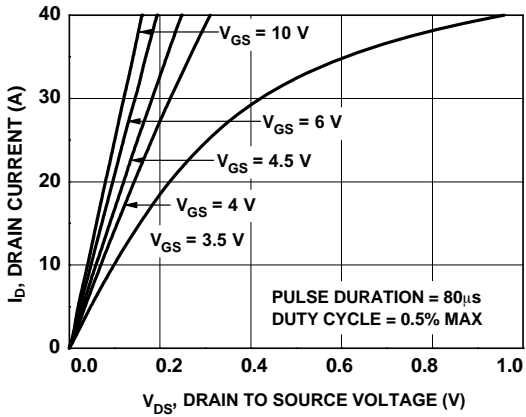

Figure 1. On Region Characteristics

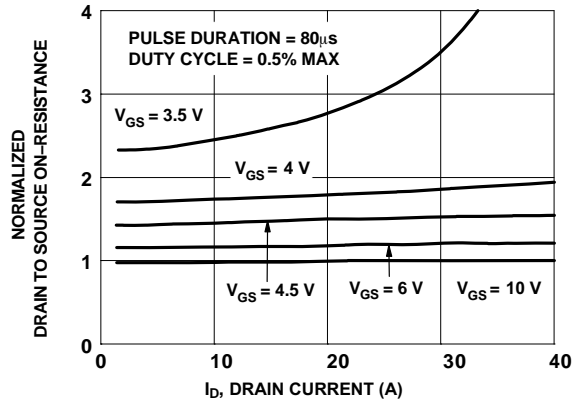

Figure 2. Normalized On-Resistance vs. Drain Current and Gate Voltage

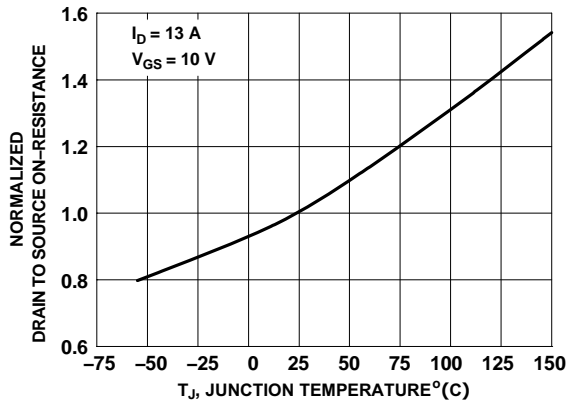

Figure 3. Normalized On Resistance vs. Junction Temperature

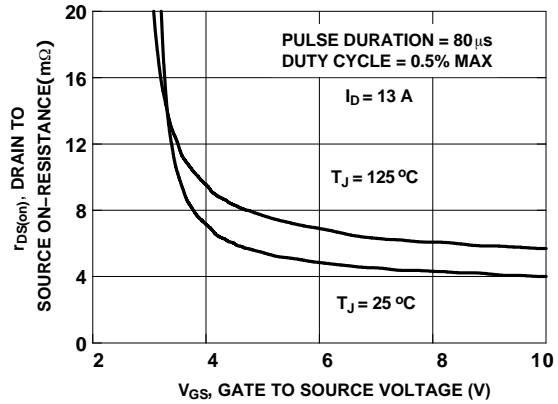

Figure 4. On-Resistance vs. Gate to Source Voltage

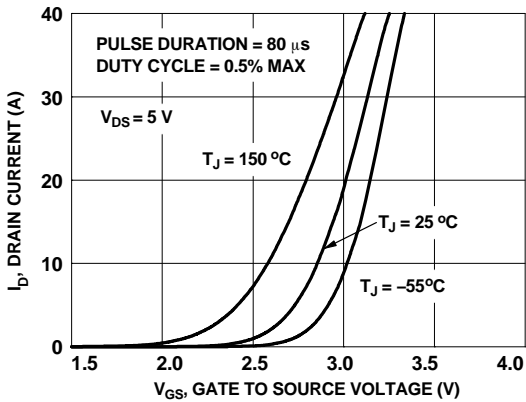

Figure 5. Transfer Characteristics

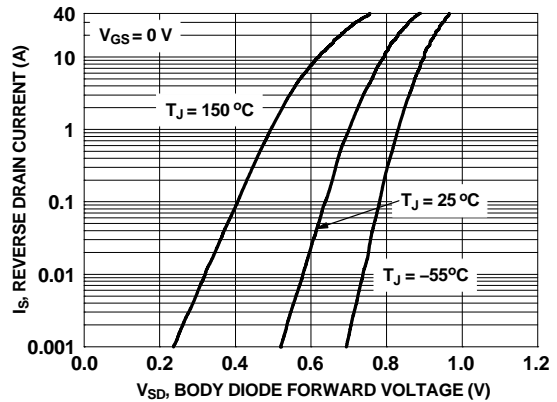

Figure 6. Source to Drain Diode Forward Voltage vs. Source Current

FDMS3660S

TYPICAL CHARACTERISTICS (Q1 N-Channel) $T_J = 25^\circ\text{C}$ unless otherwise noted

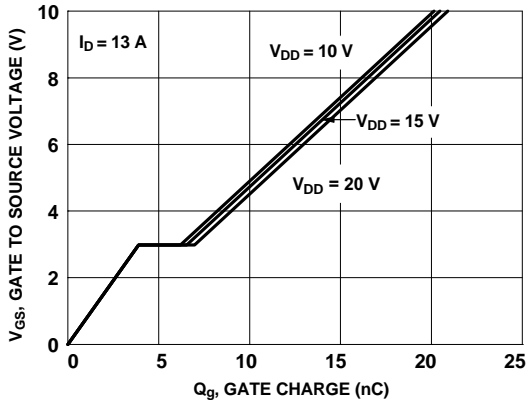

Figure 7. Gate Charge Characteristics

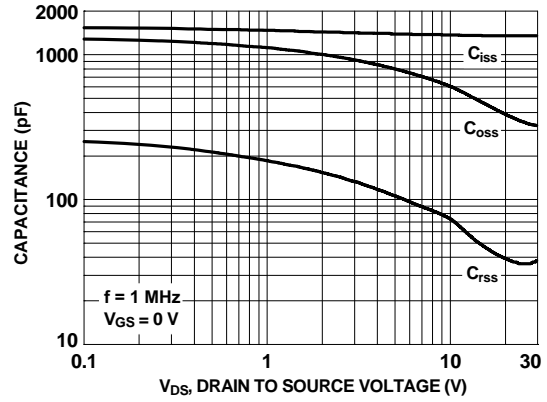

Figure 8. Capacitance vs. Drain to Source Voltage

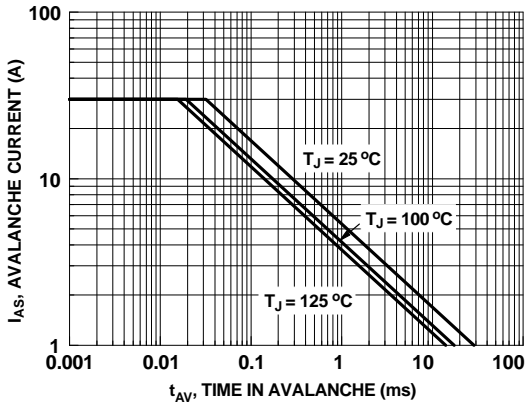

Figure 9. Unclamped Inductive Switching Capability

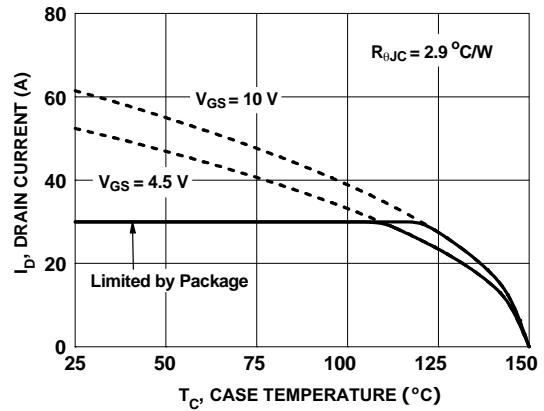

Figure 10. Maximum Continuous Drain Current vs. Case Temperature

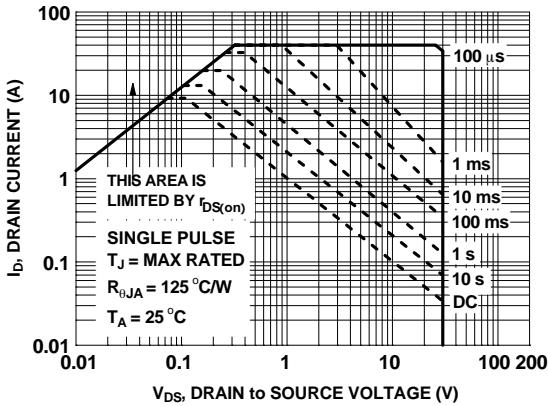

Figure 11. Forward Bias Safe Operating Area

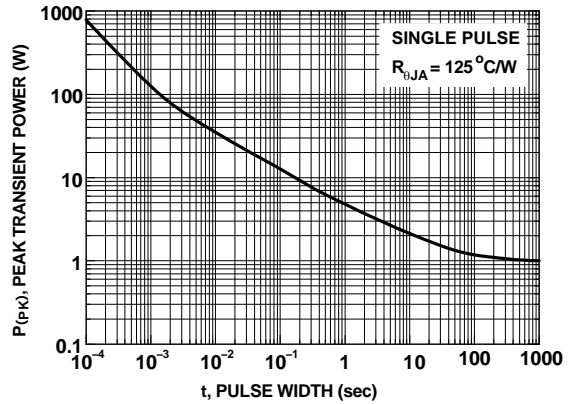

Figure 12. Single Pulse Maximum Power Dissipation

FDMS3660S

TYPICAL CHARACTERISTICS (Q1 N-Channel) $T_J = 25^\circ\text{C}$ unless otherwise noted

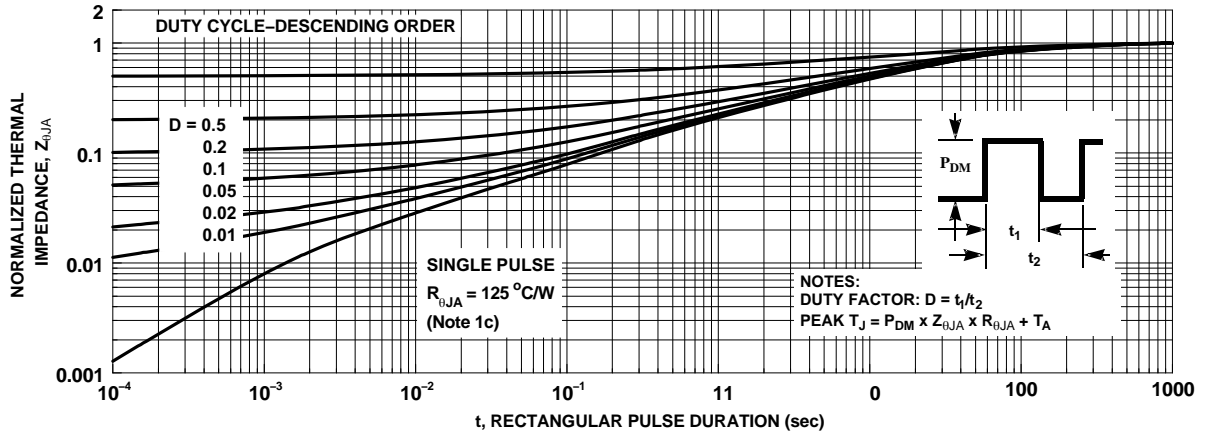

Figure 13. Junction-to-Ambient Transient Thermal Response Curve

TYPICAL CHARACTERISTICS (Q2 N-Channel) $T_J = 25^\circ\text{C}$ unless otherwise noted

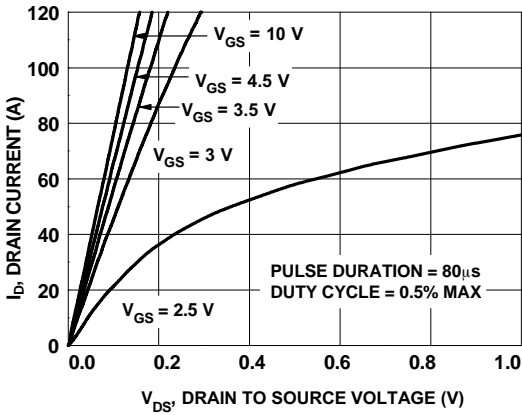

Figure 14. On Region Characteristics

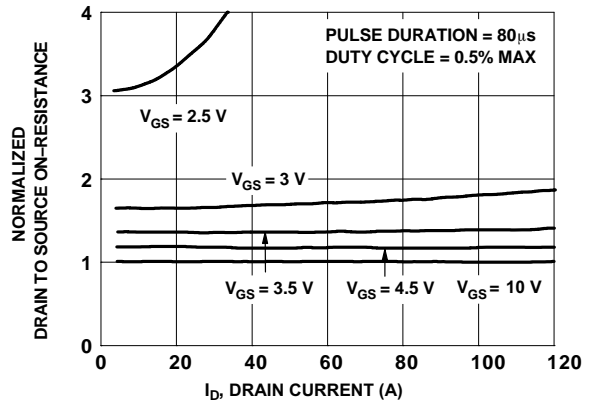

Figure 15. Normalized On-Resistance vs. Drain Current and Gate Voltage

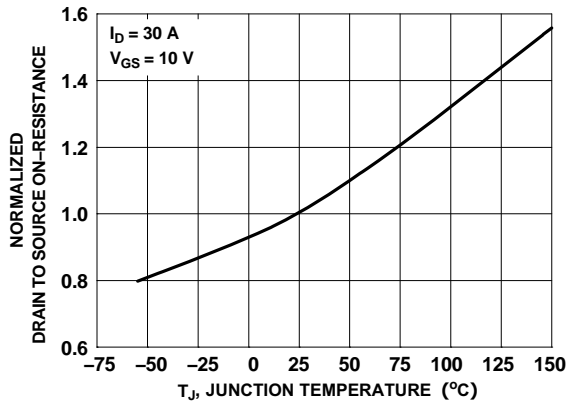

Figure 16. Normalized On-Resistance vs. Junction Temperature

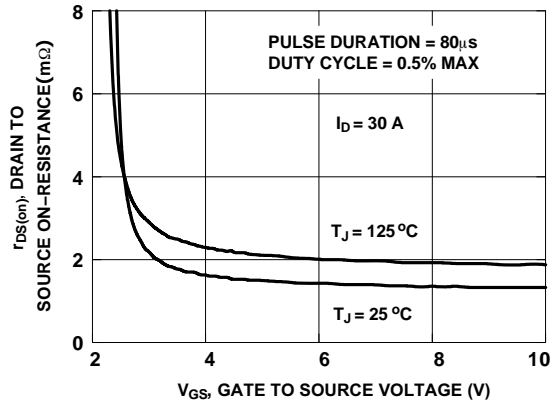

Figure 17. On-Resistance vs. Gate to Source Voltage

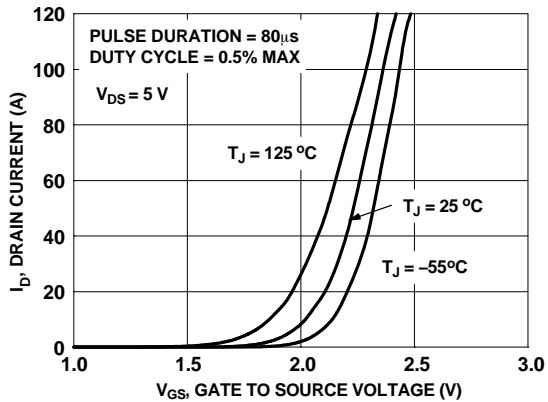

Figure 18. Transfer Characteristics

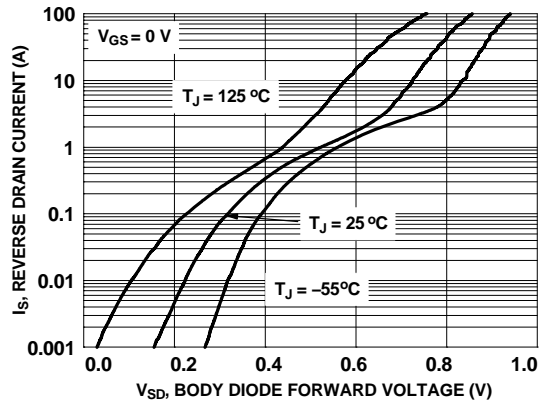

Figure 19. Source to Drain Diode Forward Voltage vs. Source Current

TYPICAL CHARACTERISTICS (Q2 N-Channel) $T_J = 25^\circ\text{C}$ unless otherwise noted

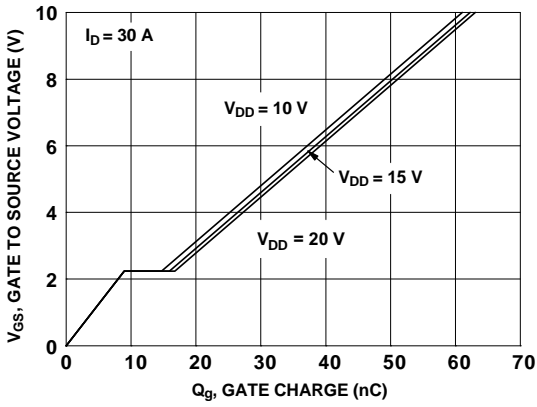

Figure 20. Gate Charge Characteristics

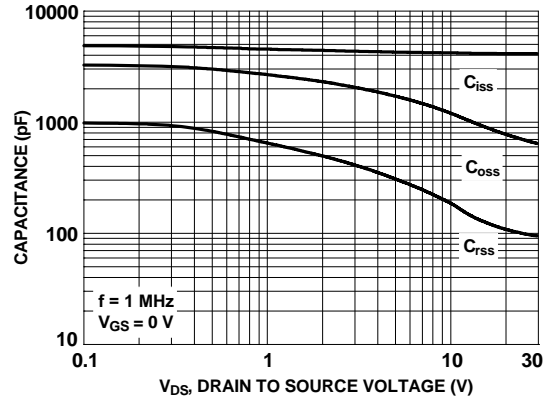

Figure 21. Capacitance vs. Drain to Source Voltage

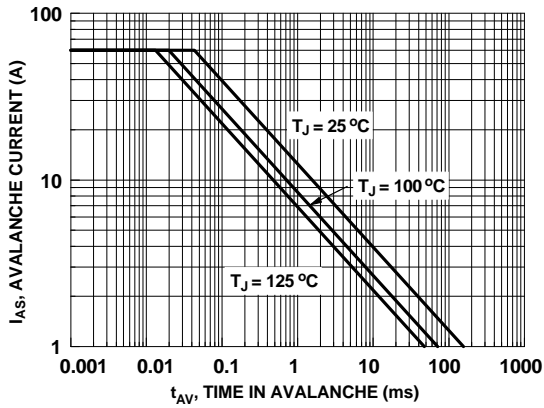

Figure 22. Unclamped Inductive Switching Capability

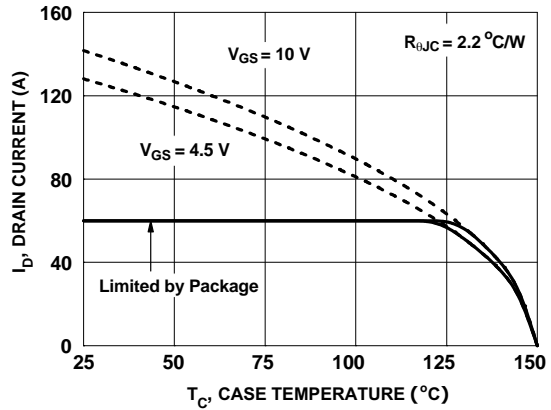

Figure 23. Maximum Continuous Drain Current vs. Case Temperature

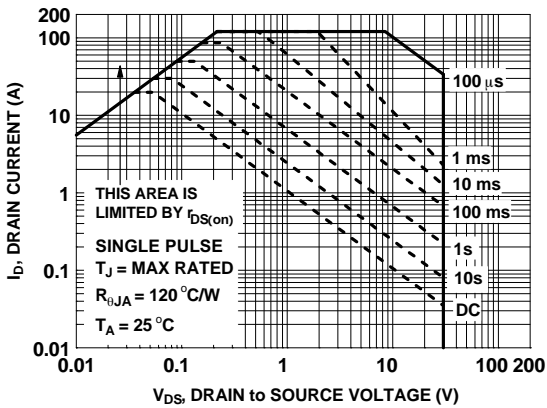

Figure 24. Forward Bias Safe Operating Area

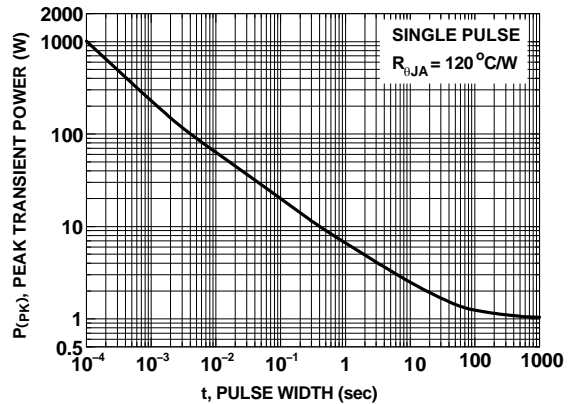

Figure 25. Single Pulse Maximum Power Dissipation

FDMS3660S

TYPICAL CHARACTERISTICS (Q2 N-Channel) $T_J = 25^\circ\text{C}$ unless otherwise noted

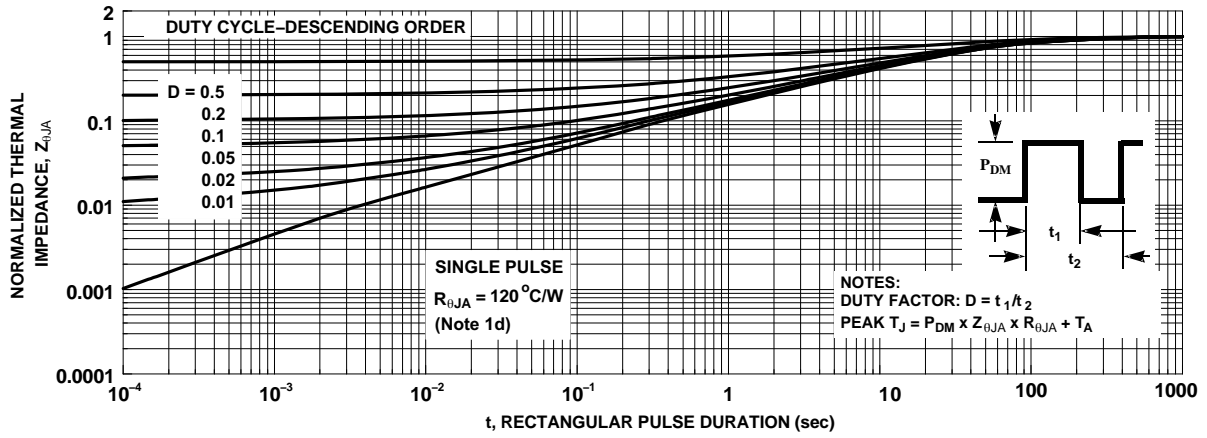

Figure 26. Junction-to-Ambient Transient Thermal Response Curve

FDMS3660S

TYPICAL CHARACTERISTICS (continued)

SyncFET Schottky Body Diode Characteristics

ON Semiconductor's SyncFET process embeds a Schottky diode in parallel with PowerTrench MOSFET. This diode exhibits similar characteristics to a discrete external Schottky diode in parallel with a MOSFET.

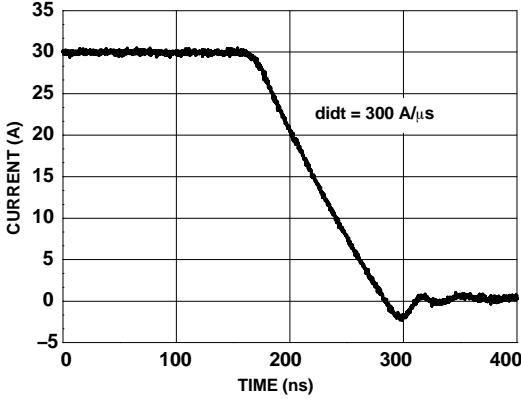

Figure 27. FDMS3660S SyncFET Body Diode Reverse Recovery Characteristic

Figure 27 shows the reverse recovery characteristic of the FDMS001N025DSD.

Schottky barrier diodes exhibit significant leakage at high temperature and high reverse voltage. This will increase the power in the device.

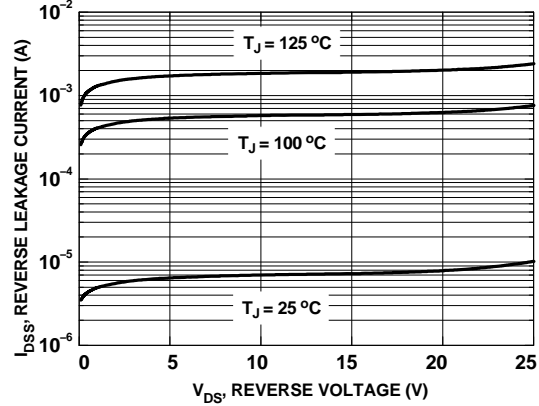

Figure 28. SyncFET Body Diode Reverse Leakage vs. Drain-Source Voltage

Application Information

Switch Node Ringing Suppression

ON Semiconductor's Power Stage products incorporate a proprietary design that minimizes the peak overshoot, ringing voltage on the switch node (PHASE) without the need of any external snubbing components in a buck

converter. As shown in the Figure 29, the Power Stage solution rings significantly less than competitor solutions under the same set of test conditions.

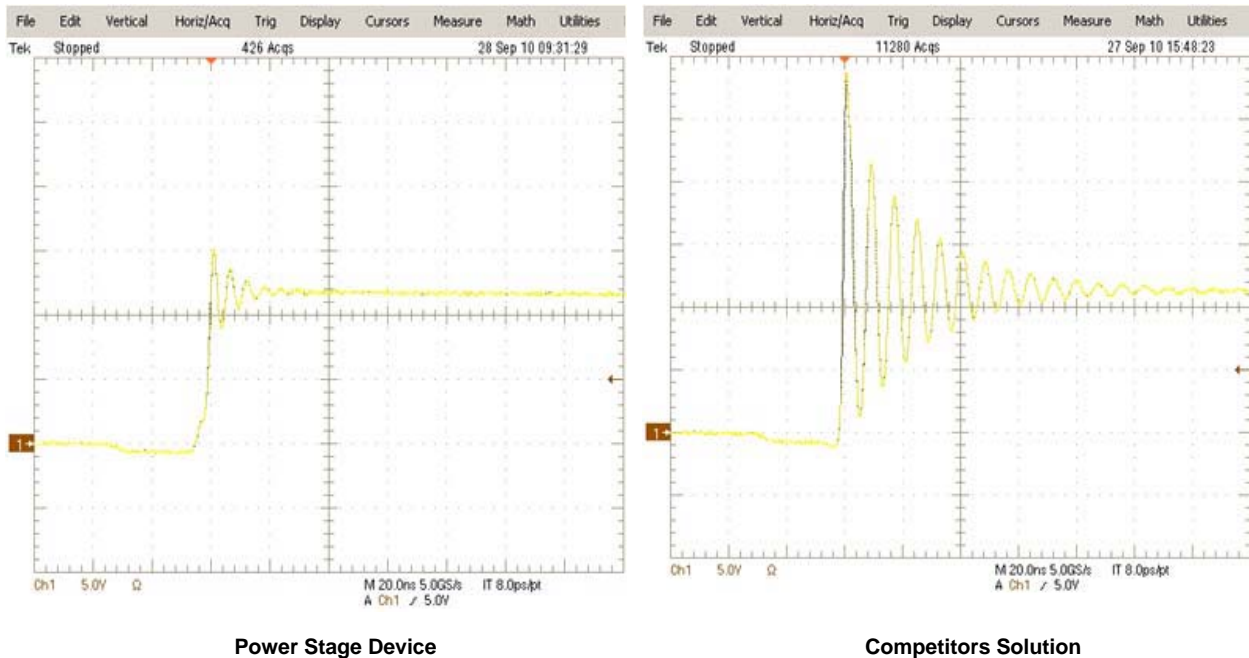

Power Stage Device

Competitors Solution

Figure 29. Power Stage Phase Node Rising Edge, High Side Turn On

FDMS3660S

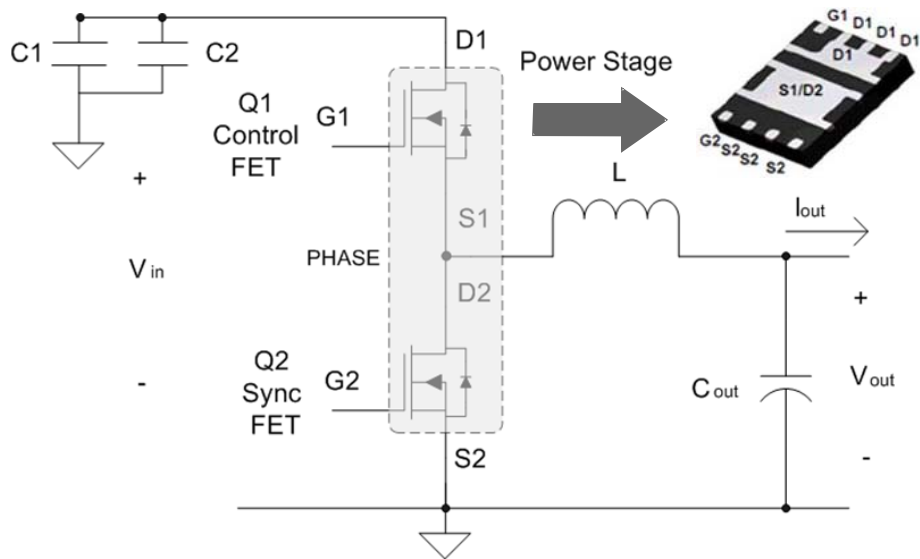

Figure 30. Shows the Power Stage in a Buck Converter Topology

Recommended PCB Layout Guidelines

As a PCB designer, it is necessary to address critical issues in layout to minimize losses and optimize the performance of the power train. Power Stage is a high power density solution and all high current flow paths, such as VIN (D1),

PHASE (S1/D2) and GND (S2), should be short and wide for better and stable current flow, heat radiation and system performance. A recommended layout procedure is discussed below to maximize the electrical and thermal performance of the part.

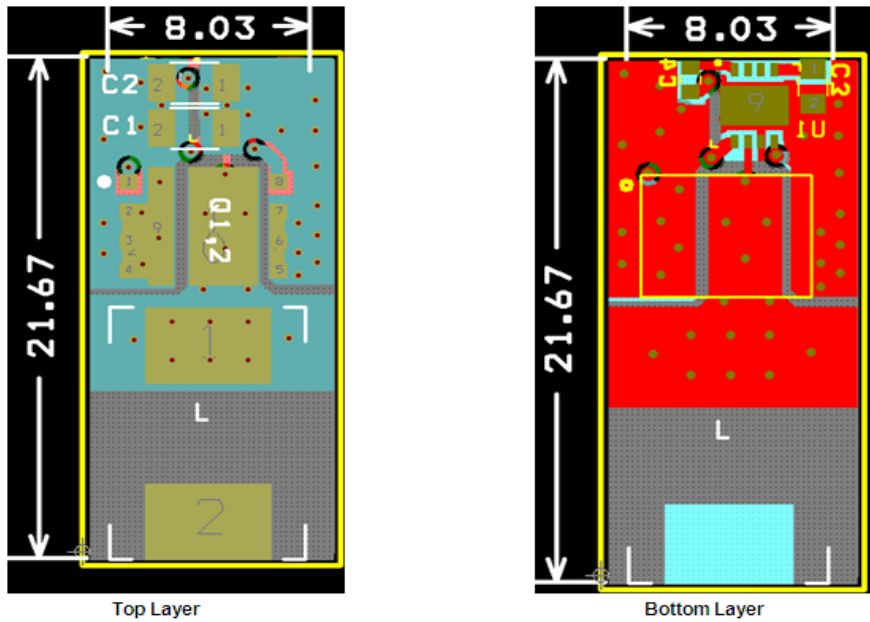

Figure 31. Recommended PCB Layout

Following is a guideline, not a requirement which the PCB designer should consider:

1. Input ceramic bypass capacitors C1 and C2 must be placed close to the D1 and S2 pins of Power Stage to help reduce parasitic inductance and high frequency conduction loss induced by switching operation. C1 and C2 show the bypass capacitors placed close to the part between D1 and S2. Input capacitors should be connected in parallel close to the part. Multiple input caps can be connected depending upon the application.
2. The PHASE copper trace serves two purposes; In addition to being the current path from the Power Stage package to the output inductor (L), it also serves as heat sink for the lower FET in the Power Stage package. The trace should be short and wide enough to present a low resistance path for the high current flow between the Power Stage and the inductor. This is done to minimize conduction losses and limit temperature rise. Please note that the PHASE node is a high voltage and high frequency switching node with high noise potential. Care should be taken to minimize coupling to adjacent traces. The reference layout in Figure 31 shows a good balance between the thermal and electrical performance of Power Stage.
3. Output inductor location should be as close as possible to the Power Stage device for lower power loss due to copper trace resistance. A shorter and wider PHASE trace to the inductor reduces the conduction loss. Preferably the Power Stage should be directly in line (as shown in Figure 31) with the inductor for space savings and compactness.
4. The PowerTrench Technology MOSFETs used in the Power Stage are effective at minimizing phase node ringing. It allows the part to operate well within the breakdown voltage limits. This eliminates the need to have an external snubber circuit in most cases. If the designer chooses to use an RC snubber, it should be placed close to the part between the PHASE pad and S2 pins to dampen the high-frequency ringing.
5. The driver IC should be placed close to the Power Stage part with the shortest possible paths for the High Side gate and Low Side gates through a wide trace connection. This eliminates the effect of parasitic inductance and resistance between the driver and the MOSFET and turns the devices on and off as efficiently as possible. At higher-frequency operation this impedance can limit the gate current trying to charge the MOSFET input capacitance. This will result in slower rise and fall times and additional switching losses. Power Stage has both the gate pins on the same side of the package which allows for back mounting of the driver IC to the board. This provides a very compact path for the drive signals and improves efficiency of the part.
6. S2 pins should be connected to the GND plane with multiple vias for a low impedance grounding. Poor grounding can create a noise transient offset voltage level between S2 and driver ground. This could lead to faulty operation of the gate driver and MOSFET.
7. Use multiple vias on each copper area to interconnect top, inner and bottom layers to help smooth current flow and heat conduction. Vias should be relatively large, around 8 mils to 10 mils, and of reasonable inductance. Critical high frequency components such as ceramic bypass caps should be located close to the part and on the same side of the PCB. If not feasible, they should be connected from the backside via a network of low inductance vias.

MECHANICAL CASE OUTLINE

PACKAGE DIMENSIONS

ON Semiconductor®

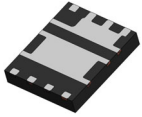

PQFN8 5X6, 1.27P (SAWN TYPE)

CASE 483AJ
ISSUE A

DATE 08 FEB 2021

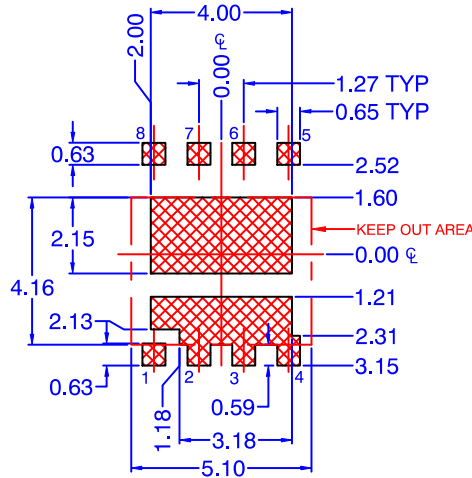
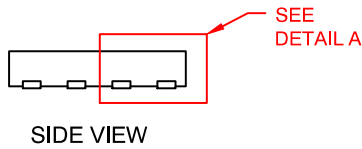
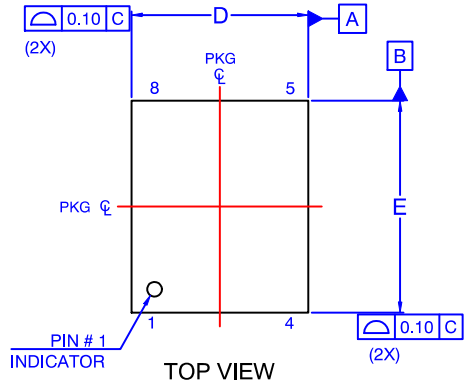

LAND PATTERN RECOMMENDATION FOR SAWN / PUNCHED TYPE

*FOR ADDITIONAL INFORMATION ON OUR PB-FREE STRATEGY AND SOLDERING DETAILS, PLEASE DOWNLOAD THE ON SEMICONDUCTOR SOLDERING AND MOUNTING TECHNIQUES REFERENCE MANUAL, SOLDERRM/D.

DIM	MILLIMETERS		
	MIN.	NOM.	MAX.
A	0.90	1.00	1.10
A1	0.00	-	0.05
b	0.31	0.51	0.61
c	0.10	0.20	0.30
D	4.90	5.00	5.10
D2	2.80	2.90	3.16
D3	3.70	3.80	4.08
E	5.90	6.00	6.25
E2	2.05	2.15	2.25
E3	1.12	1.22	1.34
E4	0.25	0.35	0.45
e	1.27 BSC		
e1	3.81 BSC		
e/2	0.635 BSC		
e3	1.43 BSC		
e4	1.38 BSC		
k	0.61	0.66	0.71
k1	0.82	0.92	1.02
L	0.38	0.48	0.65
L1	0.48	0.58	0.68
z	0.34 REF		

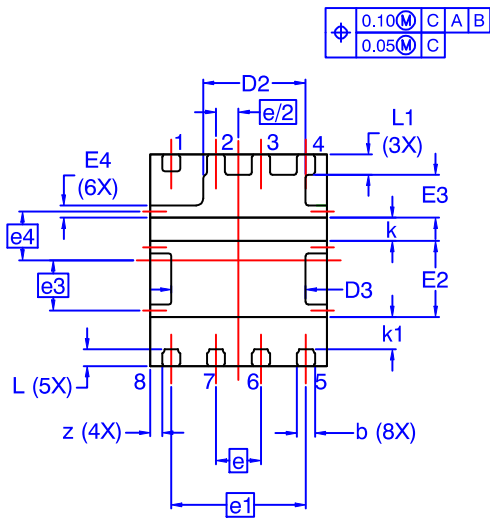

BOTTOM VIEW OPTION - A (SAWN TYPE)

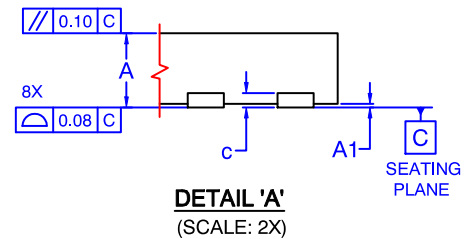

DOCUMENT NUMBER:	98AON13659G	Electronic versions are uncontrolled except when accessed directly from the Document Repository. Printed versions are uncontrolled except when stamped "CONTROLLED COPY" in red.
DESCRIPTION:	PQFN8 5X6, 1.27P	PAGE 1 OF 2

ON Semiconductor and ON are trademarks of Semiconductor Components Industries, LLC dba ON Semiconductor or its subsidiaries in the United States and/or other countries. ON Semiconductor reserves the right to make changes without further notice to any products herein. ON Semiconductor makes no warranty, representation or guarantee regarding the suitability of its products for any particular purpose, nor does ON Semiconductor assume any liability arising out of the application or use of any product or circuit, and specifically disclaims any and all liability, including without limitation special, consequential or incidental damages. ON Semiconductor does not convey any license under its patent rights nor the rights of others.

MECHANICAL CASE OUTLINE

PACKAGE DIMENSIONS

ON Semiconductor®



PQFN8 5X6, 1.27P (PUNCHED TYPE)

CASE 483AJ
ISSUE A

DATE 08 FEB 2021

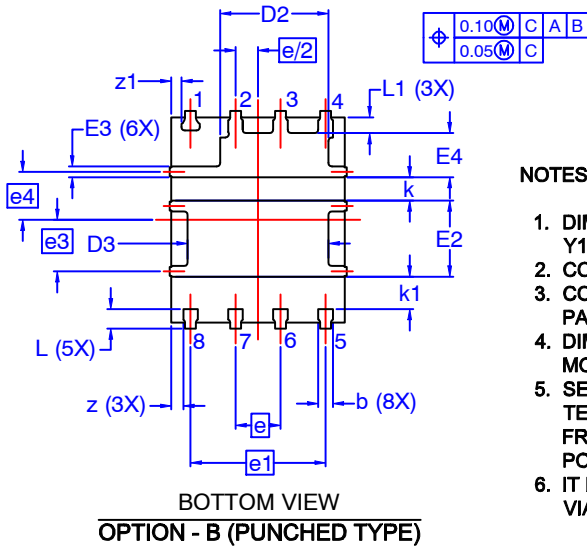
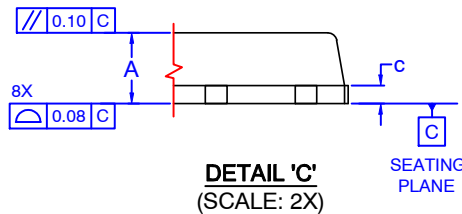
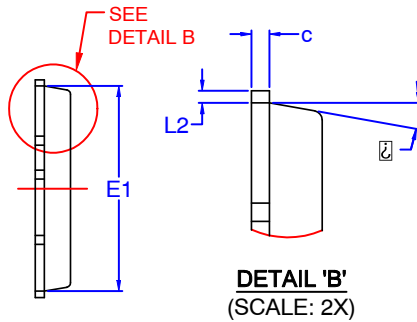
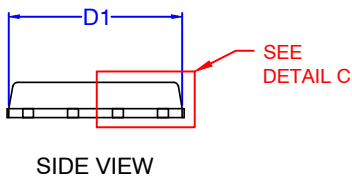
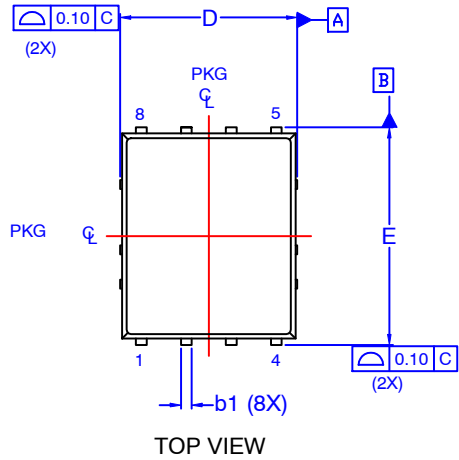

DIM	MILLIMETERS		
	MIN.	NOM.	MAX.
A	0.90	1.00	1.10
b	0.31	0.51	0.61
b1	0.21	0.31	0.41
c	0.15	0.25	0.35
D	4.90	5.00	5.10
D1	4.80	4.90	5.00
D2	2.80	3.06	3.16
D3	3.70	3.98	4.08
E	5.90	6.00	6.25
E1	5.70	5.80	5.90
E2	2.05	2.15	2.25
E3	0.25	0.33	0.45
E4	1.12	1.24	1.34
e	1.27 BSC		
e1	3.81 BSC		
e/2	0.635 BSC		
e3	1.45 BSC		
e4	1.36 BSC		
k	0.61	0.66	0.71
k1	0.82	0.92	1.02
L	0.38	0.55	0.65
L1	0.35	0.45	0.55
L2	0.08	0.18	0.28
z	0.34 REF		
z1	0.28 REF		
θ	0°	-	10°

NOTES:

1. DIMENSIONING AND TOLERANCING PER ASME Y14.5M, 2009.
2. CONTROLLING DIMENSION: MILLIMETERS
3. COPLANARITY APPLIES TO THE EXPOSED PADS AS WELL AS THE TERMINALS.
4. DIMENSIONS D1 AND E1 DO NOT INCLUDE MOLD FLASH, PROTRUSIONS, OR GATE BURRS.
5. SEATING PLANE IS DEFINED BY THE TERMINALS. "A1" IS DEFINED AS THE DISTANCE FROM THE SEATING PLANE TO THE LOWEST POINT ON THE PACKAGE BODY.
6. IT IS RECOMMENDED TO HAVE NO TRACES OR VIAS WITHIN THE KEEP OUT AREA.

DOCUMENT NUMBER:	98AON13659G	Electronic versions are uncontrolled except when accessed directly from the Document Repository. Printed versions are uncontrolled except when stamped "CONTROLLED COPY" in red.
DESCRIPTION:	PQFN8 5X6, 1.27P	PAGE 2 OF 2

ON Semiconductor and are trademarks of Semiconductor Components Industries, LLC dba ON Semiconductor or its subsidiaries in the United States and/or other countries. ON Semiconductor reserves the right to make changes without further notice to any products herein. ON Semiconductor makes no warranty, representation or guarantee regarding the suitability of its products for any particular purpose, nor does ON Semiconductor assume any liability arising out of the application or use of any product or circuit, and specifically disclaims any and all liability, including without limitation special, consequential or incidental damages. ON Semiconductor does not convey any license under its patent rights nor the rights of others.

onsemi, **Onsemi**, and other names, marks, and brands are registered and/or common law trademarks of Semiconductor Components Industries, LLC dba "**onsemi**" or its affiliates and/or subsidiaries in the United States and/or other countries. **onsemi** owns the rights to a number of patents, trademarks, copyrights, trade secrets, and other intellectual property. A listing of **onsemi**'s product/patent coverage may be accessed at www.onsemi.com/site/pdf/Patent-Marking.pdf. **onsemi** reserves the right to make changes at any time to any products or information herein, without notice. The information herein is provided "as-is" and **onsemi** makes no warranty, representation or guarantee regarding the accuracy of the information, product features, availability, functionality, or suitability of its products for any particular purpose, nor does **onsemi** assume any liability arising out of the application or use of any product or circuit, and specifically disclaims any and all liability, including without limitation special, consequential or incidental damages. Buyer is responsible for its products and applications using **onsemi** products, including compliance with all laws, regulations and safety requirements or standards, regardless of any support or applications information provided by **onsemi**. "Typical" parameters which may be provided in **onsemi** data sheets and/or specifications can and do vary in different applications and actual performance may vary over time. All operating parameters, including "Typicals" must be validated for each customer application by customer's technical experts. **onsemi** does not convey any license under any of its intellectual property rights nor the rights of others. **onsemi** products are not designed, intended, or authorized for use as a critical component in life support systems or any FDA Class 3 medical devices or medical devices with a same or similar classification in a foreign jurisdiction or any devices intended for implantation in the human body. Should Buyer purchase or use **onsemi** products for any such unintended or unauthorized application, Buyer shall indemnify and hold **onsemi** and its officers, employees, subsidiaries, affiliates, and distributors harmless against all claims, costs, damages, and expenses, and reasonable attorney fees arising out of, directly or indirectly, any claim of personal injury or death associated with such unintended or unauthorized use, even if such claim alleges that **onsemi** was negligent regarding the design or manufacture of the part. **onsemi** is an Equal Opportunity/Affirmative Action Employer. This literature is subject to all applicable copyright laws and is not for resale in any manner.

ADDITIONAL INFORMATION

TECHNICAL PUBLICATIONS:

Technical Library: www.onsemi.com/design/resources/technical-documentation
onsemi Website: www.onsemi.com

ONLINE SUPPORT: www.onsemi.com/support

For additional information, please contact your local Sales Representative at www.onsemi.com/support/sales