

MOSFET – N-Channel, SUPERFET II, FRFET

600 V, 37 A, 104 mΩ

FCH104N60F-F085

Description

SUPERFET[®] II MOSFET is ON Semiconductor's brand-new high voltage super-junction (SJ) MOSFET family that is utilizing charge balance technology for outstanding low on-resistance and lower gate charge performance. This technology is tailored to minimize conduction loss, provide superior switching performance, dv/dt rate and higher avalanche energy. Consequently SUPERFET II is very well suited for the Soft switching and Hard Switching topologies like High Voltage Full Bridge and Half Bridge DC-DC, Interleaved Boost PFC, Boost PFC for HEV-EV automotive.

SUPERFET II FRFET[®] MOSFET's optimized body diode reverse recovery performance can remove additional component and improve system reliability.

Features

- Typical $R_{DS(on)}$ = 91 mΩ at $V_{GS} = 10$ V, $I_D = 18.5$ A
- Typical $Q_{g(tot)}$ = 109 nC at $V_{GS} = 10$ V, $I_D = 18.5$ A
- UIS Capability
- Qualified to AEC Q101 and PPAP Capable
- This Device is Pb-Free and is RoHS Compliant

Applications

- Automotive On Board Charger
- Automotive DC/DC Converter for HEV



ON Semiconductor[®]

www.onsemi.com

V_{DSS}	$R_{DS(on)}$ MAX	I_D MAX
600 V	104 mΩ	37 A

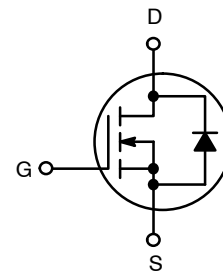

N-Channel MOSFET

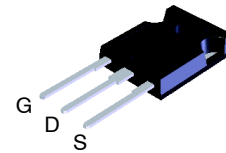

TO-247
CASE 340CK

MARKING DIAGRAM

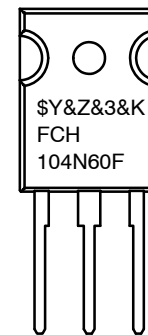

\$Y = ON Semiconductor Logo
 &Z = Assembly Plant Code
 &3 = Data Code (Year & Week)
 &K = Lot Code
 FCH104N60F = Specific Device Code

ORDERING INFORMATION

See detailed ordering and shipping information on page 2 of this data sheet.

FCH104N60F-F085

MAXIMUM RATINGS (T_C = 25°C, unless otherwise specified)

Symbol	Parameter	Ratings	Unit
V _{DSS}	Drain to Source Voltage	600	V
V _{GS}	Gate to Source Voltage	±20	V
I _D	Drain Current – Continuous (V _{GS} = 10) (Note 1)	T _C = 25°C T _C = 100°C	A
	Pulsed Drain Current	See Fig. 4	
E _{AS}	Single Pulsed Avalanche Rating (Note 2)	809	mJ
dv/dt	MOSFET dv/dt	100	V/ns
	Peak Diode Recovery dv/dt (Note 3)	50	
P _D	Power Dissipation	357	W
	Derate Above 25°C	2.85	W/°C
T _J , T _{STG}	Operating and Storage Temperature	-55 to +150	°C

Stresses exceeding those listed in the Maximum Ratings table may damage the device. If any of these limits are exceeded, device functionality should not be assumed, damage may occur and reliability may be affected.

1. Current is limited by bondwire configuration.
2. Starting T_J = 25°C, L = 35 mH, I_{AS} = 6.8 A, V_{DD} = 100 V during inductor charging and V_{DD} = 0 V during time in avalanche.
3. I_{SD} ≤ 18.5 A, di/dt ≤ 200 A/μs, V_{DD} ≤ 380 V, starting T_J = 25°C.
4. R_{θJA} is the sum of the junction-to-case and case-to-ambient thermal resistance, where the case thermal reference is defined as the solder mounting surface of the drain pins. R_{θJC} is guaranteed by design, while R_{θJA} is determined by the board design. The maximum rating presented here is based on mounting on a 1 in² pad of 2oz copper.

THERMAL CHARACTERISTICS

Symbol	Parameter	Ratings	Unit
R _{θJC}	Maximum Thermal Resistance, Junction to Case	0.35	°C/W
R _{θJA}	Maximum Thermal Resistance, Junction to Ambient	40	

PACKAGE MARKING AND ORDERING INFORMATION

Device	Device Marking	Package	Reel Size	Tape Width	Quantity
FCH104N60F-F085	FCH104N60F	TO-247	-	-	30

FCH104N60F-F085

ELECTRICAL CHARACTERISTICS (T_C = 25°C unless otherwise noted)

Symbol	Parameter	Test Conditions	Min	Typ	Max	Unit
--------	-----------	-----------------	-----	-----	-----	------

OFF CHARACTERISTICS

BV _{DSS}	Drain to Source Breakdown Voltage	V _{GS} = 0 V, I _D = 250 μA	600	-	-	V
I _{DSS}	Drain to Source Leakage Current	V _{DS} = 600 V, V _{GS} = 0 V, T _J = 25°C	-	-	10	μA
		V _{DS} = 600 V, V _{GS} = 0 V, T _J = 150°C (Note 5)	-	-	1	mA
I _{GSS}	Gate to Source Leakage Current	V _{GS} = ±20 V	-	-	±100	nA

ON CHARACTERISTICS

V _{GS(th)}	Gate to Source Threshold Voltage	V _{GS} = V _{DS} , I _D = 250 μA	3	4	5	V
r _{DS(on)}	Drain to Source On Resistance	V _{GS} = 10 V, I _D = 18.5 A, T _J = 25°C	-	91	104	mΩ
		V _{GS} = 10 V, I _D = 18.5 A, T _J = 150°C (Note 5)	-	217	275	mΩ

DYNAMIC CHARACTERISTICS

C _{iss}	Input Capacitance	V _{DS} = 100 V, V _{GS} = 0 V, f = 1 MHz	-	4302	-	pF
C _{oss}	Output Capacitance		-	134	-	pF
C _{rss}	Reverse Transfer Capacitance		-	1.7	-	pF
R _g	Gate Resistance	f = 1 MHz	-	0.49	-	Ω
Q _{g(TOT)}	Total Gate Charge	V _{DD} = 380 V, I _D = 18.5 A, V _{GS} = 10 V	-	109	139	nC
Q _{g(th)}	Threshold Gate Charge		-	8	11	nC
Q _{gs}	Gate to Source Gate Charge		-	23	-	nC
Q _{gd}	Gate to Drain "Miller" Charge		-	46	-	nC

SWITCHING CHARACTERISTICS

t _{on}	Turn-On Time	V _{DD} = 380 V, I _D = 18.5 A, V _{GS} = 10 V, R _G = 4.7 Ω	-	58	78	ns
t _{d(on)}	Turn-On Delay Time		-	35	-	ns
t _r	Rise Time		-	23	-	ns
t _{d(off)}	Turn-Off Delay Time		-	94	-	ns
t _f	Fall Time		-	5	-	ns
t _{off}	Turn-Off Time		-	98	131	ns

DRAIN-SOURCE DIODE CHARACTERISTICS

V _{SD}	Source to Drain Diode Voltage	I _{SD} = 18.5 A, V _{GS} = 0 V	-	-	1.2	V
T _{rr}	Reverse Recovery Time	I _F = 18.5 A, dI _{SD} /dt = 100 A/μs V _{DD} = 480 V	-	162	-	ns
Q _{rr}	Reverse Recovery Charge		-	1223	-	nC

Product parametric performance is indicated in the Electrical Characteristics for the listed test conditions, unless otherwise noted. Product performance may not be indicated by the Electrical Characteristics if operated under different conditions.

5. The maximum value is specified by design at T_J = 150°C. Product is not tested to this condition in production.

FCH104N60F-F085

TYPICAL CHARACTERISTICS

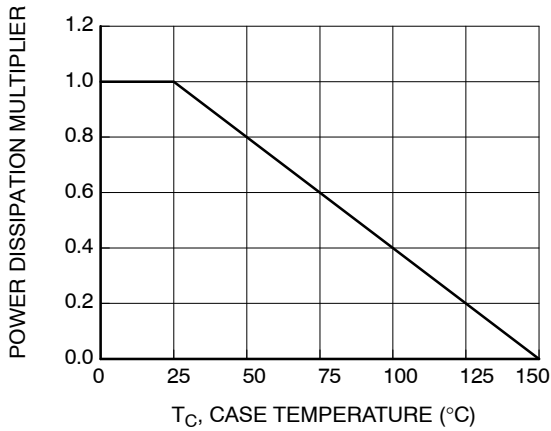

Figure 1. Normalized Power Dissipation vs. Case Temperature

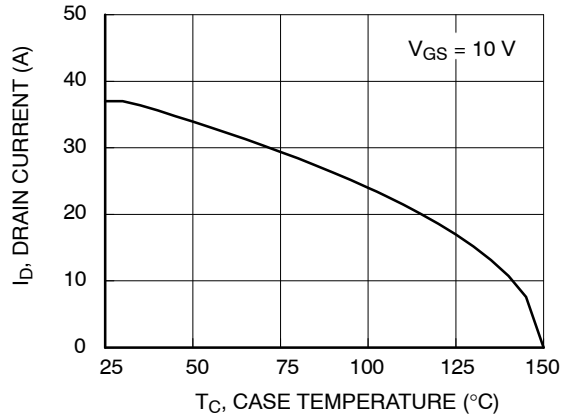

Figure 2. Maximum Continuous Drain Current vs. Case Temperature

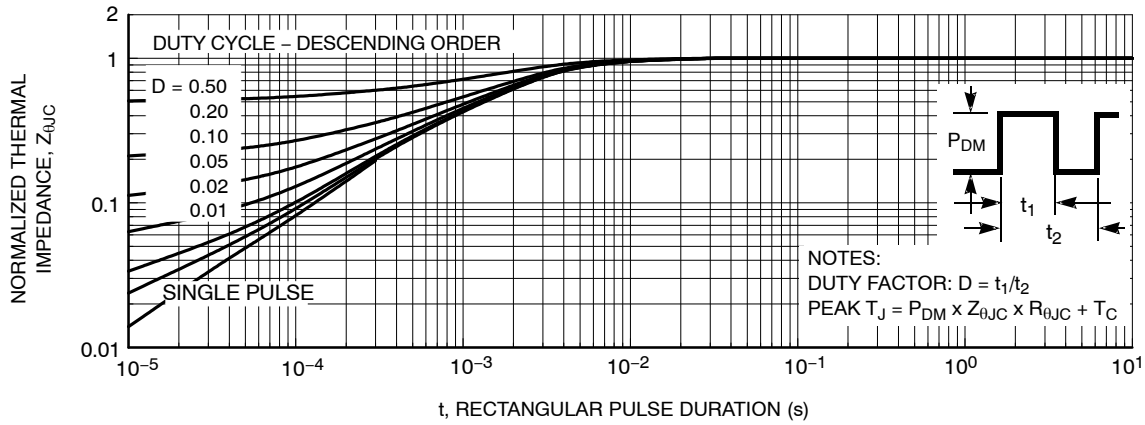

Figure 3. Normalized Maximum Transient Thermal Impedance

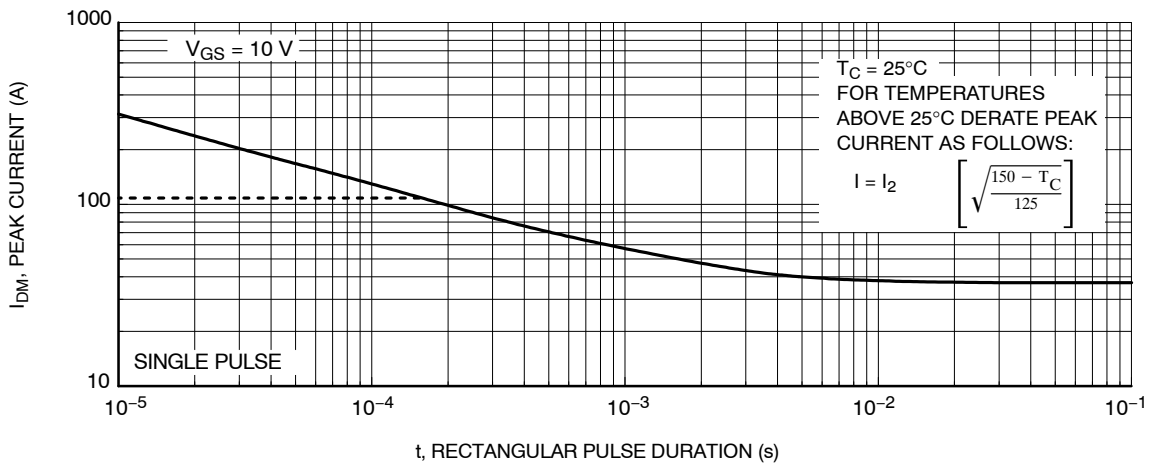

Figure 4. Peak Current Capability

TYPICAL CHARACTERISTICS (continued)

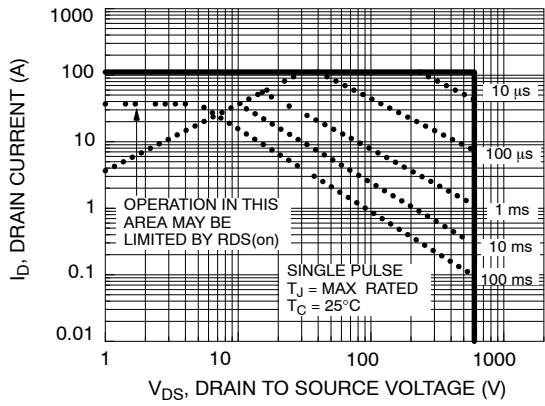

Figure 5. Forward Bias Safe Operating Area

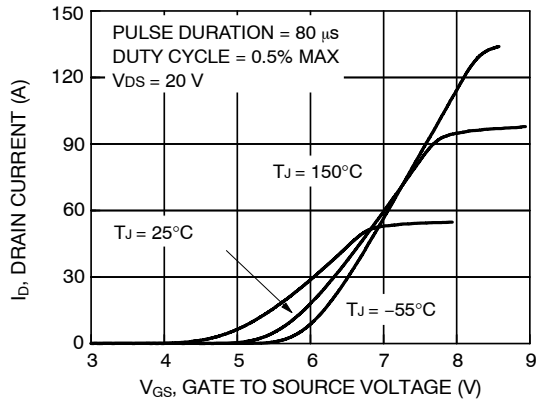

Figure 6. Transfer Characteristics

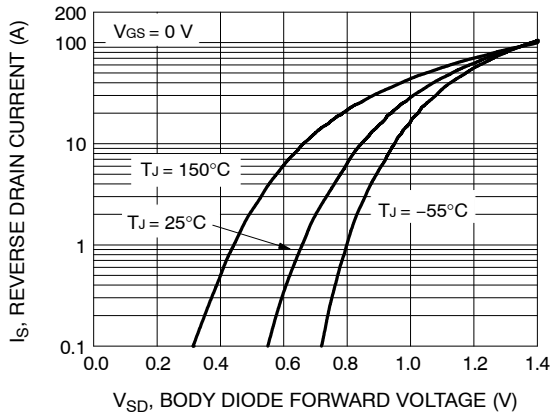

Figure 7. Forward Diode Characteristics

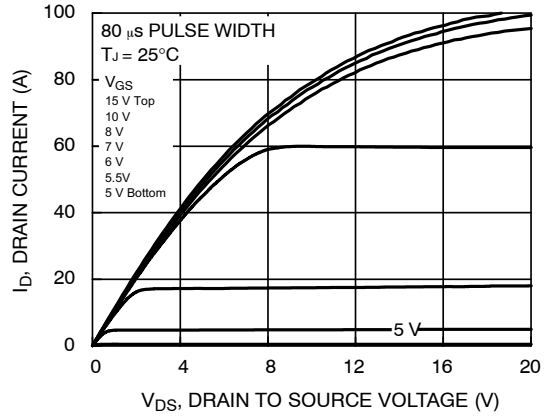

Figure 8. Forward Diode Characteristics

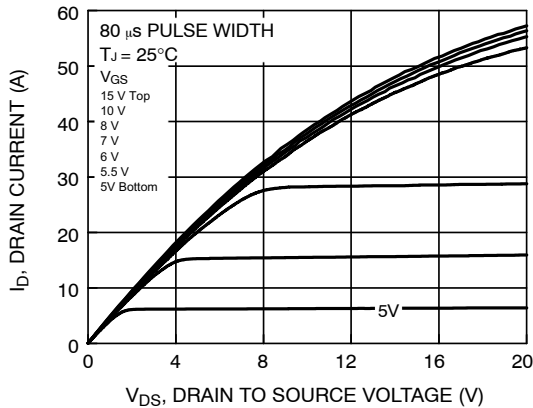

Figure 9. Saturation Characteristics

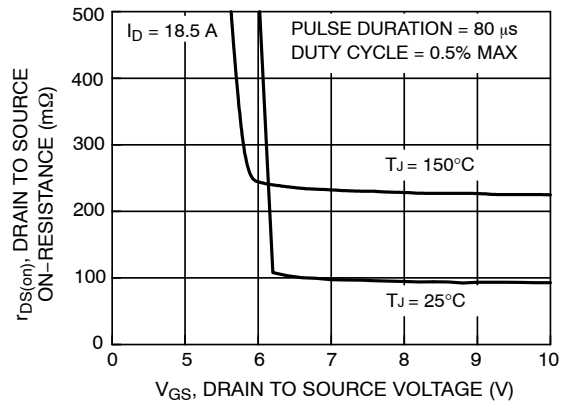

Figure 10. $R_{DS(on)}$ vs. Gate Voltage

TYPICAL CHARACTERISTICS (continued)

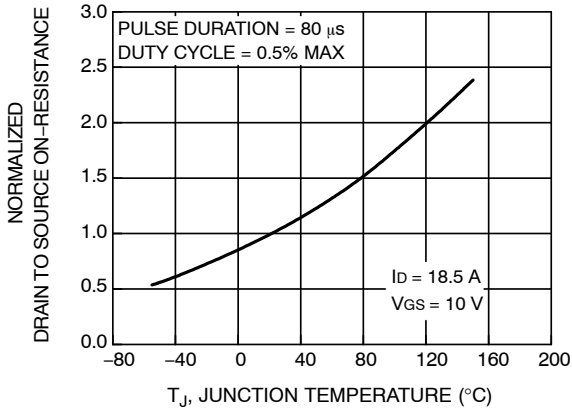

Figure 11. Normalized $R_{DS(on)}$ vs. Junction Temperature

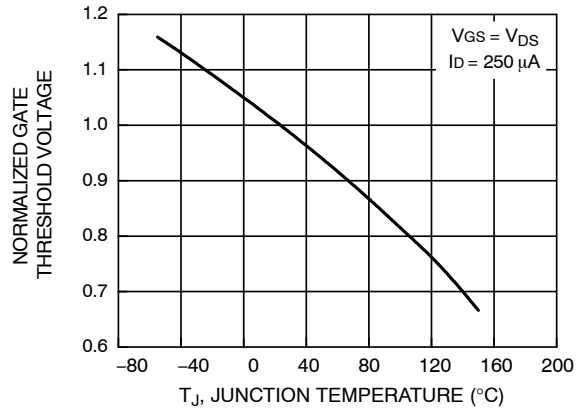

Figure 12. Normalized Gate Threshold Voltage vs. Temperature

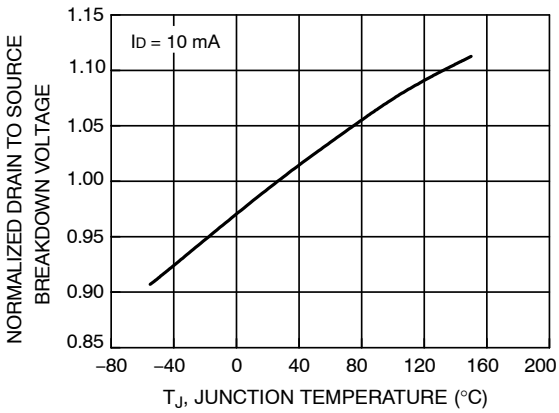

Figure 13. Normalized Drain to Source Breakdown Voltage vs. Junction Temperature

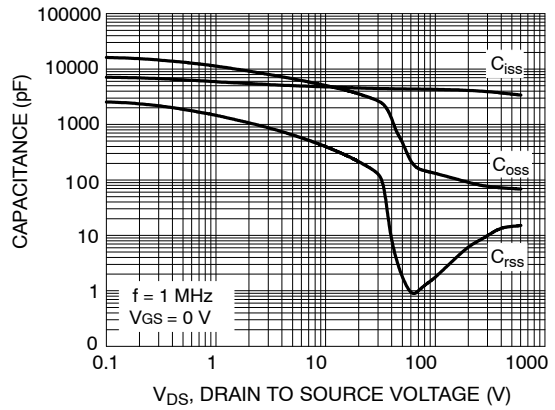

Figure 14. Capacitance vs. Drain to Source Voltage

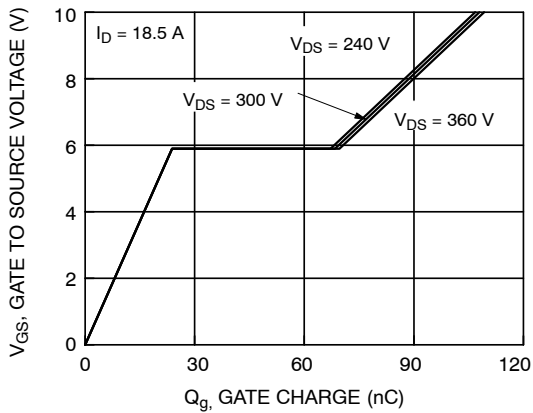

Figure 15. Gate Charge vs. Gate to Source Voltage

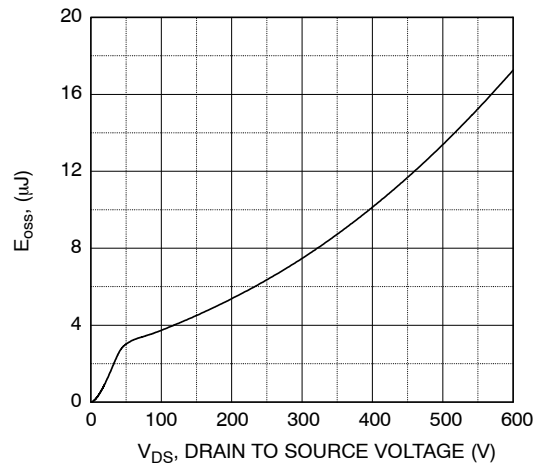

Figure 16. E_{oss} vs. Drain to Source Voltage



Figure 17. Gate Charge Test Circuit & Waveform



Figure 18. Resistive Switching Test Circuit & Waveforms

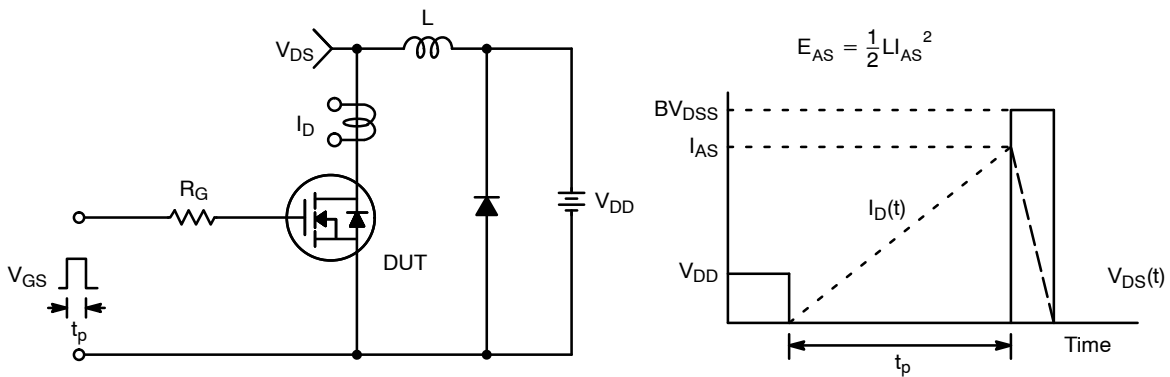

Figure 19. Unclamped Inductive Switching Test Circuit & Waveforms

FCH104N60F-F085

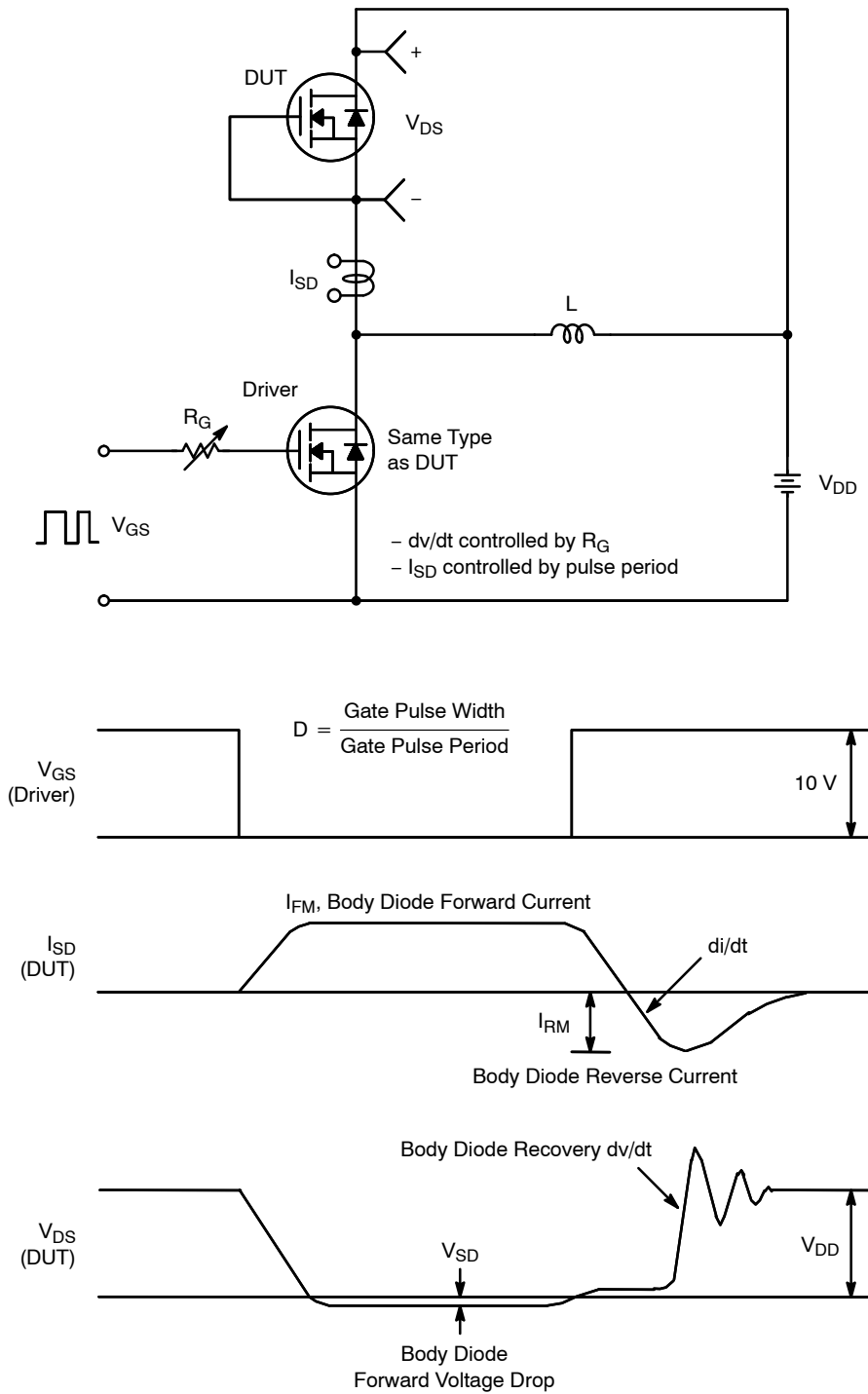

Figure 20. Peak Diode Recovery dv/dt Test Circuit & Waveforms

SUPERFET is a registered trademark of Semiconductor Components Industries, LLC (SCILLC) or its subsidiaries in the United States and/or other countries.
 FRFET is a registered trademark of Semiconductor Components Industries, LLC (SCILLC) or its subsidiaries in the United States and/or other countries.



TO-247-3LD SHORT LEAD
CASE 340CK
ISSUE A

DATE 31 JAN 2019



NOTES: UNLESS OTHERWISE SPECIFIED.

- A. DIMENSIONS ARE EXCLUSIVE OF BURRS, MOLD FLASH, AND TIE BAR EXTRUSIONS.
- B. ALL DIMENSIONS ARE IN MILLIMETERS.
- C. DRAWING CONFORMS TO ASME Y14.5 - 2009.
- D. DIMENSION A1 TO BE MEASURED IN THE REGION DEFINED BY L1.
- E. LEAD FINISH IS UNCONTROLLED IN THE REGION DEFINED BY L1.

GENERIC MARKING DIAGRAM*



- XXXX = Specific Device Code
- A = Assembly Location
- Y = Year
- WW = Work Week
- ZZ = Assembly Lot Code

*This information is generic. Please refer to device data sheet for actual part marking. Pb-Free indicator, "G" or microdot "•", may or may not be present. Some products may not follow the Generic Marking.

DIM	MILLIMETERS		
	MIN	NOM	MAX
A	4.58	4.70	4.82
A1	2.20	2.40	2.60
A2	1.40	1.50	1.60
b	1.17	1.26	1.35
b2	1.53	1.65	1.77
b4	2.42	2.54	2.66
c	0.51	0.61	0.71
D	20.32	20.57	20.82
D1	13.08	~	~
D2	0.51	0.93	1.35
E	15.37	15.62	15.87
E1	12.81	~	~
E2	4.96	5.08	5.20
e	~	5.56	~
L	15.75	16.00	16.25
L1	3.69	3.81	3.93
ØP	3.51	3.58	3.65
ØP1	6.60	6.80	7.00
Q	5.34	5.46	5.58
S	5.34	5.46	5.58

DOCUMENT NUMBER:	98AON13851G	Electronic versions are uncontrolled except when accessed directly from the Document Repository. Printed versions are uncontrolled except when stamped "CONTROLLED COPY" in red.
DESCRIPTION:	TO-247-3LD SHORT LEAD	PAGE 1 OF 1

ON Semiconductor and are trademarks of Semiconductor Components Industries, LLC dba ON Semiconductor or its subsidiaries in the United States and/or other countries. ON Semiconductor reserves the right to make changes without further notice to any products herein. ON Semiconductor makes no warranty, representation or guarantee regarding the suitability of its products for any particular purpose, nor does ON Semiconductor assume any liability arising out of the application or use of any product or circuit, and specifically disclaims any and all liability, including without limitation special, consequential or incidental damages. ON Semiconductor does not convey any license under its patent rights nor the rights of others.

onsemi, **Onsemi**, and other names, marks, and brands are registered and/or common law trademarks of Semiconductor Components Industries, LLC dba "**onsemi**" or its affiliates and/or subsidiaries in the United States and/or other countries. **onsemi** owns the rights to a number of patents, trademarks, copyrights, trade secrets, and other intellectual property. A listing of **onsemi**'s product/patent coverage may be accessed at www.onsemi.com/site/pdf/Patent-Marking.pdf. **onsemi** reserves the right to make changes at any time to any products or information herein, without notice. The information herein is provided "as-is" and **onsemi** makes no warranty, representation or guarantee regarding the accuracy of the information, product features, availability, functionality, or suitability of its products for any particular purpose, nor does **onsemi** assume any liability arising out of the application or use of any product or circuit, and specifically disclaims any and all liability, including without limitation special, consequential or incidental damages. Buyer is responsible for its products and applications using **onsemi** products, including compliance with all laws, regulations and safety requirements or standards, regardless of any support or applications information provided by **onsemi**. "Typical" parameters which may be provided in **onsemi** data sheets and/or specifications can and do vary in different applications and actual performance may vary over time. All operating parameters, including "Typicals" must be validated for each customer application by customer's technical experts. **onsemi** does not convey any license under any of its intellectual property rights nor the rights of others. **onsemi** products are not designed, intended, or authorized for use as a critical component in life support systems or any FDA Class 3 medical devices or medical devices with a same or similar classification in a foreign jurisdiction or any devices intended for implantation in the human body. Should Buyer purchase or use **onsemi** products for any such unintended or unauthorized application, Buyer shall indemnify and hold **onsemi** and its officers, employees, subsidiaries, affiliates, and distributors harmless against all claims, costs, damages, and expenses, and reasonable attorney fees arising out of, directly or indirectly, any claim of personal injury or death associated with such unintended or unauthorized use, even if such claim alleges that **onsemi** was negligent regarding the design or manufacture of the part. **onsemi** is an Equal Opportunity/Affirmative Action Employer. This literature is subject to all applicable copyright laws and is not for resale in any manner.

ADDITIONAL INFORMATION

TECHNICAL PUBLICATIONS:

Technical Library: www.onsemi.com/design/resources/technical-documentation
onsemi Website: www.onsemi.com

ONLINE SUPPORT: www.onsemi.com/support

For additional information, please contact your local Sales Representative at www.onsemi.com/support/sales