

NCP4305DGEVB

NCP4305 Synchronous Rectification Evaluation Board User's Manual



ON Semiconductor®

www.onsemi.com

Table 1. GENERAL PARAMETERS

SMPS Type	Supply Voltage	Reverse Voltage	Effective Resistance
LLC	5-35 V	40 V	0.9 mΩ

Description

This evaluation board user's manual describes a high efficiency synchronous rectification evaluation board that can easily replace a secondary side rectification diode in an SMPS.

The NCP4305 is used as synchronous rectification controller. The evaluation board has very few external components and illustrates how small and effective such a design can be.

The NCP4305 features a very precise 0 mV turn-off comparator that supports even very low current flowing through the MOSFET even when very low $R_{DS(ON)}$ synchronous MOSFETs is used.

Key Features

- Precise Turn-off Comparator
- Wide Input Voltage Range
- High Operation Frequency
- Strong MOSFET Driver
- High Efficiency
- Adjustable Minimum On and Off Times
- Light Load Detection Feature
- Capable to Operate in Positive and Negative Branch
- Small size

EVAL BOARD USER'S MANUAL

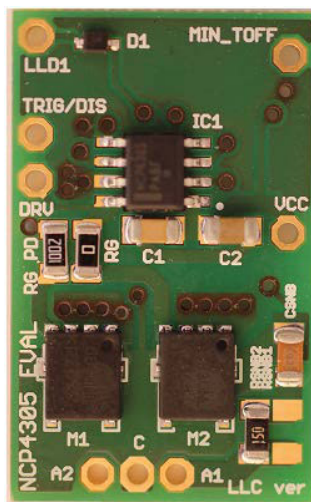

Figure 1. NCP4305 Evaluation Board

NCP4305DGEVB

Connection Diagram

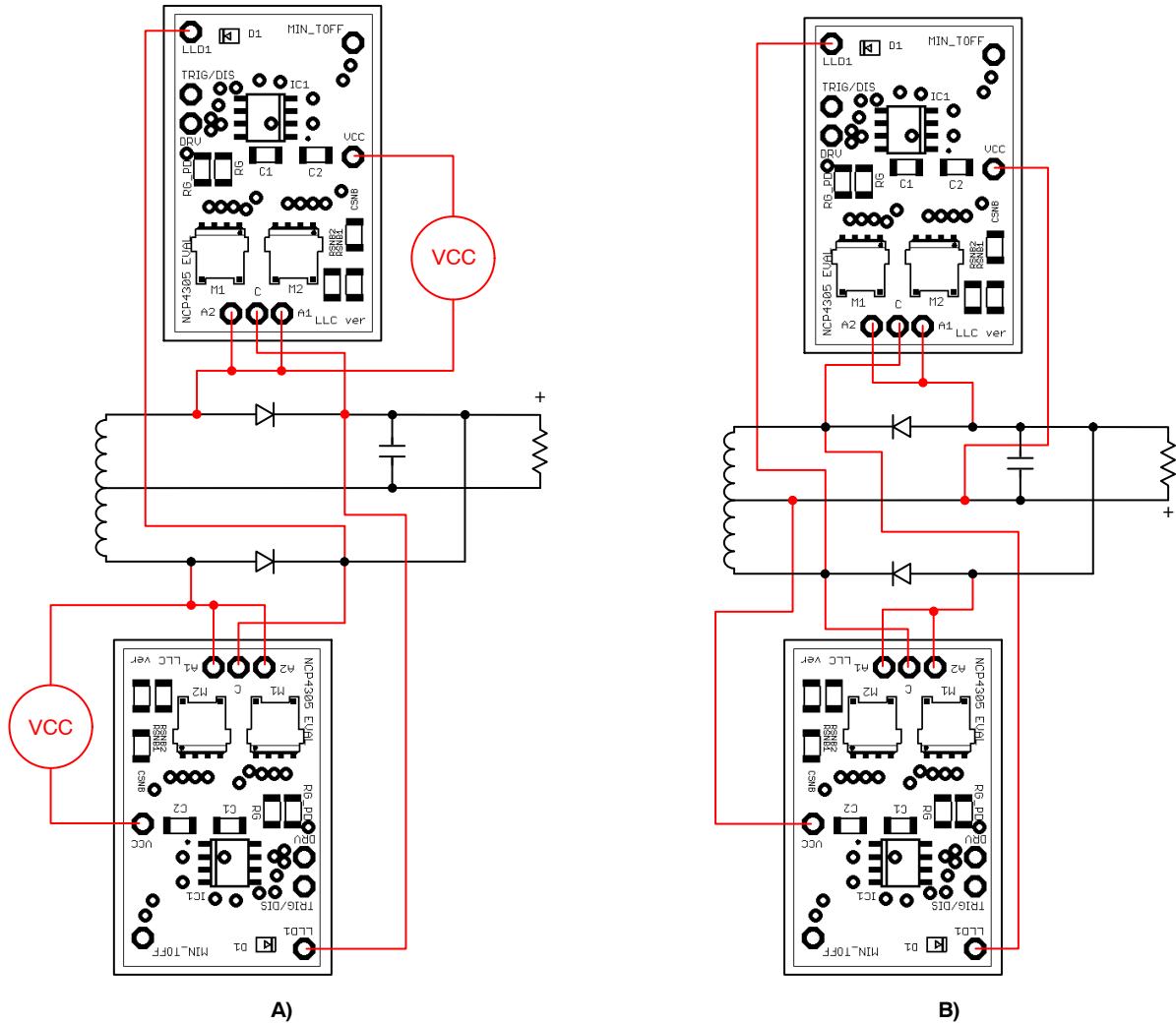

Figure 2. Possible Connections in to Circuit

The evaluation board can be connected in circuit where the rectification diode is in the positive or negative branch. When connection to a positive branch is used, it is necessary to use an external power supply (or auxiliary winding with

rectification) to provide power to the evaluation board. VCC should be referenced to A1 or A2 points. When LLD function is used it is needed to connect LLD1 pin with opposite side rectifier cathode.

Evaluation Board Schematic

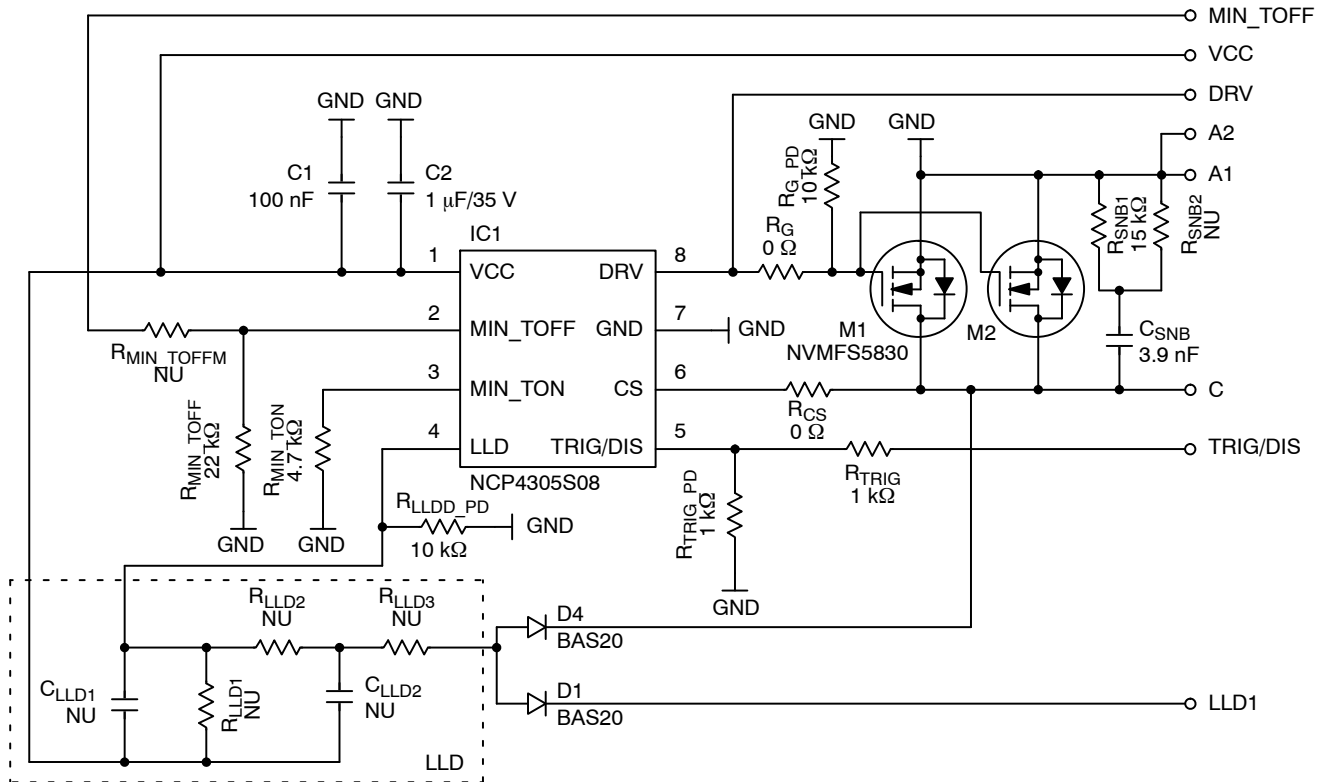

Figure 3. Schematic of the NCP4305

The evaluation board was designed to support a minimal external component count implementation. C1 and C2 are decoupling capacitors. They should be placed as close as possible to the VCC and GND pins. Resistors R_{MIN_TON} and R_{MIN_TOFF} are used to set the protection interval when the synchronous MOSFET is turned on and off. Resistor R_{MIN_TOFFM} is placed there to support a situation when an external circuit provides control for minimum off-time modulation. This is needed only in situations when the minimum off-time cannot be set across the whole range of power supply operation. Resistor R_{TRIG_PD} is only pull down for TRIG pin and R_{TRIG} is only protection resistor. A position for a gate resistor R_G is provided in case there is a need to slow down the MOSFET switching process. The turn-off (and also the turn-on) threshold can be lowered when resistor R_{CS} is used. Components C_{SNB} , R_{SNB1} and R_{SNB2} form a snubber circuit.

LLD circuit consists of C_{LLD1} , C_{LLD2} , R_{LLD1} , R_{LLD2} , R_{LLD3} and D4. Purpose of circuit is to estimate output power. This can be done in two ways. The first is to measure duty cycle of skip burst. LLD circuit time constant is high and it filters and averages duty cycle ratio. This is good for systems which transfer low energy during skip each switch cycle. When duty cycle of skip bursts is low NCP4305 enters disable mode to save energy, when it is higher SR controller

starts to operate and SR transistor gate voltage is modulated according to skip duty cycle. The second option is for system which transfers lot of energy in few first pulses in skip and then transferred energy is minimal. In this case LLD circuit time constant is low and R_{LLD3} resistance is close to 0. LLD pin voltage drops down in first switching pulse in skip mode and NCP4305 wakes up fast and allows using fully open SR transistor. When skip burst ends, LLD voltage goes high and if time between skip bursts is long enough NCP4305 enters disable mode to save energy.

Circuit Layout

The PCB consists of a 2 layer FR4 board with 35 μm copper cladding. All components are surface mount and most of the components that may require adjustment are on the same side and use 1206 values for easy rework. Critical component such as blocking capacitors C1 and C2 have to be placed carefully near the IC. The synchronous driver path to the MOSFETs was done with very low resistance and parasitic inductance to minimize emissions and minimize turn-on and turn-off times. The same is true for the CS pin. For the CS pin, a kelvin contact was done to be able to sense the voltage directly at the drain. Improper connection of the GND and CS connects can impact the turn-off process especially when a very low $R_{DS(on)}$ MOSFETs are used.

NCP4305DGEVB

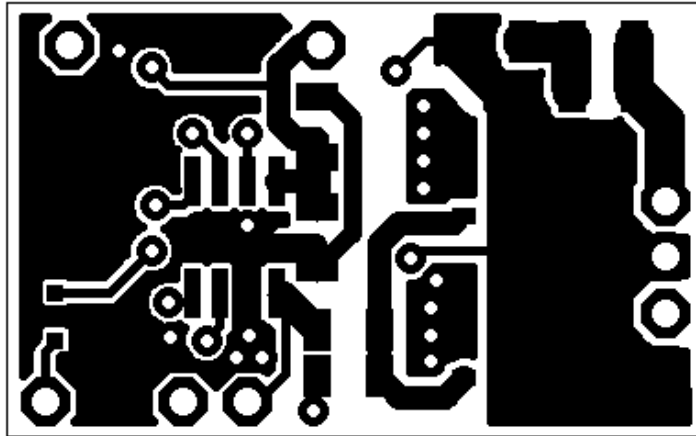

Figure 4. Top Layer

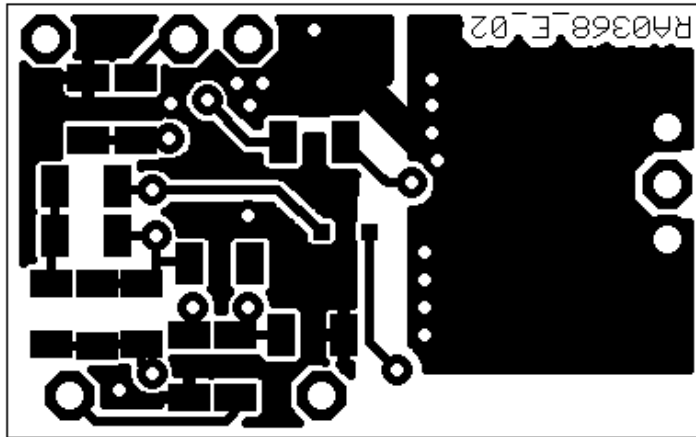

Figure 5. Bottom Layer

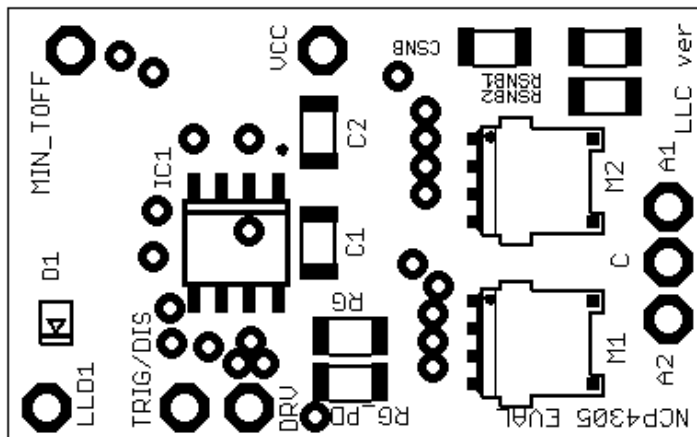

Figure 6. Top Side Components

NCP4305DGEVB

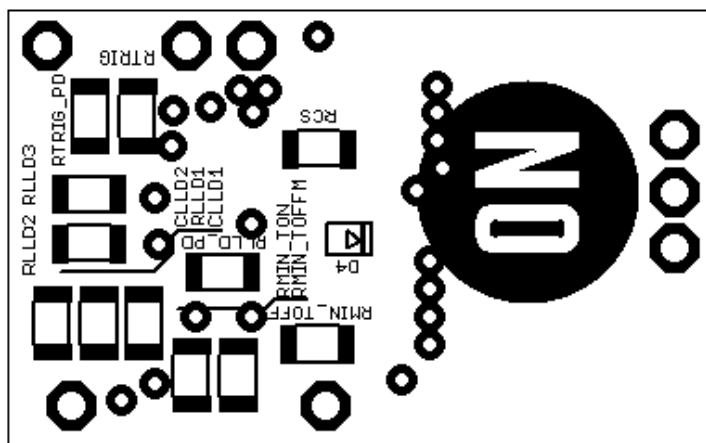

Figure 7. Bottom Side Components

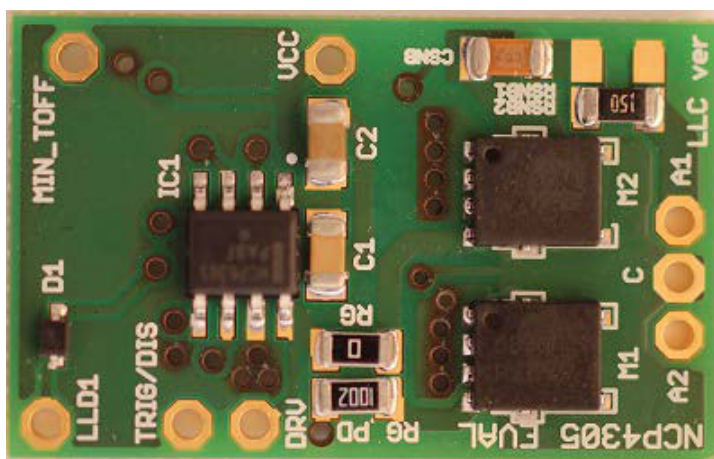

Figure 8. Evaluation Board Photo – Top Side

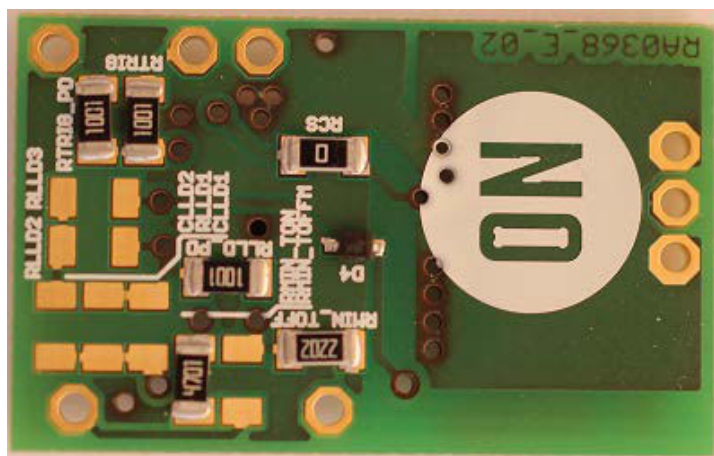

Figure 9. Evaluation Board Photo – Bottom Side

NCP4305DGEVB

Table 2. BILL OF MATERIALS FOR NCP4305 PUT-IN BOARD SO-8FL (Note 1)

Parts	Qty	Description	Value	Tolerance	Footprint	Manufacturer	Manufacturer Part Number	Substitution Allowed
C1	1	Ceramic Capacitor	100 nF	10%	1206	Kemet	C1206X104K5RACTU	Yes
C2	1	Ceramic Capacitor	1 μ F/50 V	10%	1206	Kemet	C1206X105K5RACTU	Yes
C _{LLD1} , C _{LLD2}	2	-	NU	-	1206	-	-	Yes
C _{SNB}	1	Ceramic Capacitor	3.9 nF	-	1206	Kemet	C1206C392K5RACTU	Yes
D1, D4	2	Switching Diode	BAS20HT1G	-	SOD-323	ON Semiconductor	BAS20HT1G	Yes
IC1	1	Secondary Side Synchronous Rectification Controller	NCP4305D	-	SOIC-08	ON Semiconductor	NCP4305DDR2G	No
M1, M2	2	N-Channel Power MOSFET	NVMFS5830NL	-	SO-8FL	ON Semiconductor	NVMFS5830NLT1G	Yes
R _{CS} , R _G	2	Resistor SMD	0 Ω	5%	1206	Yageo	RC1206JR-070RL	Yes
R _{G_PD}	1	Resistor SMD	10 k Ω	1%	1206	Yageo	RC1206FR-0710KL	Yes
R _{LLD_PD} , R _{TRIG} , R _{TRIG_PD}	3	Resistor SMD	1 k Ω	1%	1206	Yageo	RC1206FR-071KL	Yes
R _{LLD1} , R _{LLD2} , R _{LLD3} , R _{SNB2} , R _{MIN_TOFFML}	5	Resistor SMD	NU	-	1206	-	-	Yes
R _{MIN_TOFF}	1	Resistor SMD	22 k Ω	1%	1206	Yageo	RC1206FR-0722KL	Yes
R _{MIN_TON}	1	Resistor SMD	4.7 k Ω	1%	1206	Yageo	RC1206FR-074K7L	Yes
R _{SNB1}	1	Resistor SMD	15 Ω	1%	1206	Yageo	RC1206FR-0715RL	Yes

1. All parts are Pb-Free

onsemi, **Onsemi**, and other names, marks, and brands are registered and/or common law trademarks of Semiconductor Components Industries, LLC dba "**onsemi**" or its affiliates and/or subsidiaries in the United States and/or other countries. **onsemi** owns the rights to a number of patents, trademarks, copyrights, trade secrets, and other intellectual property. A listing of **onsemi**'s product/patent coverage may be accessed at www.onsemi.com/site/pdf/Patent-Marking.pdf. **onsemi** is an Equal Opportunity/Affirmative Action Employer. This literature is subject to all applicable copyright laws and is not for resale in any manner.

The evaluation board/kit (research and development board/kit) (hereinafter the "board") is not a finished product and is not available for sale to consumers. The board is only intended for research, development, demonstration and evaluation purposes and will only be used in laboratory/development areas by persons with an engineering/technical training and familiar with the risks associated with handling electrical/mechanical components, systems and subsystems. This person assumes full responsibility/liability for proper and safe handling. Any other use, resale or redistribution for any other purpose is strictly prohibited.

THE BOARD IS PROVIDED BY ONSEMI TO YOU "AS IS" AND WITHOUT ANY REPRESENTATIONS OR WARRANTIES WHATSOEVER. WITHOUT LIMITING THE FOREGOING, ONSEMI (AND ITS LICENSORS/SUPPLIERS) HEREBY DISCLAIMS ANY AND ALL REPRESENTATIONS AND WARRANTIES IN RELATION TO THE BOARD, ANY MODIFICATIONS, OR THIS AGREEMENT, WHETHER EXPRESS, IMPLIED, STATUTORY OR OTHERWISE, INCLUDING WITHOUT LIMITATION ANY AND ALL REPRESENTATIONS AND WARRANTIES OF MERCHANTABILITY, FITNESS FOR A PARTICULAR PURPOSE, TITLE, NON-INFRINGEMENT, AND THOSE ARISING FROM A COURSE OF DEALING, TRADE USAGE, TRADE CUSTOM OR TRADE PRACTICE.

onsemi reserves the right to make changes without further notice to any board.

You are responsible for determining whether the board will be suitable for your intended use or application or will achieve your intended results. Prior to using or distributing any systems that have been evaluated, designed or tested using the board, you agree to test and validate your design to confirm the functionality for your application. Any technical, applications or design information or advice, quality characterization, reliability data or other services provided by **onsemi** shall not constitute any representation or warranty by **onsemi**, and no additional obligations or liabilities shall arise from **onsemi** having provided such information or services.

onsemi products including the boards are not designed, intended, or authorized for use in life support systems, or any FDA Class 3 medical devices or medical devices with a similar or equivalent classification in a foreign jurisdiction, or any devices intended for implantation in the human body. You agree to indemnify, defend and hold harmless **onsemi**, its directors, officers, employees, representatives, agents, subsidiaries, affiliates, distributors, and assigns, against any and all liabilities, losses, costs, damages, judgments, and expenses, arising out of any claim, demand, investigation, lawsuit, regulatory action or cause of action arising out of or associated with any unauthorized use, even if such claim alleges that **onsemi** was negligent regarding the design or manufacture of any products and/or the board.

This evaluation board/kit does not fall within the scope of the European Union directives regarding electromagnetic compatibility, restricted substances (RoHS), recycling (WEEE), FCC, CE or UL, and may not meet the technical requirements of these or other related directives.

FCC WARNING – This evaluation board/kit is intended for use for engineering development, demonstration, or evaluation purposes only and is not considered by **onsemi** to be a finished end product fit for general consumer use. It may generate, use, or radiate radio frequency energy and has not been tested for compliance with the limits of computing devices pursuant to part 15 of FCC rules, which are designed to provide reasonable protection against radio frequency interference. Operation of this equipment may cause interference with radio communications, in which case the user shall be responsible, at its expense, to take whatever measures may be required to correct this interference.

onsemi does not convey any license under its patent rights nor the rights of others.

LIMITATIONS OF LIABILITY: **onsemi** shall not be liable for any special, consequential, incidental, indirect or punitive damages, including, but not limited to the costs of requalification, delay, loss of profits or goodwill, arising out of or in connection with the board, even if **onsemi** is advised of the possibility of such damages. In no event shall **onsemi**'s aggregate liability from any obligation arising out of or in connection with the board, under any theory of liability, exceed the purchase price paid for the board, if any.

The board is provided to you subject to the license and other terms per **onsemi**'s standard terms and conditions of sale. For more information and documentation, please visit www.onsemi.com.

ADDITIONAL INFORMATION

TECHNICAL PUBLICATIONS:

Technical Library: www.onsemi.com/design/resources/technical-documentation
onsemi Website: www.onsemi.com

ONLINE SUPPORT: www.onsemi.com/support

For additional information, please contact your local Sales Representative at www.onsemi.com/support/sales