

EMI4183

Common Mode Filter with ESD Protection

Functional Description

The EMI4183 is an integrated common mode filter providing both ESD protection and EMI filtering for high speed digital serial interfaces such as MIPI D-PHY.

The EMI4183 provides protection for three differential data line pairs in a small RoHS-compliant WDFN16 package.

Features

- Highly Integrated Common Mode Filter (CMF) with ESD Protection provides protection and EMI reduction for systems using High Speed Serial Data Lines with cost and space savings over discrete solutions
- Large Differential Mode Bandwidth with Cutoff Frequency > 2 GHz
- High Common Mode Stop Band Attenuation: >25 dB at 700 MHz, >30 dB at 800 MHz
- Provides ESD Protection to IEC61000-4-2 Level 4, ±15 kV Contact Discharge
- Low Channel Input Capacitance Provides Superior Impedance Matching Performance
- Low Profile Package with Small Footprint in WDFN16 2 x 4 mm Pb-Free Package
- These Devices are Pb-Free, Halogen Free/BFR Free and are RoHS Compliant

Applications

- MIPI D-PHY (CSI-2, DSI, etc) in Mobile Phones and Digital Still Cameras

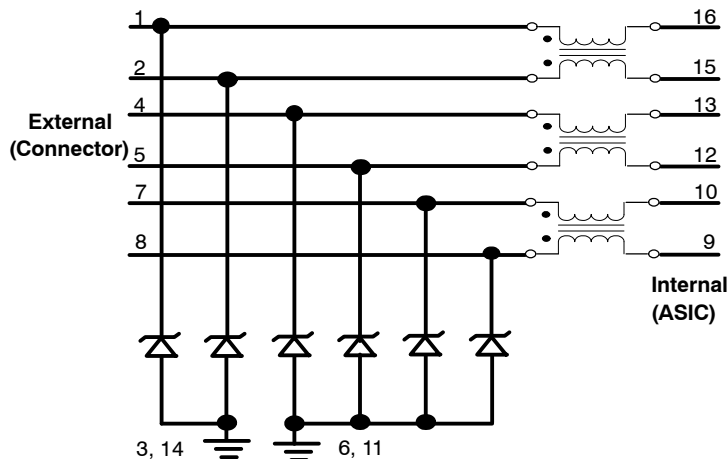
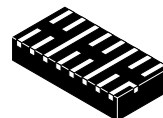

Figure 1. EMI4183 Electrical Schematic



ON Semiconductor®

<http://onsemi.com>



WDFN16
CASE 511BL

MARKING DIAGRAMS

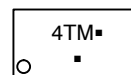

4T = Specific Device Code
M = Date Code
▪ = Pb-Free Package

(Note: Microdot may be in either location)

PIN CONNECTIONS

In_1+	1	16	Out_1+
In_1-	2	15	Out_1-
GND	3	14	GND
In_2+	4	13	Out_2+
In_2-	5	12	Out_2-
GND	6	11	GND
In_3+	7	10	Out_3+
In_3-	8	9	Out_3-

(Top View)

ORDERING INFORMATION

Device	Package	Shipping†
EMI4183MTTAG	WDFN16 (Pb-Free)	3000/Tape & Reel

† For information on tape and reel specifications, including part orientation and tape sizes, please refer to our Tape and Reel Packaging Specifications Brochure, BRD8011/D.

EMI4183

PIN FUNCTION DESCRIPTION

Pin Name	Pin No.	Type	Description
In_1+	1	I/O	CMF Channel 1+ to Connector (External)
In_1-	2	I/O	CMF Channel 1- to Connector (External)
Out_1+	16	I/O	CMF Channel 1+ to ASIC (Internal)
Out_1-	15	I/O	CMF Channel 1- to ASIC (Internal)
In_2+	4	I/O	CMF Channel 2+ to Connector (External)
In_2-	5	I/O	CMF Channel 2- to Connector (External)
Out_2+	13	I/O	CMF Channel 2+ to ASIC (Internal)
Out_2-	12	I/O	CMF Channel 2- to ASIC (Internal)
In_3+	7	I/O	CMF Channel 3+ to Connector (External)
In_3-	8	I/O	CMF Channel 3- to Connector (External)
Out_3+	10	I/O	CMF Channel 3+ to ASIC (Internal)
Out_3-	9	I/O	CMF Channel 3- to ASIC (Internal)
GND	3, 14	GND	Ground
GND	6, 11	GND	Ground

ABSOLUTE MAXIMUM RATINGS ($T_A = 25^\circ\text{C}$ unless otherwise noted)

Parameter	Symbol	Value	Unit
Operating Temperature Range	T_{OP}	-40 to +85	$^\circ\text{C}$
Storage Temperature Range	T_{STG}	-65 to +150	$^\circ\text{C}$
Maximum Lead Temperature for Soldering Purposes (1/8" from Case for 10 seconds)	T_L	260	$^\circ\text{C}$
DC Current per Line	I_{LINE}	100	mA

Stresses exceeding Maximum Ratings may damage the device. Maximum Ratings are stress ratings only. Functional operation above the Recommended Operating Conditions is not implied. Extended exposure to stresses above the Recommended Operating Conditions may affect device reliability.

EMI4183

ELECTRICAL CHARACTERISTICS ($T_A = 25^\circ\text{C}$ unless otherwise noted)

Symbol	Parameter	Test Conditions	Min	Typ	Max	Unit
I_{LEAK}	Channel Leakage Current	$T_A = 25^\circ\text{C}$, $V_{IN} = 5\text{ V}$, $\text{GND} = 0\text{ V}$			1.0	μA
V_F	Channel Negative Voltage	$T_A = 25^\circ\text{C}$, $I_F = 10\text{ mA}$	0.1		1.5	V
C_{IN}	Channel Input Capacitance to Ground (Pins 1,2,4,5,7,8 to Pins 3,6,11,14)	$T_A = 25^\circ\text{C}$, At 1 MHz, $\text{GND} = 0\text{ V}$, $V_{IN} = 1.65\text{ V}$		0.8	1.3	pF
R_{CH}	Channel Resistance (Pins 1–16, 2–15, 4–13, 5–12, 7–10 & 8–9)			8.0		Ω
f_{3dB}	Differential Mode Cut-off Frequency	50 Ω Source and Load Termination		2.0		GHz
F_{atten}	Common Mode Stop Band Attenuation	@ 800 MHz		30		dB
V_{ESD}	In-system ESD Withstand Voltage a) Contact discharge per IEC 61000–4–2 standard, Level 4 (External Pins) b) Contact discharge per IEC 61000–4–2 standard, Level 1 (Internal Pins)	(Notes 1 and 2)	± 15 ± 2			kV
V_{CL}	TLP Clamping Voltage (See Figure 12)	Forward $I_{PP} = 8\text{ A}$ Forward $I_{PP} = 16\text{ A}$ Forward $I_{PP} = -8\text{ A}$ Forward $I_{PP} = -16\text{ A}$		12 18 -6 -12		V V V V
R_{DYN}	Dynamic Resistance Positive Transients Negative Transients	$T_A = 25^\circ\text{C}$, $I_{PP} = 1\text{ A}$, $t_p = 8/20\ \mu\text{s}$ Any I/O pin to Ground; Notes 1 and 3		1.36 0.6		
V_{RWM}	Reverse Working Voltage	(Note 3)			5.0	V
V_{BR}	Breakdown Voltage	$I_T = 1\text{ mA}$; (Note 4)	5.6		9.0	V

- Standard IEC61000–4–2 with $C_{Discharge} = 150\text{ pF}$, $R_{Discharge} = 330$, GND grounded.
- These measurements performed with no external capacitor.
- TVS devices are normally selected according to the working peak reverse voltage (V_{RWM}), which should be equal to or greater than the DC or continuous peak operating voltage level.
- V_{BR} is measured at pulse test current I_T .

TYPICAL CHARACTERISTICS

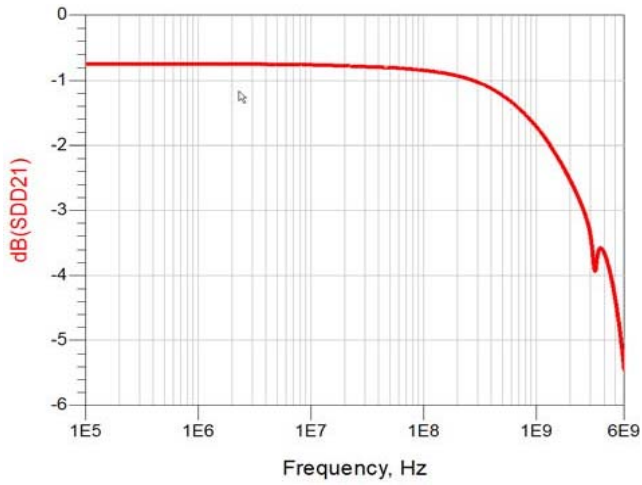

Figure 2. Differential Mode Attenuation vs. Frequency ($Z_{diff} = 100 \Omega$)

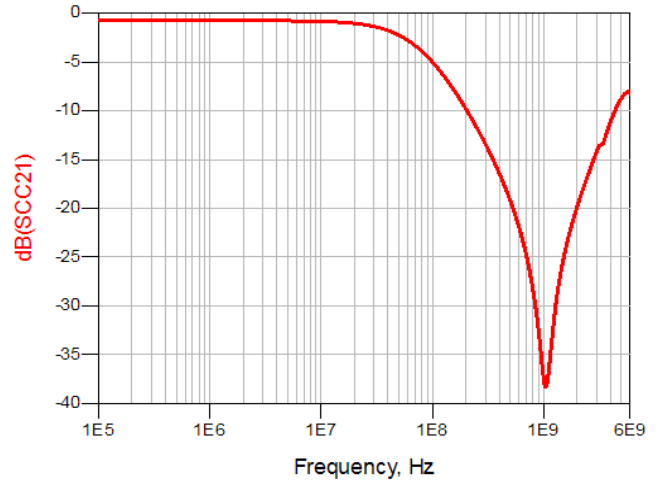

Figure 3. Common Mode Attenuation vs. Frequency ($Z_{comm} = 50 \Omega$)

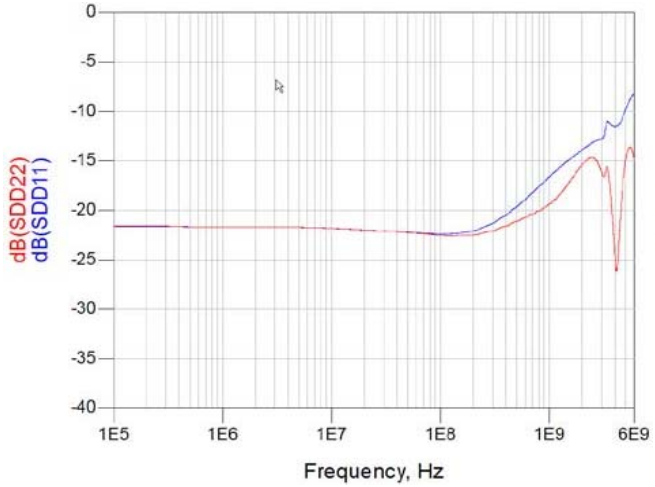

Figure 4. Differential Return Loss vs. Frequency ($Z_{diff}=100 \Omega$)

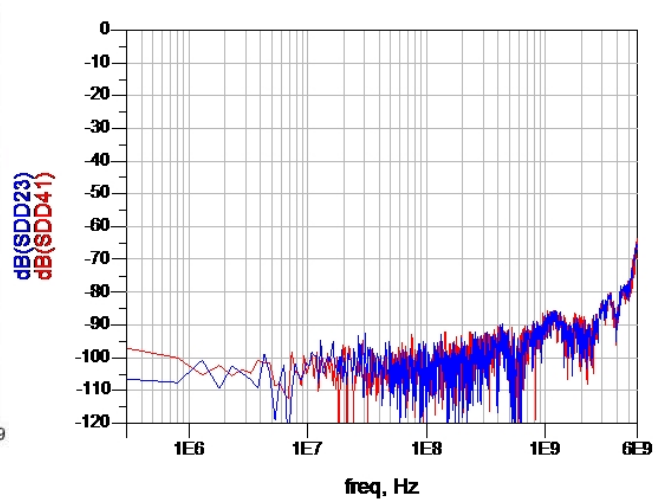

Figure 5. Differential Inter-Lane Cross-Coupling

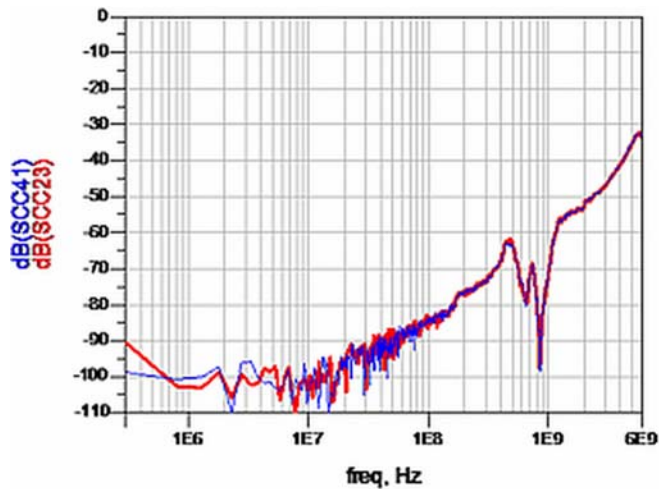

Figure 6. Common Mode Inter-Lane Cross-Coupling

EMI4183

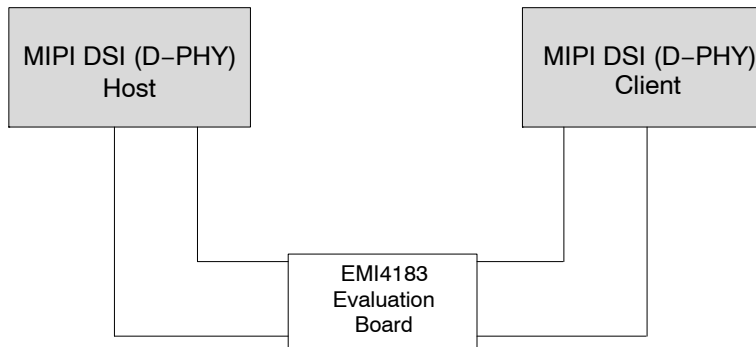

Figure 7. MIPI D-PHY LP Mode Test Setup



Figure 8. EMI4183 MIPI D-PHY LP Mode Measured Results

EMI4183

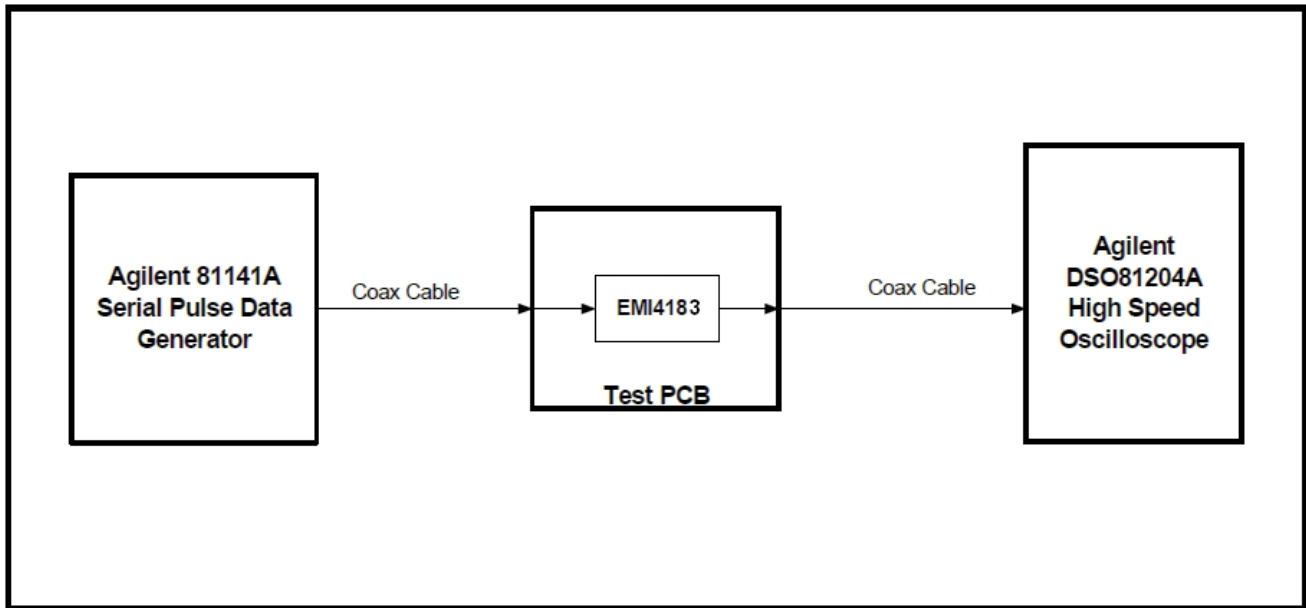

Figure 9. EMI4183 Eye Diagram Test Setup



Figure 10. EMI4183 Measured Eye Diagram @ 3.4Gbps (EVB through on left, EVB with EMI4183 on right)

Transmission Line Pulse (TLP) Measurements

Transmission Line Pulse (TLP) provides current versus voltage (I-V) curves in which each data point is obtained from a 100 ns long rectangular pulse from a charged transmission line. A simplified schematic of a typical TLP system is shown in Figure 11. TLP I-V curves of ESD protection devices accurately demonstrate the product’s ESD capability because the 10 s of amps current levels and under 100 ns time scale match those of an ESD event. This is illustrated in Figure 12 where an 8 kV IEC61000-4-2 current waveform is compared with TLP current pulses at 8 and 16 A. A TLP curve shows the voltage at which the device turns on as well as how well the device clamps voltage over a range of current levels. Typical TLP I-V curves for the EMI4183 are shown in Figure 13.

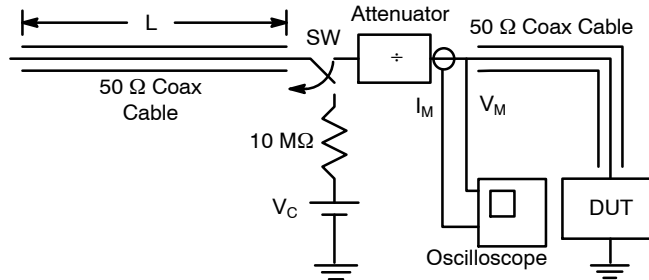

Figure 11. Simplified Schematic of a Typical TLP System

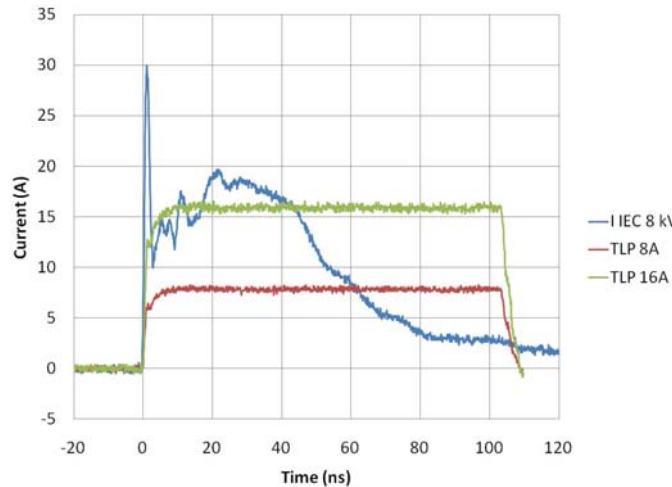

Figure 12. Comparison Between 8 kV IEC61000-4-2 and 8 A and 16 A TLP Waveforms

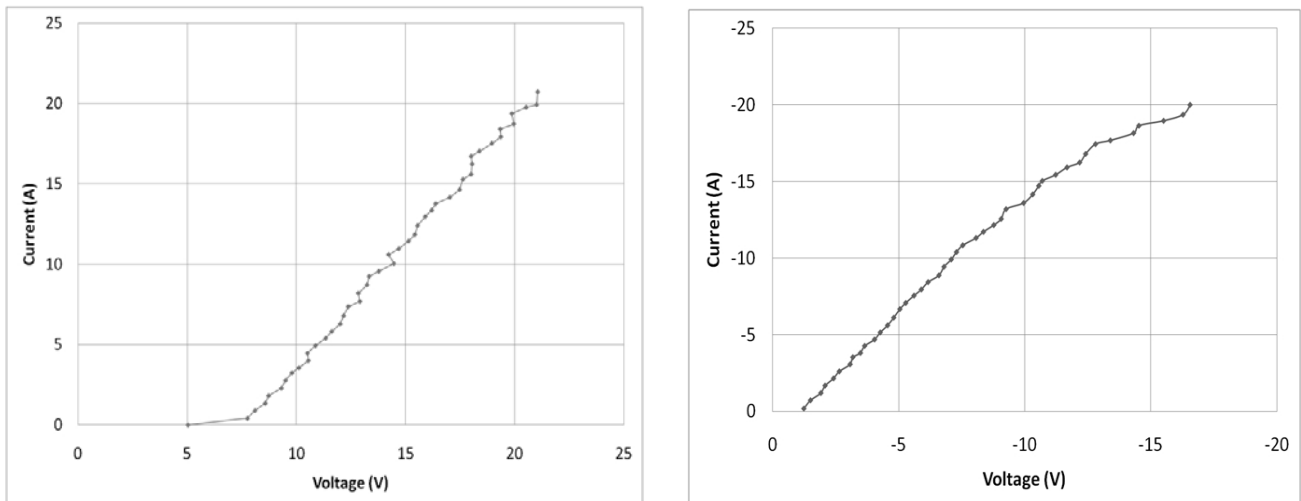

Figure 13. Positive and Negative TLP Waveforms

ESD Voltage Clamping

For sensitive circuit elements it is important to limit the voltage that an IC will be exposed to during an ESD event to as low a voltage as possible. The ESD clamping voltage is the voltage drop across the ESD protection diode during an ESD event per the IEC61000-4-2 waveform. Since the IEC61000-4-2 was written as a pass/fail spec for larger systems such as cell phones or laptop computers it is not clearly defined in the spec how to specify a clamping voltage at the device level. ON Semiconductor has developed a way to examine the entire voltage waveform across the ESD protection diode over the time domain of an ESD pulse in the form of an oscilloscope screenshot, which can be found on the datasheets for all ESD protection diodes. For more information on how ON Semiconductor creates these screenshots and how to interpret them please refer to On Semiconductor Application Notes AND8307/D and AND8308/D.

IEC61000-4-2 Spec.

Level	Test Voltage (kV)	First Peak Current (A)	Current at 30 ns (A)	Current at 60 ns (A)
1	2	7.5	4	2
2	4	15	8	4
3	6	22.5	12	6
4	8	30	16	8

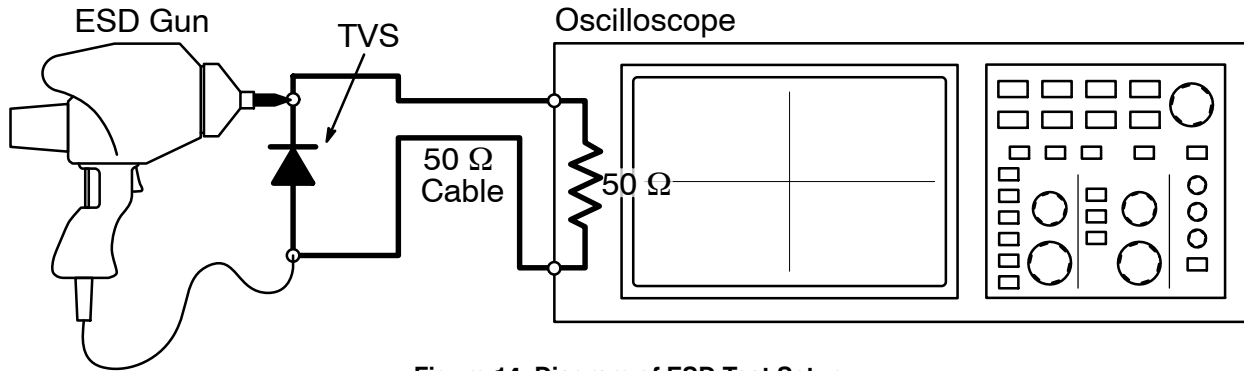
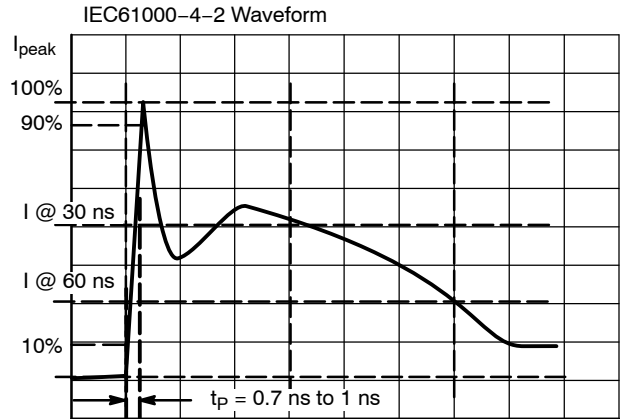

Figure 14. Diagram of ESD Test Setup

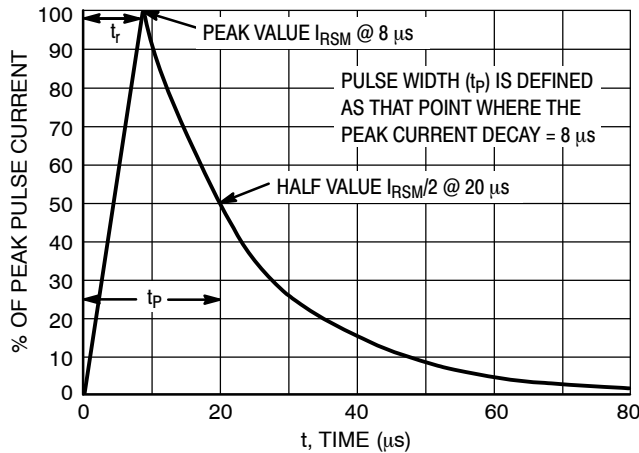

Figure 15. 8 x 20 μs Pulse Waveform

EMI4183

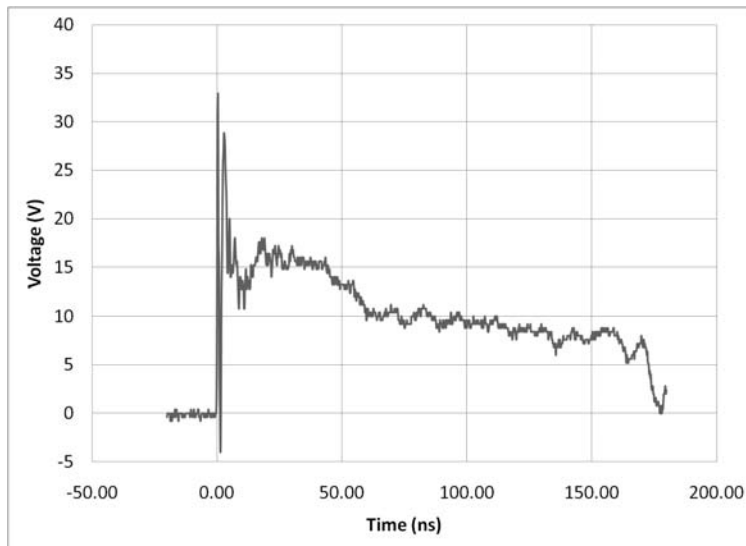

Figure 16. ESD Clamping Voltage +8 kV per IEC6100-4-2 (external to internal pin)

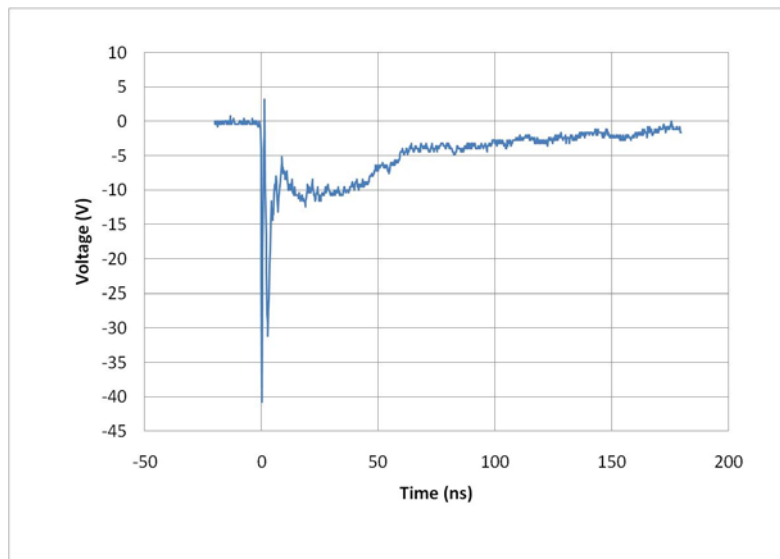

Figure 17. ESD Clamping Voltage -8 kV per IEC6100-4-2 (external to internal pin)

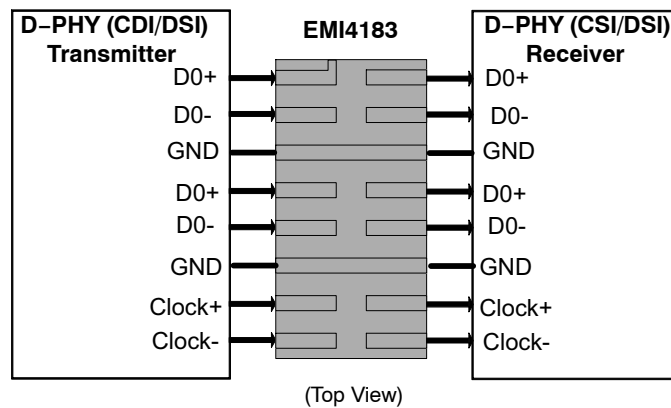
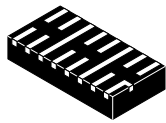

Figure 18. EMI4183 MIPI D-PHY Application Diagram

MECHANICAL CASE OUTLINE

PACKAGE DIMENSIONS

ON Semiconductor®



WDFN16 4x2, 0.5P
CASE 511BL-01
ISSUE O

DATE 29 JUN 2010

SCALE 4:1

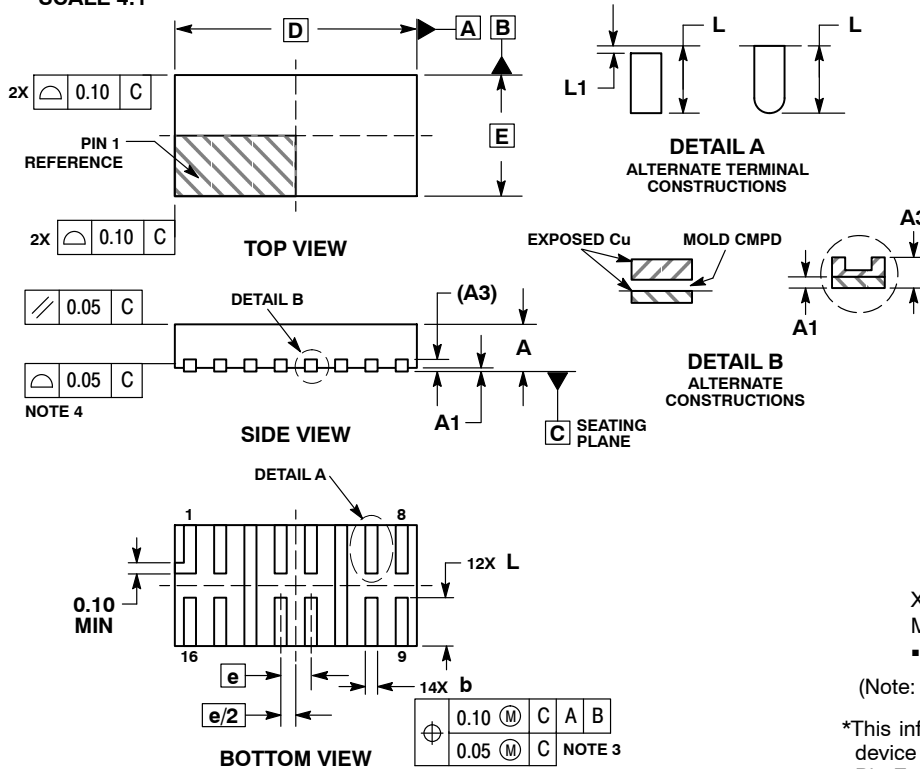

NOTES:

1. DIMENSIONING AND TOLERANCING PER ASME Y14.5M, 1994.
2. CONTROLLING DIMENSION: MILLIMETERS.
3. DIMENSIONS b APPLIES TO PLATED TERMINAL AND IS MEASURED BETWEEN 0.15 AND 0.30 MM FROM TERMINAL TIP.
4. COPLANARITY APPLIES TO THE EXPOSED PAD AS WELL AS THE TERMINALS.

DIM	MILLIMETERS	
	MIN	MAX
A	0.70	0.80
A1	0.00	0.05
A3	0.20 REF	
b	0.15	0.25
D	4.00 BSC	
E	2.00 BSC	
e	0.50 BSC	
L	0.70	0.90
L1	0.05	0.15

GENERIC MARKING DIAGRAM*

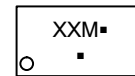

- XX = Specific Device Code
- M = Date Code
- = Pb-Free Package

(Note: Microdot may be in either location)

*This information is generic. Please refer to device data sheet for actual part marking. Pb-Free indicator, "G" or microdot "▪", may or may not be present.

RECOMMENDED MOUNTING FOOTPRINT

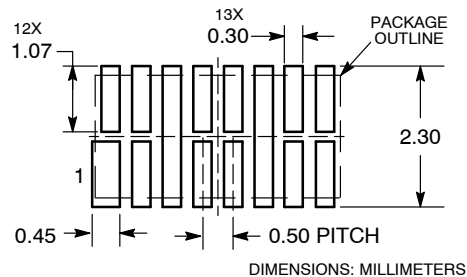

DOCUMENT NUMBER:	98AON52150E	Electronic versions are uncontrolled except when accessed directly from the Document Repository. Printed versions are uncontrolled except when stamped "CONTROLLED COPY" in red.
DESCRIPTION:	WDFN16 4X2, 0.5P	PAGE 1 OF 1

ON Semiconductor and ON are trademarks of Semiconductor Components Industries, LLC dba ON Semiconductor or its subsidiaries in the United States and/or other countries. ON Semiconductor reserves the right to make changes without further notice to any products herein. ON Semiconductor makes no warranty, representation or guarantee regarding the suitability of its products for any particular purpose, nor does ON Semiconductor assume any liability arising out of the application or use of any product or circuit, and specifically disclaims any and all liability, including without limitation special, consequential or incidental damages. ON Semiconductor does not convey any license under its patent rights nor the rights of others.

onsemi, **Onsemi**, and other names, marks, and brands are registered and/or common law trademarks of Semiconductor Components Industries, LLC dba "**onsemi**" or its affiliates and/or subsidiaries in the United States and/or other countries. **onsemi** owns the rights to a number of patents, trademarks, copyrights, trade secrets, and other intellectual property. A listing of **onsemi**'s product/patent coverage may be accessed at www.onsemi.com/site/pdf/Patent-Marking.pdf. **onsemi** reserves the right to make changes at any time to any products or information herein, without notice. The information herein is provided "as-is" and **onsemi** makes no warranty, representation or guarantee regarding the accuracy of the information, product features, availability, functionality, or suitability of its products for any particular purpose, nor does **onsemi** assume any liability arising out of the application or use of any product or circuit, and specifically disclaims any and all liability, including without limitation special, consequential or incidental damages. Buyer is responsible for its products and applications using **onsemi** products, including compliance with all laws, regulations and safety requirements or standards, regardless of any support or applications information provided by **onsemi**. "Typical" parameters which may be provided in **onsemi** data sheets and/or specifications can and do vary in different applications and actual performance may vary over time. All operating parameters, including "Typicals" must be validated for each customer application by customer's technical experts. **onsemi** does not convey any license under any of its intellectual property rights nor the rights of others. **onsemi** products are not designed, intended, or authorized for use as a critical component in life support systems or any FDA Class 3 medical devices or medical devices with a same or similar classification in a foreign jurisdiction or any devices intended for implantation in the human body. Should Buyer purchase or use **onsemi** products for any such unintended or unauthorized application, Buyer shall indemnify and hold **onsemi** and its officers, employees, subsidiaries, affiliates, and distributors harmless against all claims, costs, damages, and expenses, and reasonable attorney fees arising out of, directly or indirectly, any claim of personal injury or death associated with such unintended or unauthorized use, even if such claim alleges that **onsemi** was negligent regarding the design or manufacture of the part. **onsemi** is an Equal Opportunity/Affirmative Action Employer. This literature is subject to all applicable copyright laws and is not for resale in any manner.

ADDITIONAL INFORMATION

TECHNICAL PUBLICATIONS:

Technical Library: www.onsemi.com/design/resources/technical-documentation
onsemi Website: www.onsemi.com

ONLINE SUPPORT: www.onsemi.com/support

For additional information, please contact your local Sales Representative at www.onsemi.com/support/sales