

MOSFET – Power, P-Channel Single ECH8

-30 V, -9 A, 17 mΩ

ECH8310

Features

- 4 V Drive
- Halogen free compliance
- Protection diode in
- This Device is Pb-Free, Halogen Free and RoHS Compliant

Specifications

ABSOLUTE MAXIMUM RATINGS (T_A = 25°C)

Symbol	Parameter	Conditions	Ratings	Unit
V _{DSS}	Drain-to-Source Voltage		-30	V
V _{GSS}	Gate-to-Source Voltage		±20	V
I _D	Drain Current (DC)		-9	A
I _{DP}	Drain Current (Pulse)	PW ≤ 10 μs, duty cycle ≤ 1%	-60	A
P _D	Allowable Power Dissipation	When mounted on ceramic substrate (900 mm ² X 0.8 mm)	1.5	W
T _{ch}	Channel Temperature		150	°C
T _{stg}	Storage Temperature		-55 to +150	°C

Stresses exceeding those listed in the Maximum Ratings table may damage the device. If any of these limits are exceeded, device functionality should not be assumed, damage may occur and reliability may be affected.

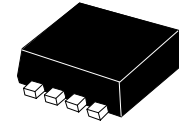

SOT-28FL/ECH8
CASE 318BF

ELECTRICAL CONNECTION

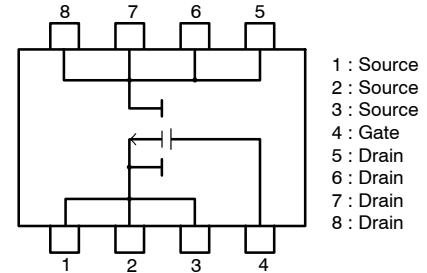

MARKING DIAGRAM

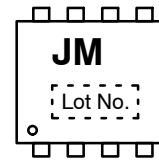

ORDERING INFORMATION

Device	Package	Shipping [†]
ECH8310-TL-H	SOT-28FL ECH8 (Pb-Free)	3000 / Tape & Reel

[†]For information on tape and reel specifications, including part orientation and tape sizes, please refer to our Tape and Reel Packaging Specifications Brochure, [BRD8011/D](#).

ECH8310

ELECTRICAL CHARACTERISTICS ($T_A = 25^\circ\text{C}$)

Symbol	Parameter	Conditions	Ratings			Unit
			Min	Typ	Max	
$V_{(BR)DSS}$	Drain-to-Source Breakdown Voltage	$I_D = -1 \text{ mA}, V_{GS} = 0 \text{ V}$	-30	-	-	V
I_{DSS}	Zero-Gate Voltage Drain Current	$V_{DS} = -30 \text{ V}, V_{GS} = 0 \text{ V}$	-	-	-1	μA
I_{GSS}	Gate-to-Source Leakage Current	$V_{GS} = \pm 16 \text{ V}, V_{DS} = 0 \text{ V}$	-	-	± 10	μA
$V_{GS(off)}$	Cutoff Voltage	$V_{DS} = -10 \text{ V}, I_D = -1 \text{ mA}$	-1.2	-	-2.6	V
$ y_{fs} $	Forward Transfer Admittance	$V_{DS} = -10 \text{ V}, I_D = -4.5 \text{ A}$	-	12	-	S
$R_{DS(on)1}$	Static Drain to Source On-State Resistance	$I_D = -4.5 \text{ A}, V_{GS} = -10 \text{ V}$	9	13	17	$\text{m}\Omega$
$R_{DS(on)2}$		$I_D = -2 \text{ A}, V_{GS} = -4.5 \text{ V}$	12	20	28	$\text{m}\Omega$
$R_{DS(on)3}$		$I_D = -2 \text{ A}, V_{GS} = -4.0 \text{ V}$	13.5	23	32.5	$\text{m}\Omega$
C_{iss}	Input Capacitance	$V_{DS} = -10 \text{ V}, f = 1 \text{ MHz}$	-	1400	-	pF
C_{oss}	Output Capacitance		-	350	-	pF
C_{rss}	Reverse Transfer Capacitance		-	250	-	pF
$t_{d(on)}$	Turn-ON Delay Time	See specified Test Circuit.	-	10	-	ns
t_r	Rise Time		-	45	-	ns
$t_{d(off)}$	Turn-OFF Delay Time		-	134	-	ns
t_f	Fall Time		-	87	-	ns
Q_g	Total Gate Charge	$V_{DS} = -15 \text{ V}, V_{GS} = -10 \text{ V}, I_D = -9 \text{ A}$	-	28	-	nC
Q_{gs}	Gate-to-Source Charge		-	4	-	nC
Q_{gd}	Gate-to-Drain "Miller" Charge		-	6	-	nC
V_{SD}	Diode Forward Voltage	$I_S = -9 \text{ A}, V_{GS} = 0 \text{ V}$	-	-0.8	-1.2	V

Product parametric performance is indicated in the Electrical Characteristics for the listed test conditions, unless otherwise noted. Product performance may not be indicated by the Electrical Characteristics if operated under different conditions.

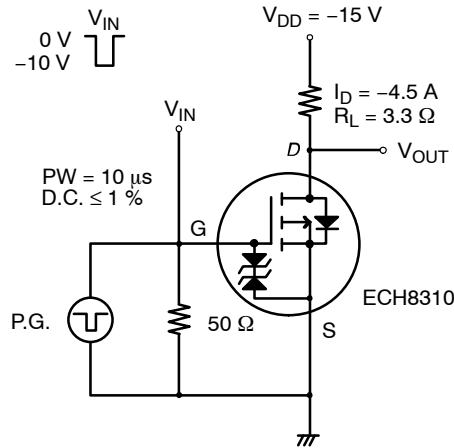
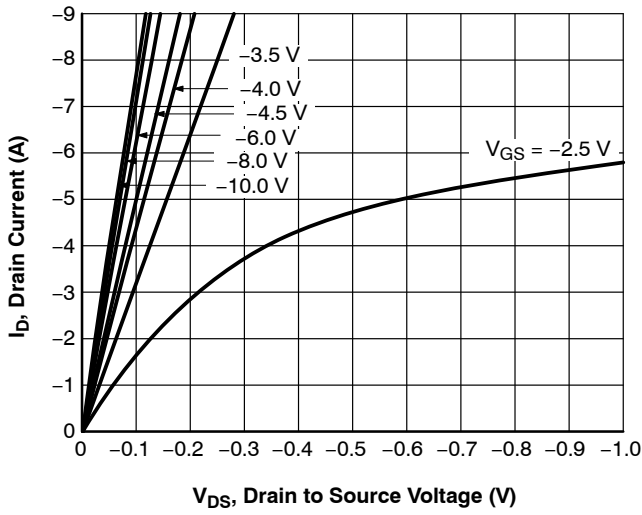

Figure 1. Switching Time Test Circuit

TYPICAL CHARACTERISTICS



V_{DS} , Drain to Source Voltage (V)

Figure 2. $I_D - V_{DS}$

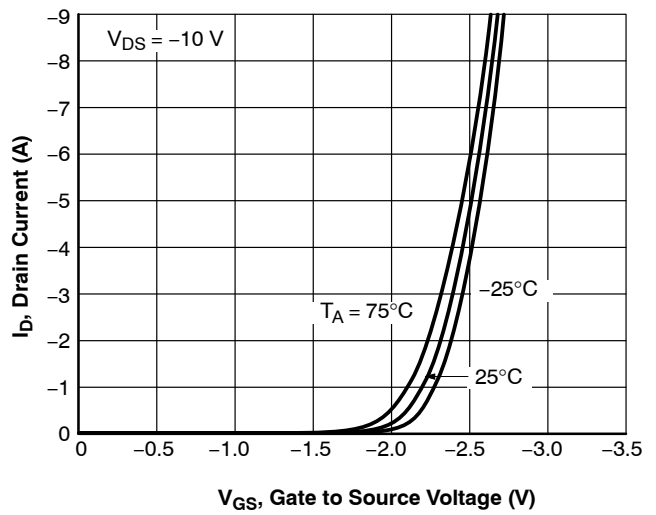

V_{GS} , Gate to Source Voltage (V)

Figure 3. $I_D - V_{GS}$

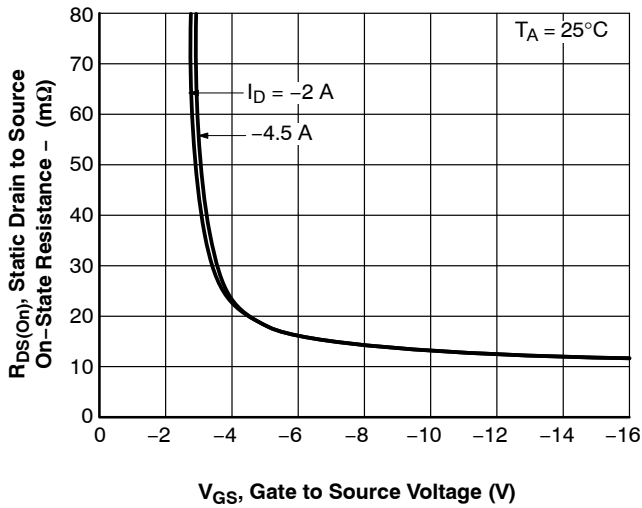

V_{GS} , Gate to Source Voltage (V)

Figure 4. $R_{DS(on)} - V_{GS}$

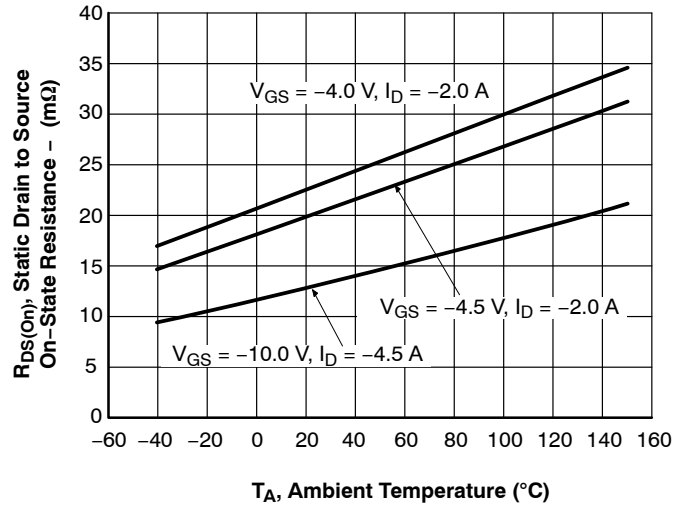

T_A , Ambient Temperature ($^{\circ}C$)

Figure 5. $R_{DS(on)} - T_A$

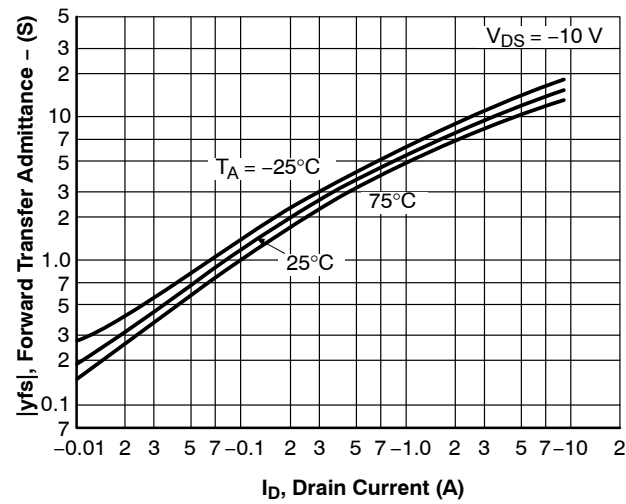

I_D , Drain Current (A)

Figure 6. $|Y_{fs}| - I_D$

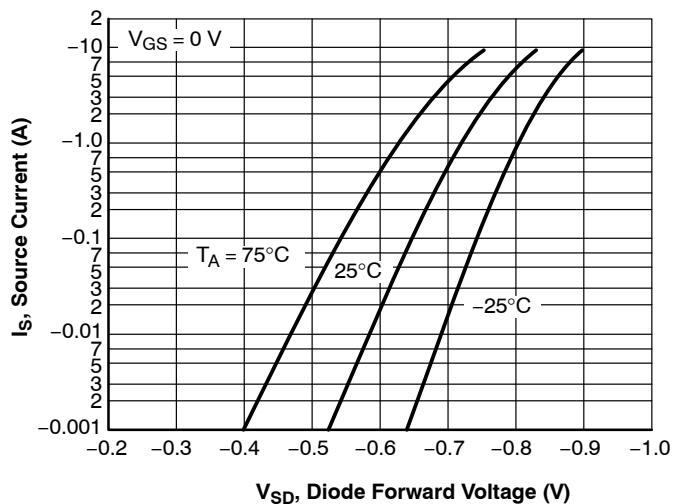

V_{SD} , Diode Forward Voltage (V)

Figure 7. $I_S - V_{SD}$

ECH8310

TYPICAL CHARACTERISTICS (CONTINUED)

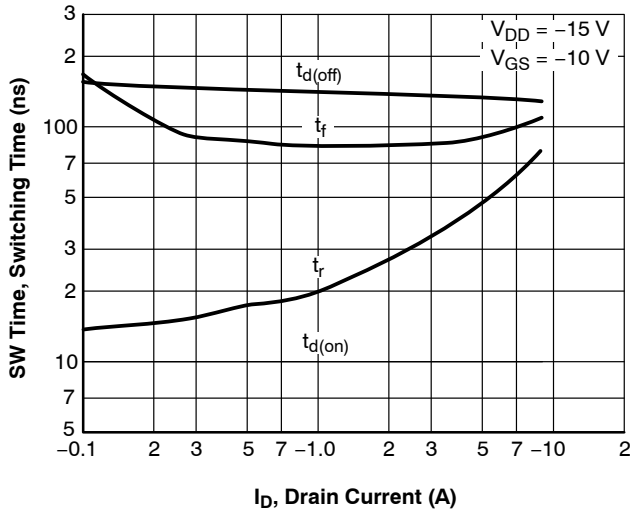

Figure 8. $I_D - S/W$ Time

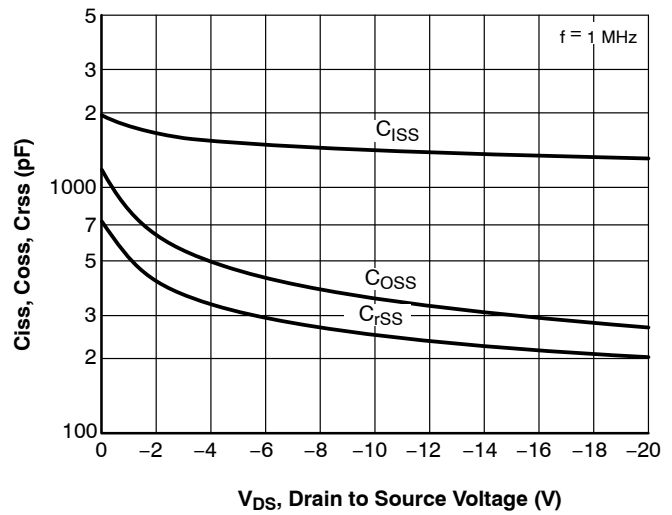

Figure 9. $C_{iss}, C_{oss}, C_{rss} - V_{DS}$

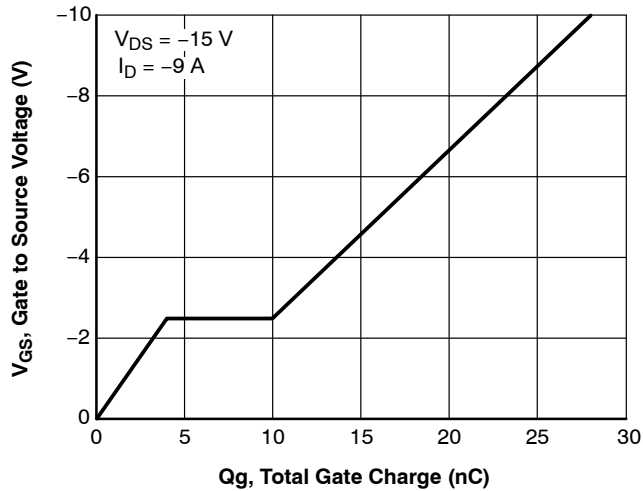

Figure 10. $V_{GS} - Q_g$

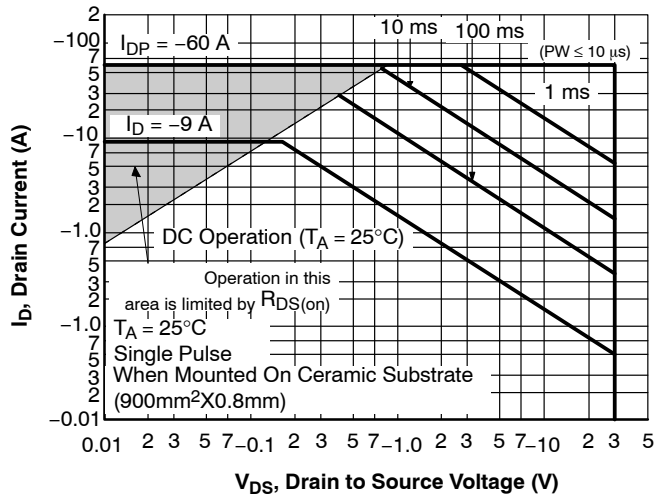

Figure 11. S O A

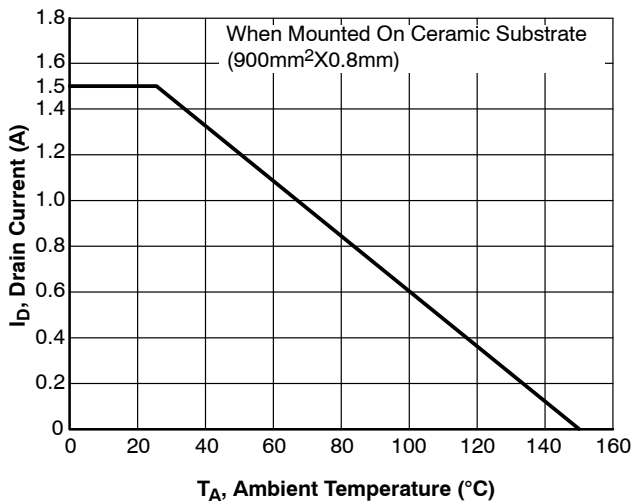

Figure 12. $I_D - T_A$

Note on usage : Since the ECH8310 is a MOSFET product, please avoid using this device in the vicinity of highly charged objects.

MECHANICAL CASE OUTLINE
PACKAGE DIMENSIONS

SOT-28FL / ECH8
CASE 318BF
ISSUE O

DATE 31 MAR 2012

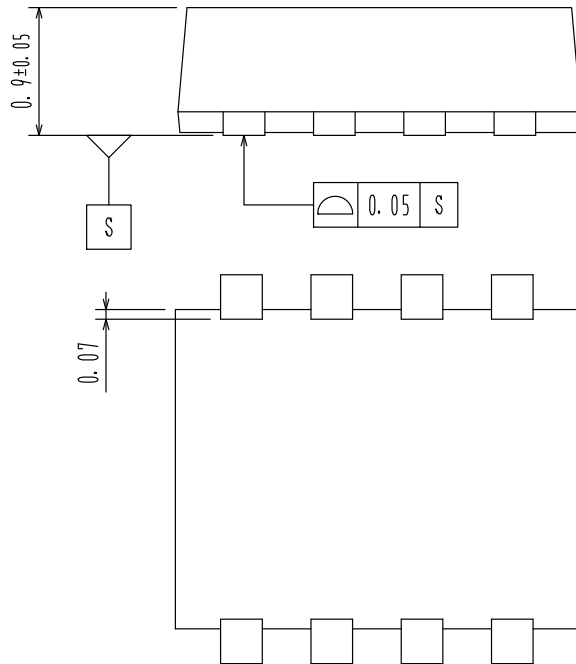
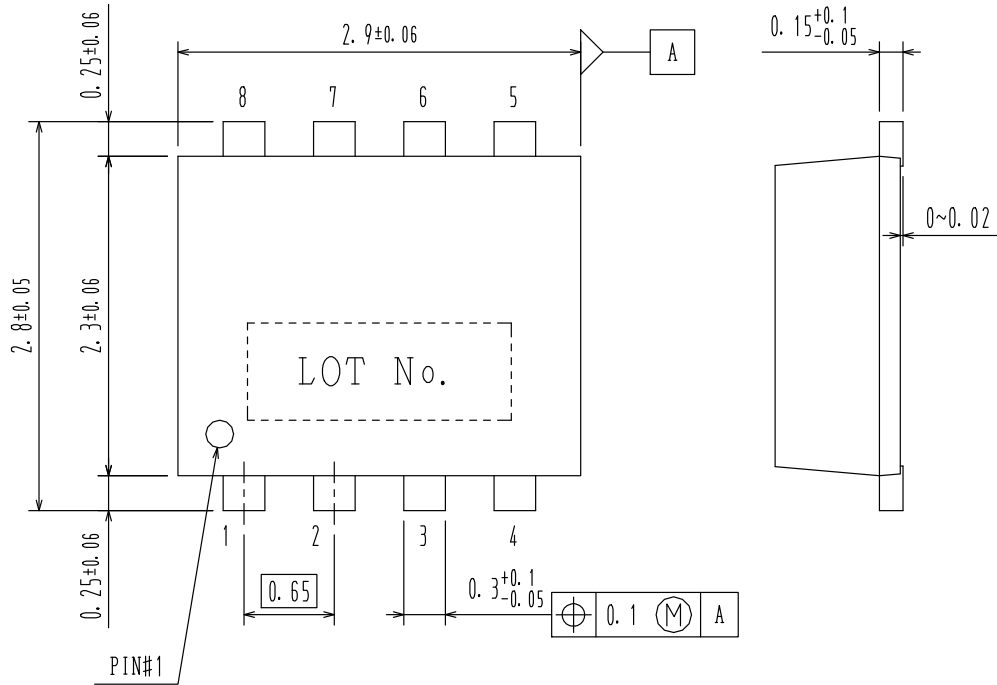

DOCUMENT NUMBER:	98AON78700E	Electronic versions are uncontrolled except when accessed directly from the Document Repository. Printed versions are uncontrolled except when stamped "CONTROLLED COPY" in red.
DESCRIPTION:	SOT-28FL / ECH8	PAGE 1 OF 1

ON Semiconductor and are trademarks of Semiconductor Components Industries, LLC dba ON Semiconductor or its subsidiaries in the United States and/or other countries. ON Semiconductor reserves the right to make changes without further notice to any products herein. ON Semiconductor makes no warranty, representation or guarantee regarding the suitability of its products for any particular purpose, nor does ON Semiconductor assume any liability arising out of the application or use of any product or circuit, and specifically disclaims any and all liability, including without limitation special, consequential or incidental damages. ON Semiconductor does not convey any license under its patent rights nor the rights of others.

onsemi, **Onsemi**, and other names, marks, and brands are registered and/or common law trademarks of Semiconductor Components Industries, LLC dba "**onsemi**" or its affiliates and/or subsidiaries in the United States and/or other countries. **onsemi** owns the rights to a number of patents, trademarks, copyrights, trade secrets, and other intellectual property. A listing of **onsemi**'s product/patent coverage may be accessed at www.onsemi.com/site/pdf/Patent-Marking.pdf. **onsemi** reserves the right to make changes at any time to any products or information herein, without notice. The information herein is provided "as-is" and **onsemi** makes no warranty, representation or guarantee regarding the accuracy of the information, product features, availability, functionality, or suitability of its products for any particular purpose, nor does **onsemi** assume any liability arising out of the application or use of any product or circuit, and specifically disclaims any and all liability, including without limitation special, consequential or incidental damages. Buyer is responsible for its products and applications using **onsemi** products, including compliance with all laws, regulations and safety requirements or standards, regardless of any support or applications information provided by **onsemi**. "Typical" parameters which may be provided in **onsemi** data sheets and/or specifications can and do vary in different applications and actual performance may vary over time. All operating parameters, including "Typicals" must be validated for each customer application by customer's technical experts. **onsemi** does not convey any license under any of its intellectual property rights nor the rights of others. **onsemi** products are not designed, intended, or authorized for use as a critical component in life support systems or any FDA Class 3 medical devices or medical devices with a same or similar classification in a foreign jurisdiction or any devices intended for implantation in the human body. Should Buyer purchase or use **onsemi** products for any such unintended or unauthorized application, Buyer shall indemnify and hold **onsemi** and its officers, employees, subsidiaries, affiliates, and distributors harmless against all claims, costs, damages, and expenses, and reasonable attorney fees arising out of, directly or indirectly, any claim of personal injury or death associated with such unintended or unauthorized use, even if such claim alleges that **onsemi** was negligent regarding the design or manufacture of the part. **onsemi** is an Equal Opportunity/Affirmative Action Employer. This literature is subject to all applicable copyright laws and is not for resale in any manner.

ADDITIONAL INFORMATION

TECHNICAL PUBLICATIONS:

Technical Library: www.onsemi.com/design/resources/technical-documentation
onsemi Website: www.onsemi.com

ONLINE SUPPORT: www.onsemi.com/support

For additional information, please contact your local Sales Representative at www.onsemi.com/support/sales