

# Dual NPN Bias Resistor Transistors

## R1 = 1 kΩ, R2 = 1 kΩ

NPN Transistors with Monolithic Bias Resistor Network

### MUN5230DW1, NSBC113EDXV6

This series of digital transistors is designed to replace a single device and its external resistor bias network. The Bias Resistor Transistor (BRT) contains a single transistor with a monolithic bias network consisting of two resistors; a series base resistor and a base-emitter resistor. The BRT eliminates these individual components by integrating them into a single device. The use of a BRT can reduce both system cost and board space.

#### Features

- Simplifies Circuit Design
- Reduces Board Space
- Reduces Component Count
- S and NSV Prefix for Automotive and Other Applications Requiring Unique Site and Control Change Requirements; AEC-Q101 Qualified and PPAP Capable
- These Devices are Pb-Free, Halogen Free/BFR Free and are RoHS Compliant

#### MAXIMUM RATINGS

(T<sub>A</sub> = 25°C, common for Q<sub>1</sub> and Q<sub>2</sub>, unless otherwise noted)

Rating	Symbol	Max	Unit
Collector-Base Voltage	V <sub>CBO</sub>	50	Vdc
Collector-Emitter Voltage	V <sub>CEO</sub>	50	Vdc
Collector Current – Continuous	I <sub>C</sub>	100	mAdc
Input Forward Voltage	V <sub>IN(fwd)</sub>	10	Vdc
Input Reverse Voltage	V <sub>IN(rev)</sub>	10	Vdc

Stresses exceeding those listed in the Maximum Ratings table may damage the device. If any of these limits are exceeded, device functionality should not be assumed, damage may occur and reliability may be affected.

#### PIN CONNECTIONS

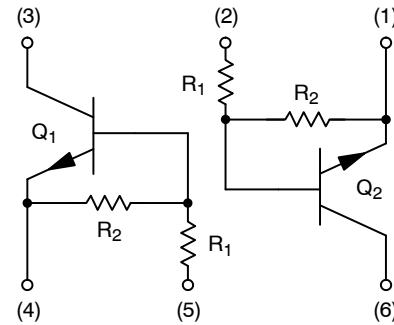

#### MARKING DIAGRAMS



SOT-363  
CASE 419B

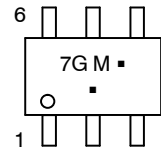

SOT-563  
CASE 463A

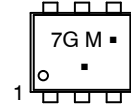

7G = Specific Device Code  
M = Date Code\*  
▪ = Pb-Free Package

(Note: Microdot may be in either location)

\*Date Code orientation may vary depending upon manufacturing location.

#### ORDERING INFORMATION

See detailed ordering, marking, and shipping information on page 2 of this data sheet.

NOTE: Some of the devices on this data sheet have been **DISCONTINUED**. Please refer to the table on page 2.

# MUN5230DW1, NSBC113EDXV6

## ORDERING INFORMATION

Device	Package	Shipping†
MUN5230DW1T1G, SMUN5230DW1T1G	SOT-363	3,000 / Tape & Reel

### DISCONTINUED (Note 1)

NSBC113EDXV6T1G	SOT-563	4,000 / Tape & Reel
-----------------	---------	---------------------

†For information on tape and reel specifications, including part orientation and tape sizes, please refer to our Tape and Reel Packaging Specifications Brochure, BRD8011/D.

1. **DISCONTINUED:** This device is not recommended for new design. Please contact your **onsemi** representative for information. The most current information on this device may be available on [www.onsemi.com](http://www.onsemi.com).

## THERMAL CHARACTERISTICS

Characteristic	Symbol	Max	Unit
----------------	--------	-----	------

### MUN5230DW1 (SOT-363) ONE JUNCTION HEATED

Total Device Dissipation $T_A = 25^\circ\text{C}$ (Note 2)	$P_D$	187	mW
Derate above $25^\circ\text{C}$ (Note 3)		256	
		1.5	mW/ $^\circ\text{C}$
		2.0	
Thermal Resistance, Junction to Ambient (Note 2)	$R_{\theta JA}$	670	$^\circ\text{C}/\text{W}$
(Note 3)		490	

### MUN5230DW1 (SOT-363) BOTH JUNCTION HEATED (Note 4)

Total Device Dissipation $T_A = 25^\circ\text{C}$ (Note 2)	$P_D$	250	mW
Derate above $25^\circ\text{C}$ (Note 3)		385	
		2.0	mW/ $^\circ\text{C}$
		3.0	
Thermal Resistance, Junction to Ambient (Note 2)	$R_{\theta JA}$	493	$^\circ\text{C}/\text{W}$
(Note 3)		325	
Thermal Resistance, Junction to Lead (Note 2)	$R_{\theta JL}$	188	$^\circ\text{C}/\text{W}$
(Note 3)		208	
Junction and Storage Temperature Range	$T_J, T_{stg}$	-55 to +150	$^\circ\text{C}$

### NSBC113EDXV6 (SOT-563) ONE JUNCTION HEATED

Total Device Dissipation $T_A = 25^\circ\text{C}$ (Note 2)	$P_D$	357	mW
Derate above $25^\circ\text{C}$ (Note 2)		2.9	
Thermal Resistance, Junction to Ambient (Note 2)	$R_{\theta JA}$	350	$^\circ\text{C}/\text{W}$

### NSBC113EDXV6 (SOT-563) BOTH JUNCTION HEATED (Note 4)

Total Device Dissipation $T_A = 25^\circ\text{C}$ (Note 2)	$P_D$	500	mW
Derate above $25^\circ\text{C}$ (Note 2)		4.0	
Thermal Resistance, Junction to Ambient (Note 2)	$R_{\theta JA}$	250	$^\circ\text{C}/\text{W}$
Junction and Storage Temperature Range	$T_J, T_{stg}$	-55 to +150	$^\circ\text{C}$

2. FR-4 @ Minimum Pad.

3. FR-4 @ 1.0 × 1.0 Inch Pad.

4. Both junction heated values assume total power is sum of two equally powered channels.

# MUN5230DW1, NSBC113EDXV6

## ELECTRICAL CHARACTERISTICS ( $T_A = 25^\circ\text{C}$ , common for $Q_1$ and $Q_2$ , unless otherwise noted)

Characteristic	Symbol	Min	Typ	Max	Unit
<b>OFF CHARACTERISTICS</b>					
Collector-Base Cutoff Current ( $V_{CB} = 50\text{ V}$ , $I_E = 0$ )	$I_{CBO}$	-	-	100	nAdc
Collector-Emitter Cutoff Current ( $V_{CE} = 50\text{ V}$ , $I_B = 0$ )	$I_{CEO}$	-	-	500	nAdc
Emitter-Base Cutoff Current ( $V_{EB} = 6.0\text{ V}$ , $I_C = 0$ )	$I_{EBO}$	-	-	4.3	mAdc
Collector-Base Breakdown Voltage ( $I_C = 10\ \mu\text{A}$ , $I_E = 0$ )	$V_{(BR)CBO}$	50	-	-	Vdc
Collector-Emitter Breakdown Voltage (Note 5) ( $I_C = 2.0\text{ mA}$ , $I_B = 0$ )	$V_{(BR)CEO}$	50	-	-	Vdc
<b>ON CHARACTERISTICS</b>					
DC Current Gain (Note 5) ( $I_C = 5.0\text{ mA}$ , $V_{CE} = 10\text{ V}$ )	$h_{FE}$	3.0	5.0	-	
Collector-Emitter Saturation Voltage (Note 5) ( $I_C = 10\text{ mA}$ , $I_B = 5.0\text{ mA}$ )	$V_{CE(sat)}$	-	-	0.25	V
Input Voltage (Off) ( $V_{CE} = 5.0\text{ V}$ , $I_C = 100\ \mu\text{A}$ )	$V_{i(off)}$	-	1.2	-	Vdc
Input Voltage (On) ( $V_{CE} = 0.2\text{ V}$ , $I_C = 20\text{ mA}$ )	$V_{i(on)}$	-	1.7	-	Vdc
Output Voltage (On) ( $V_{CC} = 5.0\text{ V}$ , $V_B = 2.5\text{ V}$ , $R_L = 1.0\text{ k}\Omega$ )	$V_{OL}$	-	-	0.2	Vdc
Output Voltage (Off) ( $V_{CC} = 5.0\text{ V}$ , $V_B = 0.05\text{ V}$ , $R_L = 1.0\text{ k}\Omega$ )	$V_{OH}$	4.9	-	-	Vdc
Input Resistor	R1	0.7	1.0	1.3	k $\Omega$
Resistor Ratio	$R_1/R_2$	0.8	1.0	1.2	

Product parametric performance is indicated in the Electrical Characteristics for the listed test conditions, unless otherwise noted. Product performance may not be indicated by the Electrical Characteristics if operated under different conditions.

5. Pulsed Condition: Pulse Width = 300 ms, Duty Cycle  $\leq$  2%.

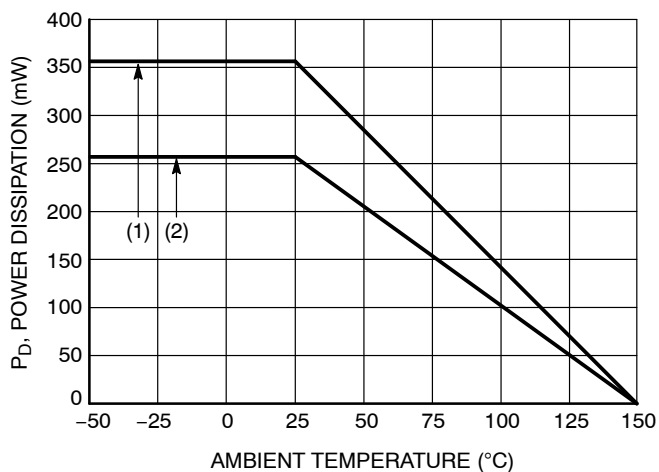

(1) SOT-363; 1.0 x 1.0 Inch Pad  
(2) SOT-563; Minimum Pad

Figure 1. Derating Curve

# MUN5230DW1, NSBC113EDXV6

## TYPICAL CHARACTERISTICS MUN5230DW1, NSBC113EDXV6

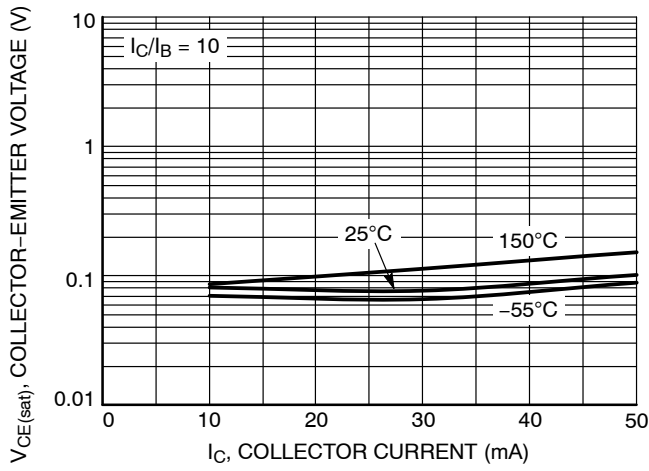

Figure 2.  $V_{CE(sat)}$  vs.  $I_C$

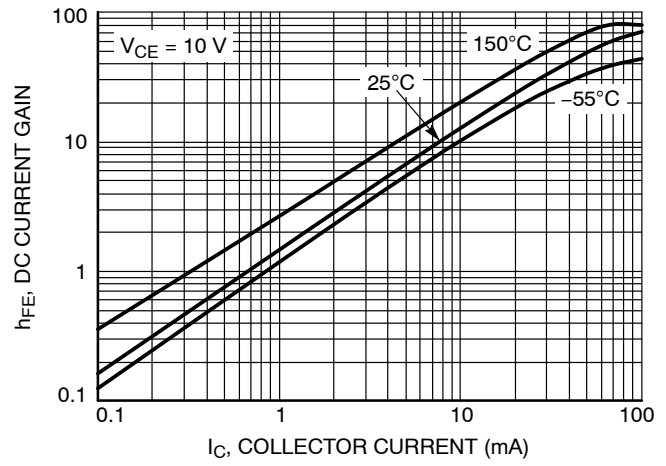

Figure 3. DC Current Gain

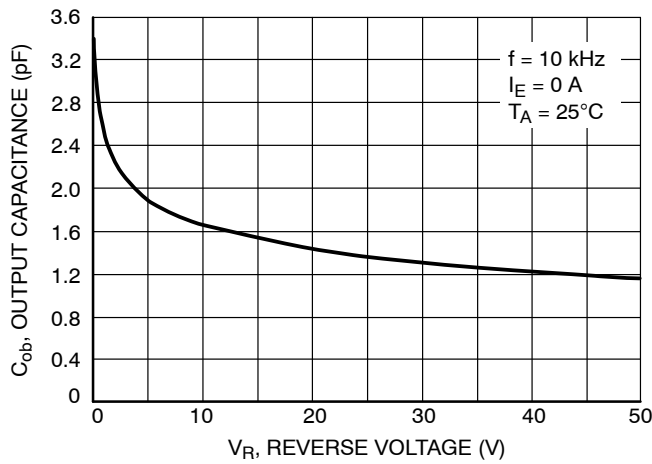

Figure 4. Output Capacitance

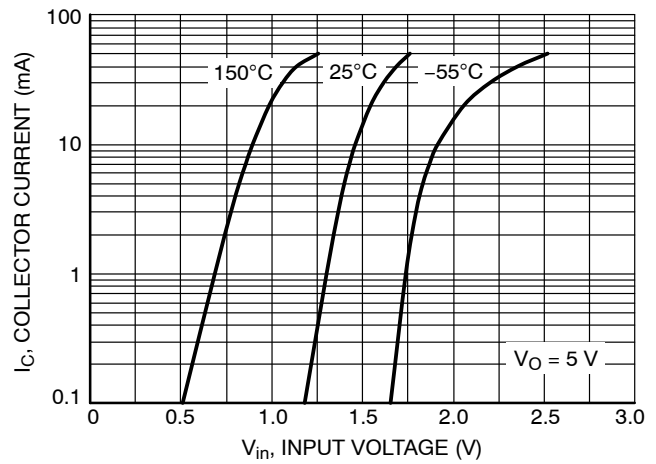

Figure 5. Output Current vs. Input Voltage

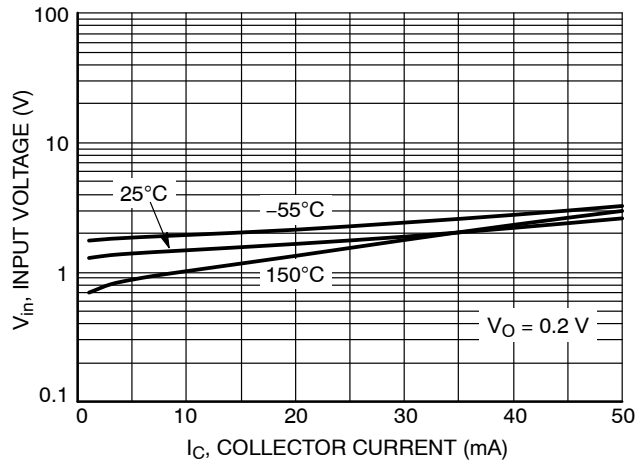

Figure 6. Input Voltage vs. Output Current

# MECHANICAL CASE OUTLINE PACKAGE DIMENSIONS



**SC-88 2.00x1.25x0.90, 0.65P**  
CASE 419B-02  
ISSUE Z

DATE 18 APR 2024

NOTES:

1. DIMENSIONING AND TOLERANCING CONFORM TO ASME Y14.5-2018.
2. ALL DIMENSION ARE IN MILLIMETERS.
3. DIMENSIONS D AND E1 DO NOT INCLUDE MOLD FLASH, PROTRUSIONS, OR GATE BURRS. MOLD FLASH, PROTRUSIONS, OR GATE BURRS SHALL NOT EXCEED 0.20 PER END.
4. DIMENSIONS D AND E1 AT THE OUTERMOST EXTREMES OF THE PLASTIC BODY AND DATUM H.
5. DATUMS A AND B ARE DETERMINED AT DATUM H.
6. DIMENSIONS b AND c APPLY TO THE FLAT SECTION OF THE LEAD BETWEEN 0.08 AND 0.15 FROM THE TIP.
7. DIMENSION b DOES NOT INCLUDE DAMBAR PROTRUSION. ALLOWABLE DAMBAR PROTRUSION SHALL BE 0.08 TOTAL IN EXCESS OF DIMENSION b AT MAXIMUM MATERIAL CONDITION. THE DAMBAR CANNOT BE LOCATED ON THE LOWER RADIUS OF THE FOOT.

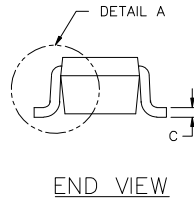
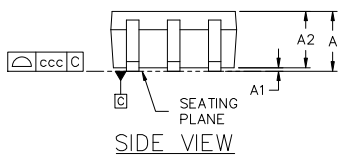
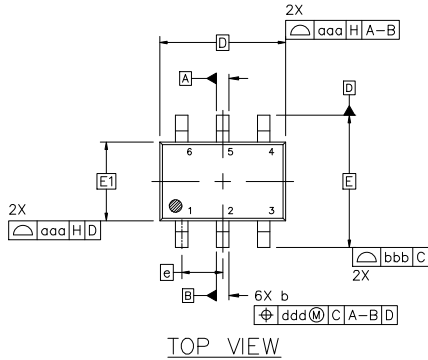

DIM	MILLIMETERS		
	MIN.	NOM.	MAX.
A	---	---	1.10
A1	0.00	---	0.10
A2	0.70	0.90	1.00
b	0.15	0.20	0.25
c	0.08	0.15	0.22
D	2.00 BSC		
E	2.10 BSC		
E1	1.25 BSC		
e	0.65 BSC		
L	0.26	0.36	0.46
L2	0.15 BSC		
aaa	0.15		
bbb	0.30		
ccc	0.10		
ddd	0.10		

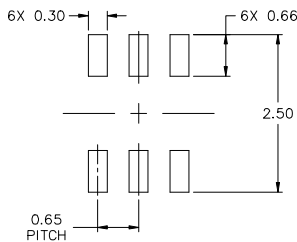

**GENERIC MARKING DIAGRAM\***

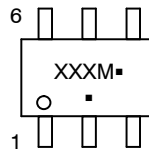

- XXX = Specific Device Code
- M = Date Code\*
- = Pb-Free Package
- = Pb-Free Package

(Note: Microdot may be in either location)  
 \*Date Code orientation and/or position may vary depending upon manufacturing location.  
 \*This information is generic. Please refer to device data sheet for actual part marking. Pb-Free indicator, "G" or microdot "■", may or may not be present. Some products may not follow the Generic Marking.

FOR ADDITIONAL INFORMATION ON OUR Pb-FREE STRATEGY AND SOLDERING DETAILS, PLEASE DOWNLOAD THE ONSEMI SOLDERING AND MOUNTING TECHNIQUES REFERENCE MANUAL, SOLDERRM/D.

**STYLES ON PAGE 2**

<b>DOCUMENT NUMBER:</b>	<b>98ASB42985B</b>	Electronic versions are uncontrolled except when accessed directly from the Document Repository. Printed versions are uncontrolled except when stamped "CONTROLLED COPY" in red.
<b>DESCRIPTION:</b>	<b>SC-88 2.00x1.25x0.90, 0.65P</b>	<b>PAGE 1 OF 2</b>

onsemi and ONSEMI are trademarks of Semiconductor Components Industries, LLC dba onsemi or its subsidiaries in the United States and/or other countries. onsemi reserves the right to make changes without further notice to any products herein. onsemi makes no warranty, representation or guarantee regarding the suitability of its products for any particular purpose, nor does onsemi assume any liability arising out of the application or use of any product or circuit, and specifically disclaims any and all liability, including without limitation special, consequential or incidental damages. onsemi does not convey any license under its patent rights nor the rights of others.

**SC-88 2.00x1.25x0.90, 0.65P**  
**CASE 419B-02**  
**ISSUE Z**

DATE 18 APR 2024

STYLE 1: PIN 1. EMITTER 2 2. BASE 2 3. COLLECTOR 1 4. EMITTER 1 5. BASE 1 6. COLLECTOR 2	STYLE 2: CANCELLED	STYLE 3: CANCELLED	STYLE 4: PIN 1. CATHODE 2. CATHODE 3. COLLECTOR 4. EMITTER 5. BASE 6. ANODE	STYLE 5: PIN 1. ANODE 2. ANODE 3. COLLECTOR 4. EMITTER 5. BASE 6. CATHODE	STYLE 6: PIN 1. ANODE 2 2. N/C 3. CATHODE 1 4. ANODE 1 5. N/C 6. CATHODE 2
STYLE 7: PIN 1. SOURCE 2 2. DRAIN 2 3. GATE 1 4. SOURCE 1 5. DRAIN 1 6. GATE 2	STYLE 8: CANCELLED	STYLE 9: PIN 1. EMITTER 2 2. EMITTER 1 3. COLLECTOR 1 4. BASE 1 5. BASE 2 6. COLLECTOR 2	STYLE 10: PIN 1. SOURCE 2 2. SOURCE 1 3. GATE 1 4. DRAIN 1 5. DRAIN 2 6. GATE 2	STYLE 11: PIN 1. CATHODE 2 2. CATHODE 2 3. ANODE 1 4. CATHODE 1 5. CATHODE 1 6. ANODE 2	STYLE 12: PIN 1. ANODE 2 2. ANODE 2 3. CATHODE 1 4. ANODE 1 5. ANODE 1 6. CATHODE 2
STYLE 13: PIN 1. ANODE 2. N/C 3. COLLECTOR 4. EMITTER 5. BASE 6. CATHODE	STYLE 14: PIN 1. VREF 2. GND 3. GND 4. IOUT 5. VEN 6. VCC	STYLE 15: PIN 1. ANODE 1 2. ANODE 2 3. ANODE 3 4. CATHODE 3 5. CATHODE 2 6. CATHODE 1	STYLE 16: PIN 1. BASE 1 2. EMITTER 2 3. COLLECTOR 2 4. BASE 2 5. EMITTER 1 6. COLLECTOR 1	STYLE 17: PIN 1. BASE 1 2. EMITTER 1 3. COLLECTOR 2 4. BASE 2 5. EMITTER 2 6. COLLECTOR 1	STYLE 18: PIN 1. VIN1 2. VCC 3. VOUT2 4. VIN2 5. GND 6. VOUT1
STYLE 19: PIN 1. IOUT 2. GND 3. GND 4. V CC 5. V EN 6. V REF	STYLE 20: PIN 1. COLLECTOR 2. COLLECTOR 3. BASE 4. EMITTER 5. COLLECTOR 6. COLLECTOR	STYLE 21: PIN 1. ANODE 1 2. N/C 3. ANODE 2 4. CATHODE 2 5. N/C 6. CATHODE 1	STYLE 22: PIN 1. D1 (i) 2. GND 3. D2 (i) 4. D2 (c) 5. VBUS 6. D1 (c)	STYLE 23: PIN 1. Vn 2. CH1 3. Vp 4. N/C 5. CH2 6. N/C	STYLE 24: PIN 1. CATHODE 2. ANODE 3. CATHODE 4. CATHODE 5. CATHODE 6. CATHODE
STYLE 25: PIN 1. BASE 1 2. CATHODE 3. COLLECTOR 2 4. BASE 2 5. EMITTER 6. COLLECTOR 1	STYLE 26: PIN 1. SOURCE 1 2. GATE 1 3. DRAIN 2 4. SOURCE 2 5. GATE 2 6. DRAIN 1	STYLE 27: PIN 1. BASE 2 2. BASE 1 3. COLLECTOR 1 4. EMITTER 1 5. EMITTER 2 6. COLLECTOR 2	STYLE 28: PIN 1. DRAIN 2. DRAIN 3. GATE 4. SOURCE 5. DRAIN 6. DRAIN	STYLE 29: PIN 1. ANODE 2. ANODE 3. COLLECTOR 4. EMITTER 5. BASE/ANODE 6. CATHODE	STYLE 30: PIN 1. SOURCE 1 2. DRAIN 2 3. DRAIN 2 4. SOURCE 2 5. GATE 1 6. DRAIN 1

Note: Please refer to datasheet for style callout. If style type is not called out in the datasheet refer to the device datasheet pinout or pin assignment.

<b>DOCUMENT NUMBER:</b>	<b>98ASB42985B</b>	Electronic versions are uncontrolled except when accessed directly from the Document Repository. Printed versions are uncontrolled except when stamped "CONTROLLED COPY" in red.
<b>DESCRIPTION:</b>	<b>SC-88 2.00x1.25x0.90, 0.65P</b>	<b>PAGE 2 OF 2</b>

**onsemi** and **ONSEMI** are trademarks of Semiconductor Components Industries, LLC dba **onsemi** or its subsidiaries in the United States and/or other countries. **onsemi** reserves the right to make changes without further notice to any products herein. **onsemi** makes no warranty, representation or guarantee regarding the suitability of its products for any particular purpose, nor does **onsemi** assume any liability arising out of the application or use of any product or circuit, and specifically disclaims any and all liability, including without limitation special, consequential or incidental damages. **onsemi** does not convey any license under its patent rights nor the rights of others.

# MECHANICAL CASE OUTLINE

## PACKAGE DIMENSIONS



**SOT-563-6 1.60x1.20x0.55, 0.50P**  
**CASE 463A**  
**ISSUE J**

DATE 15 FEB 2024

**NOTES:**

1. DIMENSIONING AND TOLERANCING CONFORM TO ASME Y14.5-2018.
2. ALL DIMENSION ARE IN MILLIMETERS.
3. MAXIMUM LEAD THICKNESS INCLUDES LEAD FINISH THICKNESS. MINIMUM LEAD THICKNESS IS THE MINIMUM THICKNESS OF BASE MATERIAL.

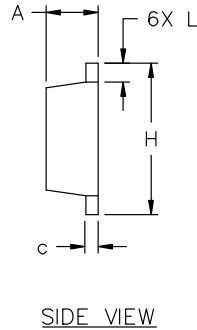
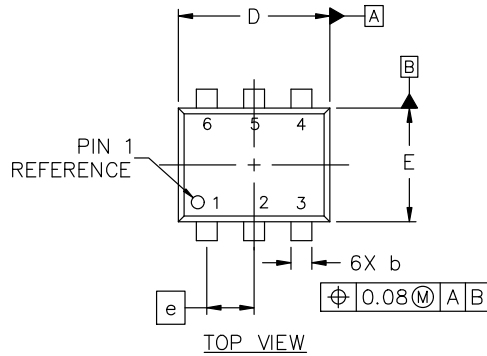

DIM	MILLIMETERS		
	MIN.	NOM.	MAX.
A	0.50	0.55	0.60
b	0.17	0.22	0.27
c	0.08	0.13	0.18
D	1.50	1.60	1.70
E	1.10	1.20	1.30
e	0.50 BSC		
H	1.50	1.60	1.70
L	0.10	0.20	0.30

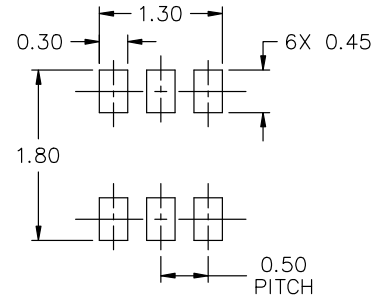

- |  |   |  |
|--|---|--|
| <p><b>STYLE 1:</b><br/>         PIN 1. EMITTER 1<br/>         2. BASE 1<br/>         3. COLLECTOR 2<br/>         4. EMITTER 2<br/>         5. BASE 2<br/>         6. COLLECTOR 1</p> | <p><b>STYLE 2:</b><br/>         PIN 1. EMITTER 1<br/>         2. EMITTER 2<br/>         3. BASE 2<br/>         4. COLLECTOR 2<br/>         5. BASE 1<br/>         6. COLLECTOR 1</p>  | <p><b>STYLE 3:</b><br/>         PIN 1. CATHODE 1<br/>         2. CATHODE 1<br/>         3. ANODE/ANODE 2<br/>         4. CATHODE 2<br/>         5. CATHODE 2<br/>         6. ANODE/ANODE 1</p> |
| <p><b>STYLE 4:</b><br/>         PIN 1. COLLECTOR<br/>         2. COLLECTOR<br/>         3. BASE<br/>         4. EMITTER<br/>         5. COLLECTOR<br/>         6. COLLECTOR</p>      | <p><b>STYLE 5:</b><br/>         PIN 1. CATHODE<br/>         2. CATHODE<br/>         3. ANODE<br/>         4. ANODE<br/>         5. CATHODE<br/>         6. CATHODE</p>                | <p><b>STYLE 6:</b><br/>         PIN 1. CATHODE<br/>         2. ANODE<br/>         3. CATHODE<br/>         4. CATHODE<br/>         5. CATHODE<br/>         6. CATHODE</p>                       |
| <p><b>STYLE 7:</b><br/>         PIN 1. CATHODE<br/>         2. ANODE<br/>         3. CATHODE<br/>         4. CATHODE<br/>         5. ANODE<br/>         6. CATHODE</p>               | <p><b>STYLE 8:</b><br/>         PIN 1. DRAIN<br/>         2. DRAIN<br/>         3. GATE<br/>         4. SOURCE<br/>         5. DRAIN<br/>         6. DRAIN</p>                        | <p><b>STYLE 9:</b><br/>         PIN 1. SOURCE 1<br/>         2. GATE 1<br/>         3. DRAIN 2<br/>         4. SOURCE 2<br/>         5. GATE 2<br/>         6. DRAIN 1</p>                     |
| <p><b>STYLE 10:</b><br/>         PIN 1. CATHODE 1<br/>         2. N/C<br/>         3. CATHODE 2<br/>         4. ANODE 2<br/>         5. N/C<br/>         6. ANODE 1</p>              | <p><b>STYLE 11:</b><br/>         PIN 1. EMITTER 2<br/>         2. BASE 2<br/>         3. COLLECTOR 1<br/>         4. EMITTER 1<br/>         5. BASE 1<br/>         6. COLLECTOR 2</p> |  |

\* FOR ADDITIONAL INFORMATION ON OUR Pb-FREE STRATEGY AND SOLDERING DETAILS, PLEASE DOWNLOAD THE ON SEMICONDUCTOR SOLDERING AND MOUNTING TECHNIQUES REFERENCE MANUAL, SOLDERRM/D.

**GENERIC MARKING DIAGRAM\***

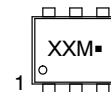

- XX = Specific Device Code
- M = Month Code
- = Pb-Free Package

\*This information is generic. Please refer to device data sheet for actual part marking. Pb-Free indicator, "G" or microdot "•", may or may not be present. Some products may not follow the Generic Marking.

<b>DOCUMENT NUMBER:</b>	<b>98AON11126D</b>	Electronic versions are uncontrolled except when accessed directly from the Document Repository. Printed versions are uncontrolled except when stamped "CONTROLLED COPY" in red.
<b>DESCRIPTION:</b>	<b>SOT-563-6 1.60x1.20x0.55, 0.50P</b>	<b>PAGE 1 OF 1</b>

onsemi and ONSEMI are trademarks of Semiconductor Components Industries, LLC dba onsemi or its subsidiaries in the United States and/or other countries. onsemi reserves the right to make changes without further notice to any products herein. onsemi makes no warranty, representation or guarantee regarding the suitability of its products for any particular purpose, nor does onsemi assume any liability arising out of the application or use of any product or circuit, and specifically disclaims any and all liability, including without limitation special, consequential or incidental damages. onsemi does not convey any license under its patent rights nor the rights of others.

**onsemi**, **Onsemi**, and other names, marks, and brands are registered and/or common law trademarks of Semiconductor Components Industries, LLC dba "**onsemi**" or its affiliates and/or subsidiaries in the United States and/or other countries. **onsemi** owns the rights to a number of patents, trademarks, copyrights, trade secrets, and other intellectual property. A listing of **onsemi**'s product/patent coverage may be accessed at [www.onsemi.com/site/pdf/Patent-Marking.pdf](http://www.onsemi.com/site/pdf/Patent-Marking.pdf). **onsemi** reserves the right to make changes at any time to any products or information herein, without notice. The information herein is provided "as-is" and **onsemi** makes no warranty, representation or guarantee regarding the accuracy of the information, product features, availability, functionality, or suitability of its products for any particular purpose, nor does **onsemi** assume any liability arising out of the application or use of any product or circuit, and specifically disclaims any and all liability, including without limitation special, consequential or incidental damages. Buyer is responsible for its products and applications using **onsemi** products, including compliance with all laws, regulations and safety requirements or standards, regardless of any support or applications information provided by **onsemi**. "Typical" parameters which may be provided in **onsemi** data sheets and/or specifications can and do vary in different applications and actual performance may vary over time. All operating parameters, including "Typicals" must be validated for each customer application by customer's technical experts. **onsemi** does not convey any license under any of its intellectual property rights nor the rights of others. **onsemi** products are not designed, intended, or authorized for use as a critical component in life support systems or any FDA Class 3 medical devices or medical devices with a same or similar classification in a foreign jurisdiction or any devices intended for implantation in the human body. Should Buyer purchase or use **onsemi** products for any such unintended or unauthorized application, Buyer shall indemnify and hold **onsemi** and its officers, employees, subsidiaries, affiliates, and distributors harmless against all claims, costs, damages, and expenses, and reasonable attorney fees arising out of, directly or indirectly, any claim of personal injury or death associated with such unintended or unauthorized use, even if such claim alleges that **onsemi** was negligent regarding the design or manufacture of the part. **onsemi** is an Equal Opportunity/Affirmative Action Employer. This literature is subject to all applicable copyright laws and is not for resale in any manner.

## ADDITIONAL INFORMATION

### TECHNICAL PUBLICATIONS:

Technical Library: [www.onsemi.com/design/resources/technical-documentation](http://www.onsemi.com/design/resources/technical-documentation)  
onsemi Website: [www.onsemi.com](http://www.onsemi.com)

### ONLINE SUPPORT: [www.onsemi.com/support](http://www.onsemi.com/support)

For additional information, please contact your local Sales Representative at [www.onsemi.com/support/sales](http://www.onsemi.com/support/sales)