

Enhanced Voltage Mode PWM Controller

CS51221

The CS51221 fixed frequency feed forward voltage mode PWM controller contains all of the features necessary for basic voltage mode operation. This PWM controller has been optimized for high frequency primary side control operation. In addition, this device includes such features as: Soft-Start, accurate duty cycle limit control, less than 50 μ A startup current, over and undervoltage protection, and bidirectional synchronization. The CS51221 is available in a 16 lead SOIC narrow surface mount package.

Features

- 1.0 MHz Frequency Capability
- Fixed Frequency Voltage Mode Operation, with Feed Forward
- Thermal Shutdown
- Undervoltage Lock-Out
- Accurate Programmable Max Duty Cycle Limit
- 1.0 A Sink/Source Gate Drive
- Programmable Pulse-By-Pulse Overcurrent Protection
- Leading Edge Current Sense Blanking
- 75 ns Shutdown Propagation Delay
- Programmable Soft-Start
- Undervoltage Protection
- Overvoltage Protection with Programmable Hysteresis
- Bidirectional Synchronization
- 25 ns GATE Rise and Fall Time (1.0 nF Load)
- 3.3 V 3% Reference Voltage Output
- These Devices are Pb-Free and are RoHS Compliant

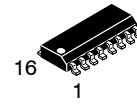

SOIC-16
 D SUFFIX
 CASE 751B-05

PIN CONNECTIONS AND MARKING DIAGRAM

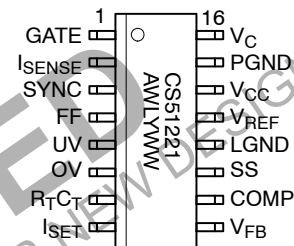

- x = Specific Device Code
- A = Assembly Location
- WL = Wafer Lot
- Y = Year
- WW = Work Week
- G = Pb-Free Package

ORDERING INFORMATION

See detailed ordering and shipping information in the package dimensions section on page 12 of this data sheet.

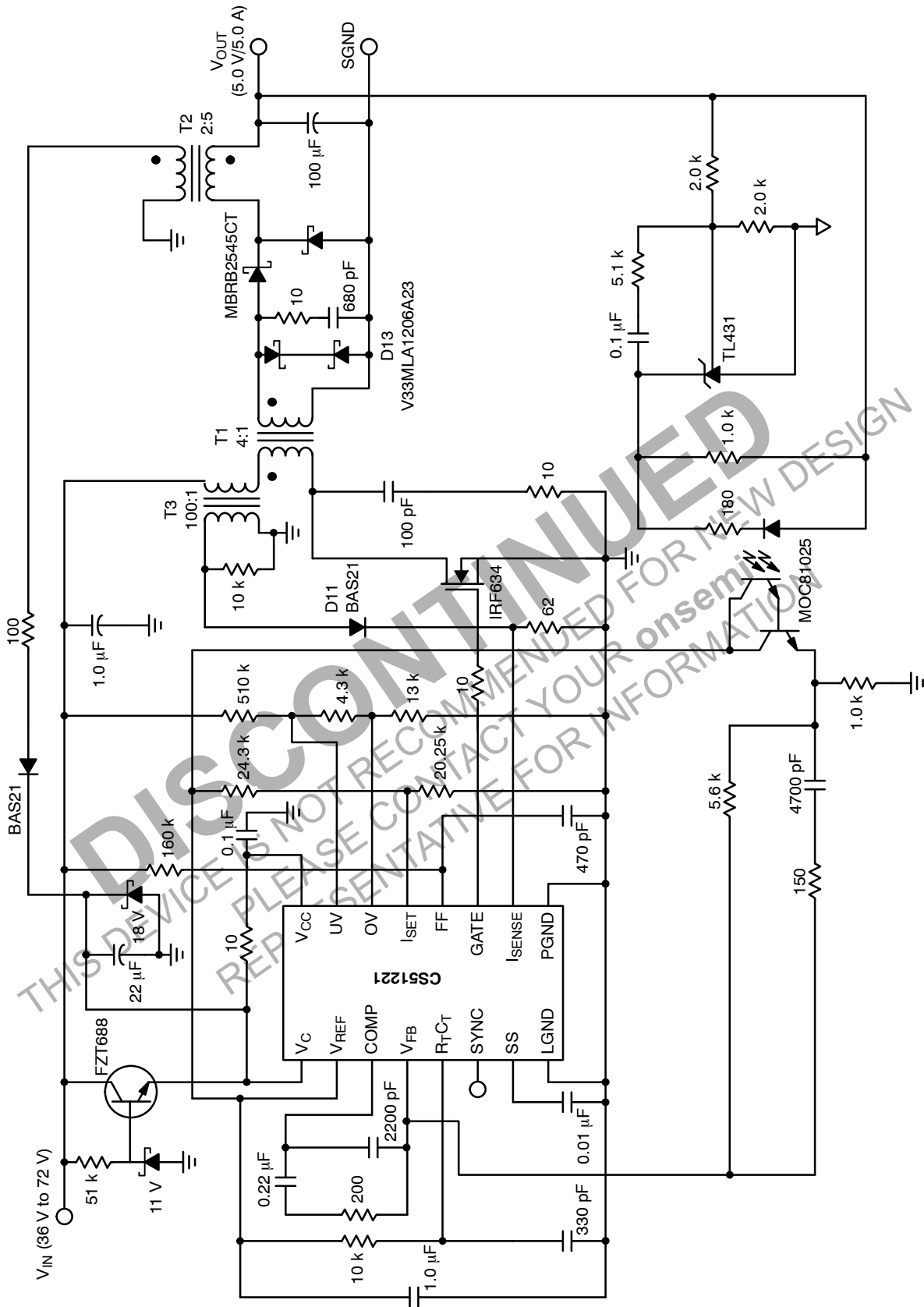

Figure 1. Application Diagram, 36 V–72 V to 5.0 V/5.0 A Converter

MAXIMUM RATINGS

Rating	Value	Unit
Operating Junction Temperature, T_J	Internally Limited	–
Lead Temperature Soldering: Reflow: (SMD styles only) (Note 1)	230 peak	°C
Storage Temperature Range, T_S	–65 to +150	°C
ESD (Human Body Model)	2.0	kV

Maximum ratings are those values beyond which device damage can occur. Maximum ratings applied to the device are individual stress limit values (not normal operating conditions) and are not valid simultaneously. If these limits are exceeded, device functional operation is not implied, damage may occur and reliability may be affected.

1. 60 second maximum above 183°C.

MAXIMUM RATINGS

Pin Name	Pin Symbol	V_{MAX}	V_{MIN}	I_{SOURCE}	I_{SINK}
Gate Drive Output	GATE	15 V	–0.3 V	1.0 A Peak, 200 mA DC	1.0 A Peak, 200 mA DC
Current Sense Input	I_{SENSE}	6.0 V	–0.3 V	1.0 mA	1.0 mA
Timing Resistor/Capacitor	$R_T C_T$	6.0 V	–0.3 V	1.0 mA	10 mA
Feed Forward	FF	6.0 V	–0.3 V	1.0 mA	25 mA
Error Amp Output	COMP	6.0 V	–0.3 V	10 mA	20 mA
Feedback Voltage	V_{FB}	6.0 V	–0.3 V	1.0 mA	1.0 mA
Sync Input	SYNC	6.0 V	–0.3 V	10 mA	10 mA
Undervoltage	UV	6.0 V	–0.3 V	1.0 mA	1.0 mA
Overshoot	OV	6.0 V	–0.3 V	1.0 mA	1.0 mA
Current Set	I_{SET}	6.0 V	–0.3 V	1.0 mA	1.0 mA
Soft-Start	SS	6.0 V	–0.3 V	1.0 mA	10 mA
Logic Section Supply	V_{CC}	15 V	–0.3 V	10 mA	50 mA
Power Section Supply	V_C	15 V	–0.3 V	10 mA	1.0 A Peak, 200 mA DC
Reference Voltage	V_{REF}	6.0 V	–0.3 V	Internally Limited	10 mA
Power Ground	PGND	N/A	N/A	1.0 A Peak, 200 mA DC	N/A
Logic Ground	LGND	N/A	N/A	N/A	N/A

ELECTRICAL CHARACTERISTICS ($-40^{\circ}\text{C} < T_A < 85^{\circ}\text{C}$; $-40^{\circ}\text{C} < T_J < 125^{\circ}\text{C}$; $3.0\text{ V} < V_C < 15\text{ V}$; $4.7\text{ V} < V_{CC} < 15\text{ V}$;
 $R_T = 12\text{ k}$; $C_T = 390\text{ pF}$; unless otherwise specified.)

Characteristic	Test Conditions	Min	Typ	Max	Unit
----------------	-----------------	-----	-----	-----	------

Start/Stop Voltages

Start Threshold	–	4.4	4.6	4.7	V
Stop Threshold	–	3.2	3.8	4.1	V
Hysteresis	Start–Stop	400	850	1400	mV
I_{CC} @ Startup	$V_{CC} < UV_L$ Start Threshold	–	38	75	μA

Supply Current

I_{CC} Operating	–	–	9.5	14	mA
I_C Operating	1.0 nF Load on GATE	–	12	18	mA
I_C Operating	No Switching	–	2.0	4.0	mA

CS51221

ELECTRICAL CHARACTERISTICS ($-40^{\circ}\text{C} < T_A < 85^{\circ}\text{C}$; $-40^{\circ}\text{C} < T_J < 125^{\circ}\text{C}$; $3.0\text{ V} < V_C < 15\text{ V}$; $4.7\text{ V} < V_{CC} < 15\text{ V}$;
 $R_T = 12\text{ k}$; $C_T = 390\text{ pF}$; unless otherwise specified.)

Characteristic	Test Conditions	Min	Typ	Max	Unit
Reference Voltage					
Total Accuracy	$0\text{ mA} < I_{REF} < 2.0\text{ mA}$	3.2	3.3	3.4	V
Line Regulation	-	-	6.0	20	mV
Load Regulation	$0\text{ mA} < I_{REF} < 2.0\text{ mA}$	-	6.0	15	mV
Noise Voltage	$10\text{ Hz} < F < 10\text{ kHz}$. Note 2	-	50	-	μV
Op Life Shift	$T = 1000\text{ Hrs}$. Note 2	-	4.0	20	mV
Fault Voltage	-	2.8	2.95	3.1	V
$V_{REF(OK)}$ Voltage	-	2.9	3.05	3.2	V
$V_{REF(OK)}$ Hysteresis	-	30	100	150	mV
Current Limit	-	2.0	40	100	mA

Error Amp

Reference Voltage	$V_{FB} = \text{COMP}$	1.234	1.263	1.285	V
V_{FB} Input Current	$V_{FB} = 1.2\text{ V}$	-	1.3	2.0	μA
Open Loop Gain	Note 2	60	-	-	dB
Unity Gain Bandwidth	Note 2	1.5	-	-	MHz
COMP Sink Current	$\text{COMP} = 1.4\text{ V}$, $V_{FB} = 1.45\text{ V}$	3.0	12	32	mA
COMP Source Current	$\text{COMP} = 1.4\text{ V}$, $V_{FB} = 1.15\text{ V}$	1.0	1.6	2.0	mA
COMP High Voltage	$V_{FB} = 1.15\text{ V}$	2.8	3.1	3.4	V
COMP Low Voltage	$V_{FB} = 1.45\text{ V}$	75	125	300	mV
PSRR	Freq = 120 Hz. Note 2	60	85	-	dB
SS Clamp, V_{COMP}	$\text{SS} = 1.4\text{ V}$, $V_{FB} = 0\text{ V}$, $I_{SET} = 2.0\text{ V}$	1.3	1.4	1.5	V
COMP Max Clamp	Note 2	1.7	1.8	1.9	V

Oscillator

Frequency Accuracy		260	273	320	kHz
Voltage Stability	-	-	1.0	2.0	%
Temperature Stability	$-40^{\circ}\text{C} < T_J < 125^{\circ}\text{C}$. (Note 2)	-	8.0	-	%
Max Frequency	Note 2	1.0	-	-	MHz
Duty Cycle	-	80	85	90	%
Peak Voltage	Note 2	1.94	2.0	2.06	V
Valley Clamp Voltage	-	0.9	0.95	1.0	V
Valley Voltage	Note 2	0.85	1.0	1.15	V
Discharge Current	-	0.85	1.0	1.15	mA

Synchronization

Input Threshold	-	0.9	1.4	1.8	V
Output Pulse Width	-	200	320	450	ns
Output High Voltage	100 μA Load	2.1	2.5	2.8	V
Input Resistance	-	35	70	140	$\text{k}\Omega$
SYNC to Drive Delay	Time from SYNC to GATE Shutdown	100	140	180	ns
Output Drive Current	$R_{SYNC} = 1.0\ \Omega$	1.0	1.5	2.25	mA

2. Guaranteed by design, not 100% tested in production.

CS51221

ELECTRICAL CHARACTERISTICS ($-40^{\circ}\text{C} < T_A < 85^{\circ}\text{C}$; $-40^{\circ}\text{C} < T_J < 125^{\circ}\text{C}$; $3.0\text{ V} < V_C < 15\text{ V}$; $4.7\text{ V} < V_{CC} < 15\text{ V}$;
 $R_T = 12\text{ k}$; $C_T = 390\text{ pF}$; unless otherwise specified.)

Characteristic	Test Conditions	Min	Typ	Max	Unit
----------------	-----------------	-----	-----	-----	------

Gate Driver

High Saturation Voltage	$V_C - \text{GATE}$, $V_C = 10\text{ V}$, $I_{\text{SOURCE}} = 200\text{ mA}$	-	1.5	2.0	V
Low Saturation Voltage	$\text{GATE} - \text{PGND}$, $I_{\text{SINK}} = 200\text{ mA}$	-	1.2	1.5	V
High Voltage Clamp	-	11	13.5	16	V
Output Current	1.0 nF Load. Note 3	-	1.0	1.25	A
Output UVL Leakage	$\text{GATE} = 0\text{ V}$	-	1.0	50	μA
Rise Time	1.0 nF Load, $V_C = 20\text{ V}$, $1.0\text{ V} < \text{GATE} < 9.0\text{ V}$	-	60	100	ns
Fall Time	1.0 nF Load, $V_C = 20\text{ V}$, $9.0\text{ V} < \text{GATE} < 1.0\text{ V}$	-	25	50	ns
Max Gate Voltage During UVL/Sleep	$I_{\text{GATE}} = 500\text{ }\mu\text{A}$	0.4	0.7	1.0	V

Feed Forward (FF)

Discharge Voltage	$I_{\text{FF}} = 2.0\text{ mA}$	-	0.3	0.7	V
Discharge Current	$\text{FF} = 1.0\text{ V}$	2.0	16	30	mA
FF to GATE Delay	-	50	75	125	ns

Overcurrent Protection

Overcurrent Threshold	$I_{\text{SET}} = 0.5\text{ V}$, Ramp I_{SENSE}	0.475	0.5	0.525	V
I_{SENSE} to GATE Delay	-	50	90	125	ns

External Voltage Monitors

Overvoltage Threshold	OV Increasing	1.9	2.0	2.1	V
Overvoltage Hysteresis Current	$\text{OV} = 2.15\text{ V}$	10	12.5	15	μA
Undervoltage Threshold	UV Increasing	0.95	1.0	1.05	V
Undervoltage Hysteresis	-	25	75	125	mV

Soft-Start (SS)

Charge Current	$\text{SS} = 2.0\text{ V}$	40	50	70	μA
Discharge Current	$\text{SS} = 2.0\text{ V}$	4.0	5.0	7.0	μA
Charge Voltage	-	2.8	3.0	3.4	V
Discharge Voltage	-	0.25	0.3	0.35	V
Soft-Start Clamp Offset	$\text{FF} = 1.25\text{ V}$	1.15	1.25	1.35	V
Soft-Start Fault Voltage	$\text{OV} = 2.15\text{ V}$ or $\text{LV} = 0.85\text{ V}$	-	0.1	0.2	V

Blanking

Blanking Time	-	50	150	250	ns
SS Blanking Disable Threshold	$V_{\text{FB}} < 1.0$	2.8	3.0	3.3	V
COMP Blanking Disable Threshold	$V_{\text{FB}} < 1.0$, $\text{SS} > 3.0\text{ V}$	2.8	3.0	3.3	V

Thermal Shutdown

Thermal Shutdown	Note 3	125	150	180	$^{\circ}\text{C}$
Thermal Hysteresis	Note 3	5.0	10	15	$^{\circ}\text{C}$

3. Guaranteed by design, not 100% tested in production.

PACKAGE PIN DESCRIPTION

Package Pin #	Pin Symbol	Function
1	GATE	External power switch driver with 1.0 A peak capability. Rail to rail output occurs when the capacitive load is between 470 pF and 10 nF.
2	I _{SENSE}	Current sense comparator input.
3	SYNC	Bidirectional synchronization. Locks to highest frequency.
4	FF	PWM ramp.
5	UV	Undervoltage protection monitor.
6	OV	Overvoltage protection monitor.
7	R _T C _T	Timing resistor R _T and capacitor C _T determine oscillator frequency and maximum duty cycle, D _{MAX} .
8	I _{SET}	Voltage at this pin sets pulse-by-pulse overcurrent threshold.
9	V _{FB}	Feedback voltage input. Connected to the error amplifier inverting input.
10	COMP	Error amplifier output.
11	SS	Charging external capacitor restricts error amplifier output voltage during the power up or fault conditions.
12	LGND	Logic ground.
13	V _{REF}	3.3 V reference voltage output. Decoupling capacitor can be selected from 0.01- μ F to 10 μ F.
14	V _{CC}	Logic supply voltage.
15	PGND	Output power stage ground.
16	V _C	Output power stage supply voltage.

DISCONTINUED
 THIS DEVICE IS NOT RECOMMENDED FOR NEW DESIGN
 PLEASE CONTACT YOUR onsemi
 REPRESENTATIVE FOR INFORMATION

CS51221

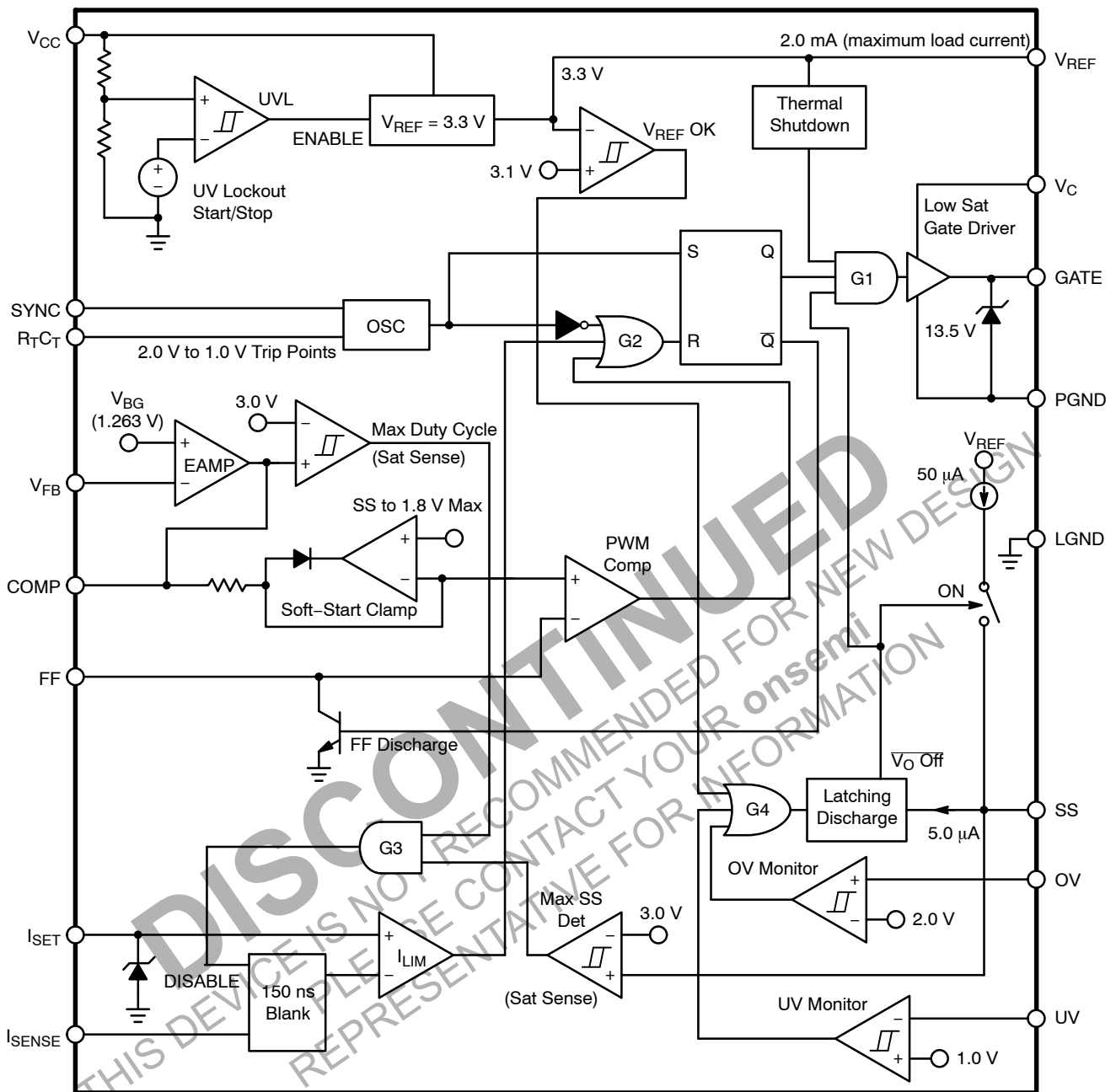

Figure 2. Block Diagram

APPLICATION INFORMATION

THEORY OF OPERATION

Feed Forward Voltage Mode Control

In conventional voltage mode control, the ramp signal has fixed rising and falling slope. The feedback signal is derived solely from the output voltage. Consequently, voltage mode control has inferior line regulation and audio susceptibility.

Feed forward voltage mode control derives the ramp signal from the input line, as shown in Figure 3. Therefore, the ramp of the slope varies with the input voltage. At the start of each switch cycle, the capacitor connected to the FF pin is charged through a resistor connected to the input voltage. Meanwhile, the Gate output is turned on to drive an external power switching device. When the FF pin voltage reaches the error amplifier output V_{COMP} , the PWM comparator turns off the Gate, which in turn opens the external switch. Simultaneously, the FF capacitor is quickly discharged to 0.3 V.

Overall, the dynamics of the duty cycle are controlled by both input and output voltages. As illustrated in Figure 4, with a fixed input voltage the output voltage is regulated solely by the error amplifier. For example, an elevated output voltage reduces V_{COMP} which in turn causes duty cycle to decrease. However, if the input voltage varies, the slope of the ramp signal will react immediately which provides a much improved line transient response. As an example shown in Figure 5, when the input voltage goes up, the rising edge of the ramp signal increases which reduces duty cycle to counteract the change.

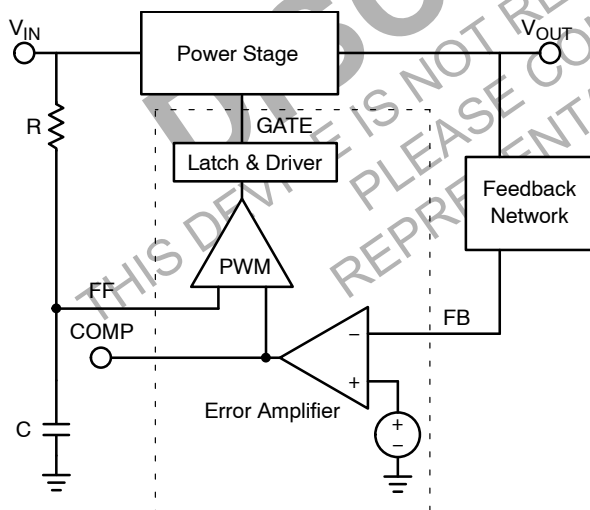

Figure 3. Feed Forward Voltage Mode Control

The feed forward feature can also be employed to provide a volt-second clamp, which limits the maximum product of input voltage and turn on time. This clamp is used in circuits, such as Forward and Flyback converter, to prevent the transformer from saturating. Calculations used in the design of the volt-second clamp are presented in the Design Guidelines section.

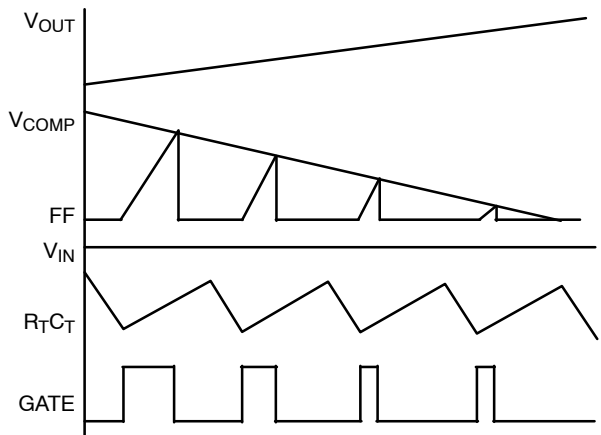

Figure 4. Pulse Width Modulated by Output Current with Constant Input Voltage

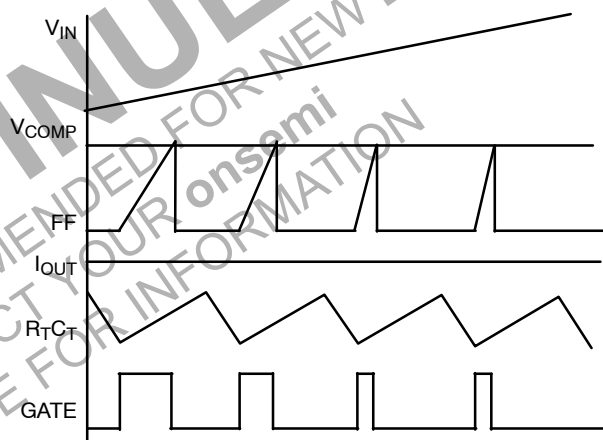

Figure 5. Pulse Width Modulated by Input Voltage with Constant Output Current

Powering the IC & UVL

The Undervoltage Lockout (UVL) comparator has two voltage references; the start and stop thresholds. During power-up, the UVL comparator disables V_{REF} (which in-turn disables the entire IC) until the controller reaches its V_{CC} start threshold. During power-down, the UVL comparator allows the controller to operate until the V_{CC} stop threshold is reached. The CS51221 requires only 50 μ A during startup. The output stage is held at a low impedance state in lock out mode.

During power up and fault conditions, the Soft-Start clamps the Comp pin voltage and limits the duty cycle. The power up transition tends to generate temporary duty cycles much greater than the steady state value due to the low output voltage. Consequently, excessive current stresses often take place in the system. Soft-Start technique alleviates this problem by gradually releasing the clamp on the duty cycle to eliminate the in-rush current. The duration

of the Soft-Start can be programmed through a capacitance connected to the SS pin. The constant charging current to the SS pin is 50 μA (typ).

The V_{REF} (ok) comparator monitors the 3.3 V V_{REF} output and latches a fault condition if V_{REF} falls below 3.1 V. The fault condition may also be triggered when the OV pin voltage rises above 2.0 V or the UV pin voltage falls below 1.0 V. The undervoltage comparator has a built-in hysteresis of 75 mV (typ). The hysteresis for the OV comparator is programmable through a resistor connected to the OV pin. When an OV condition is detected, the overvoltage hysteresis current of 12.5 μA (typ) is sourced from the pin.

In Figure 6, the fault condition is triggered by pulling the UV pin to the ground. Immediately, the SS capacitor is discharged with 5.0 μA of current (typ) and the GATE output is disabled until the SS voltage reaches the discharge voltage of 0.3 V (typ). The IC starts the Soft-Start transition again if the fault condition has recovered as shown in Figure 6. However, if the fault condition persists, the SS voltage will stay at 0.1 V until the removal of the fault condition.

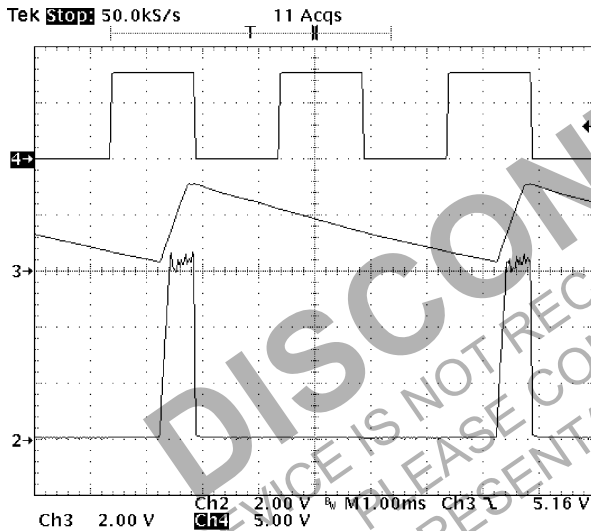

Figure 6. The Fault Condition Is Triggered when the UV Pin Voltage Falls Below 1.0 V. The Soft-Start Capacitor Is Discharged and the GATE Output Is Disabled. CH2: Envelop of GATE Output, CH3: SS Pin with 0.01 μF Capacitor, CH4: UV Pin

Current Sense and Overcurrent Protection

The current can be monitored by the I_{SENSE} pin to achieve pulse by pulse current limit. Various techniques, such as a using current sense resistor or current transformer, can be adopted to derive current signals. The voltage of the I_{SET} pin sets the threshold for maximum current. As shown in Figure 7, when the I_{SENSE} pin voltage exceeds the I_{SET} voltage, the current limit comparator will reset the GATE latch flip-flop to terminate the GATE pulse.

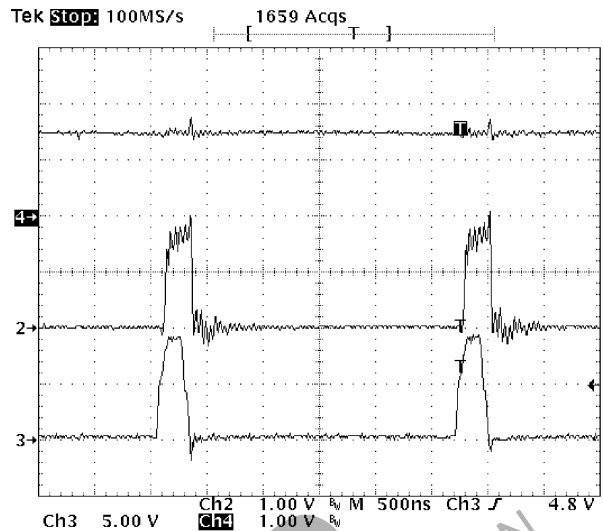

Figure 7. The GATE Output Is Terminated When the I_{SENSE} Pin Voltage Reaches the Threshold Set By the I_{SET} Pin. CH2: I_{SENSE} Pin, CH4: I_{SET} Pin, CH3: GATE Pin

The current sense signal is prone to leading edge spikes caused by the switching transition. A RC low-pass filter is usually applied to the current signals to avoid premature triggering. However, the low pass filter will inevitably change the shape of the current pulse and also add cost. The CS51221 uses leading edge blanking circuitry that blocks out the first 150 ns (typ) of each current pulse. This removes the leading edge spikes without altering the current waveform. The blanking is disabled during Soft-Start and when the V_{COMP} is saturated high so that the minimum on-time of the controller does not have the additional blanking period. The max SS detect comparator keeps the blanking function disabled until SS charges fully. The output of the max Duty Cycle detector goes high when the error amplifier output gets saturated high, indicating that the output voltage has fallen well below its regulation point and the power supply may be underload stress.

Oscillator and Synchronization

The switching frequency is programmable through a RC network connected to the $R_{\text{TC}}T$ Pin. As shown in Figure 8, when the $R_{\text{TC}}T$ pin reaches 2.0 V, the capacitor is discharged by a 1.0 mA current source and the Gate signal is disabled. When the $R_{\text{TC}}T$ pin decreases to 1.0 V, the Gate output is turned on and the discharge current is removed to let the $R_{\text{TC}}T$ pin ramp up. This begins a new switching cycle. The C_{T} charging time over the switch period sets the maximum duty cycle clamp which is programmable through the R_{T} value as shown in the Design Guidelines. At the beginning of each switching cycle, the SYNC pin generates a 2.5 V, 320 ns (typ) pulse. This pulse can be utilized to synchronize other power supplies.

DESIGN GUIDELINES

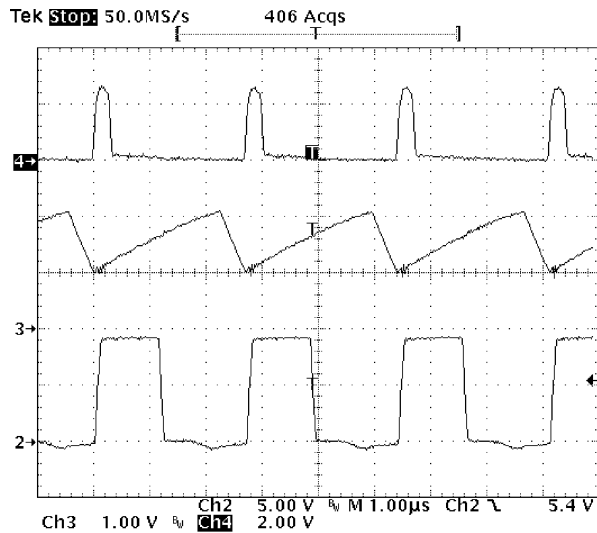

Figure 8. The SYNC Pin Generates a Sync Pulse at the Beginning of Each Switching Cycle. CH2: GATE Pin, CH3: R_TC_T, CH4: SYNC Pin

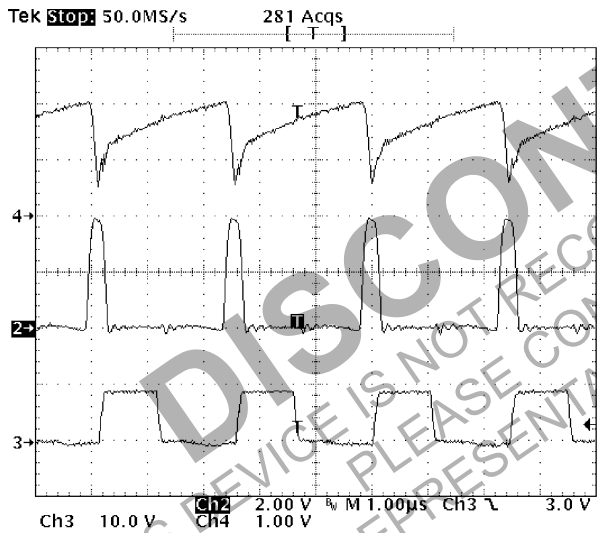

Figure 9. Operation with External Sync. CH2: SYNC Pin, CH3: GATE Pin, CH4: R_TC_T Pin

An external pulse signal can feed to the bidirectional SYNC pin to synchronize the switch frequency. For reliable operation, the sync frequency should be approximately 20% higher than free running IC frequency. As show in Figure 9, when the SYNC pin is triggered by an incoming signal, the IC immediately discharges C_T. The GATE signal is turned on once the R_TC_T pin reaches the valley voltage. Because of the steep falling edge, this valley voltage falls below the regular 1.0 V threshold. However, the R_TC_T pin voltage is then quickly raised by a clamp. When the R_TC_T pin reaches the 0.95 V (typ) Valley Clamp Voltage, the clamp is disconnected after a brief delay and C_T is charged through R_T.

Switch Frequency and Maximum Duty Cycle Calculations

Oscillator timing capacitor, C_T, is charged by V_{REF} through R_T and discharged by an internal current source. During the discharge time, the internal clock signal sets the Gate output to the low state, thus providing a user selectable maximum duty cycle clamp. Charge and discharge times are determined by following general formulas;

$$t_C = R_T C_T \ln \left(\frac{V_{REF} - V_{VALLEY}}{V_{REF} - V_{PEAK}} \right)$$

$$t_d = R_T C_T \ln \left(\frac{V_{REF} - V_{PEAK} - I_d R_T}{V_{REF} - V_{VALLEY} - I_d R_T} \right)$$

where:

- t_C = charging time;
- t_d = discharging time;
- V_{VALLEY} = valley voltage of the oscillator;
- V_{PEAK} = peak voltage of the oscillator.

Substituting in typical values for the parameters in the above formulas, V_{REF} = 3.3 V, V_{VALLEY} = 1.0 V, V_{PEAK} = 2.0 V, I_d = 1.0 mA:

$$t_C = 0.57 R_T C_T$$

$$t_d = R_T C_T \ln \left(\frac{1.3 - 0.001 R_T}{2.3 - 0.001 R_T} \right)$$

$$D_{max} = \frac{0.57}{0.57 + \ln \left(\frac{1.3 - 0.001 R_T}{2.3 - 0.001 R_T} \right)}$$

It is noticed from the equation that for the oscillator to function properly, R_T has to be greater than 2.3 k.

Select RC for Feed Forward Ramp

If the line voltage is much greater than the FF pin Peak Voltage, the charge current can be treated as a constant and is equal to V_{IN}/R. Therefore, the volt-second value is determined by:

$$V_{IN} \times T_{ON} = (V_{COMP} - V_{FF(d)}) \times R \times C$$

where:

- V_{COMP} = COMP pin voltage;
- V_{FF(d)} = FF pin discharge voltage.

As shown in the equation, the volt-second clamp is set by the V_{COMP} clamp voltage which is equal to 1.8 V. In Forward or Flyback circuits, the volt-second clamp value is designed to prevent transformers from saturation.

In a buck or forward converter, volt-second is equal to

$$V_{IN} \times T_{ON} = \left(\frac{V_{OUT} \times T_S}{n} \right)$$

n = transformer turns ratio, which is a constant determined by the regulated output voltage, switching period and transformer turns ration (use 1.0 for buck converter). It is interesting to notice from the aforementioned two equations

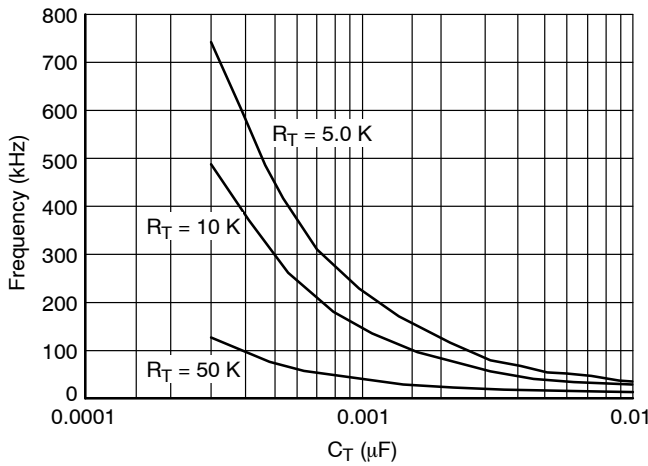

Figure 10. Typical Performance Characteristics, Oscillator Frequency vs. C_T

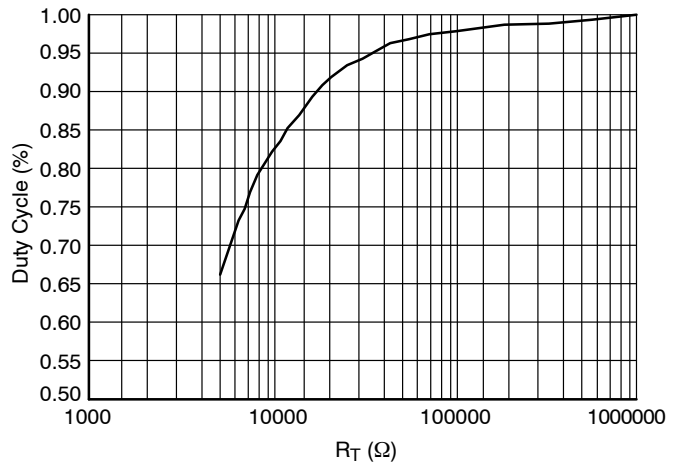

Figure 11. Typical Performance Characteristics, Oscillator Duty Cycle vs. R_T

that during steady state, V_{COMP} doesn't change for input voltage variations. This intuitively explains why FF voltage mode control has superior line regulation and line transient response. Knowing the nominal value of V_{IN} and T_{ON} , one can also select the value of RC to place V_{COMP} at the center of its dynamic range.

Select Feedback Voltage Divider

As shown in Figure 12, the voltage divider output feeds to the FB pin, which connects to the inverting input of the error amplifier. The non-inverting input of the error amplifier is connected to a 1.27 V (typ) reference voltage. The FB pin has an input current which has to be considered for accurate DC outputs. The following equation can be used to calculate the $R1$ and $R2$ value

$$\left(\frac{R2}{R1 + R2}\right)V_{OUT} = 1.27 - \nabla$$

where ∇ is the correction factor due to the existence of the FB pin input current I_{er} .

$$\nabla = (R_i + R1//R2)I_{er}$$

R_i = DC resistance between the FB pin and the voltage divider output.

I_{er} = V_{FB} input current, 1.3 μA typical.

Design Voltage Dividers for OV and UV Detection

In Figure 13, the voltage divider uses three resistors in series to set OV and UV threshold seen from the input voltage. The values of the resistors can be calculated from the following three equations, where the third equation is derived from OV hysteresis requirement.

$$V_{IN(LOW)} \times \left(\frac{R2 + R3}{R2 + R3 + R1}\right) = 1.0 V \quad (A)$$

$$V_{IN(HIGH)} \times \left(\frac{R3}{R2 + R3 + R1}\right) = 2.0 V \quad (B)$$

$$12.5 \mu A \times (R1 + R2) = V_{HYST} \quad (C)$$

where:

$V_{IN(LOW)}$, $V_{IN(HIGH)}$ = input voltage OV and UV threshold;

V_{HYST} = OV hysteresis seen at V_{IN}

It is self-evident from equation A and B that to use this design, $V_{IN(HIGH)}$ has to be two times greater than $V_{IN(LOW)}$. Otherwise, two voltage dividers have to be used to program OV and UV separately.

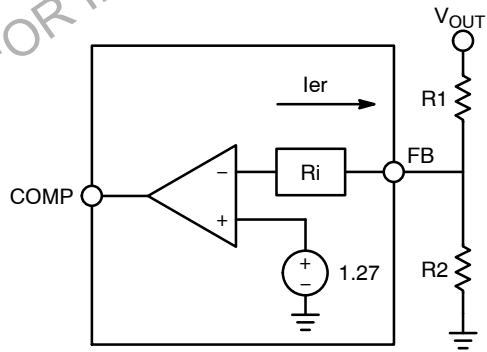

Figure 12. The Design of Feedback Voltage Divider Has to Consider the Error Amplifier Input Current

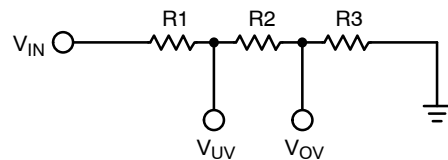

Figure 13. OV/UV Monitor Divider

CS51221

PACKAGE THERMAL DATA

Parameter		SOIC-16	Unit
R _{θJC}	Typical	28	°C/W
R _{θJA}	Typical	115	°C/W

ORDERING INFORMATION

Device	Package	Shipping†
CS51221EDR16G	SOIC-16 (Pb-Free)	2500 Tape & Reel

†For information on tape and reel specifications, including part orientation and tape sizes, please refer to our Tape and Reel Packaging Specifications Brochure, BRD8011/D.

DISCONTINUED
THIS DEVICE IS NOT RECOMMENDED FOR NEW DESIGN
PLEASE CONTACT YOUR onsemi
REPRESENTATIVE FOR INFORMATION

MECHANICAL CASE OUTLINE

PACKAGE DIMENSIONS



SOIC-16 9.90x3.90x1.50 1.27P
CASE 751B
ISSUE L

DATE 29 MAY 2024

NOTES:

1. DIMENSIONING AND TOLERANCING PER ASME Y14.5M, 2018.
2. DIMENSION IN MILLIMETERS. ANGLE IN DEGREES.
3. DIMENSIONS D AND E1 DO NOT INCLUDE MOLD PROTRUSION.
4. MAXIMUM MOLD PROTRUSION 0.15mm PER SIDE.
5. DIMENSION b DOES NOT INCLUDE DAMBAR PROTRUSION. ALLOWABLE DAMBAR PROTRUSION SHALL BE 0.127mm TOTAL IN EXCESS OF THE b DIMENSION AT MAXIMUM MATERIAL CONDITION.

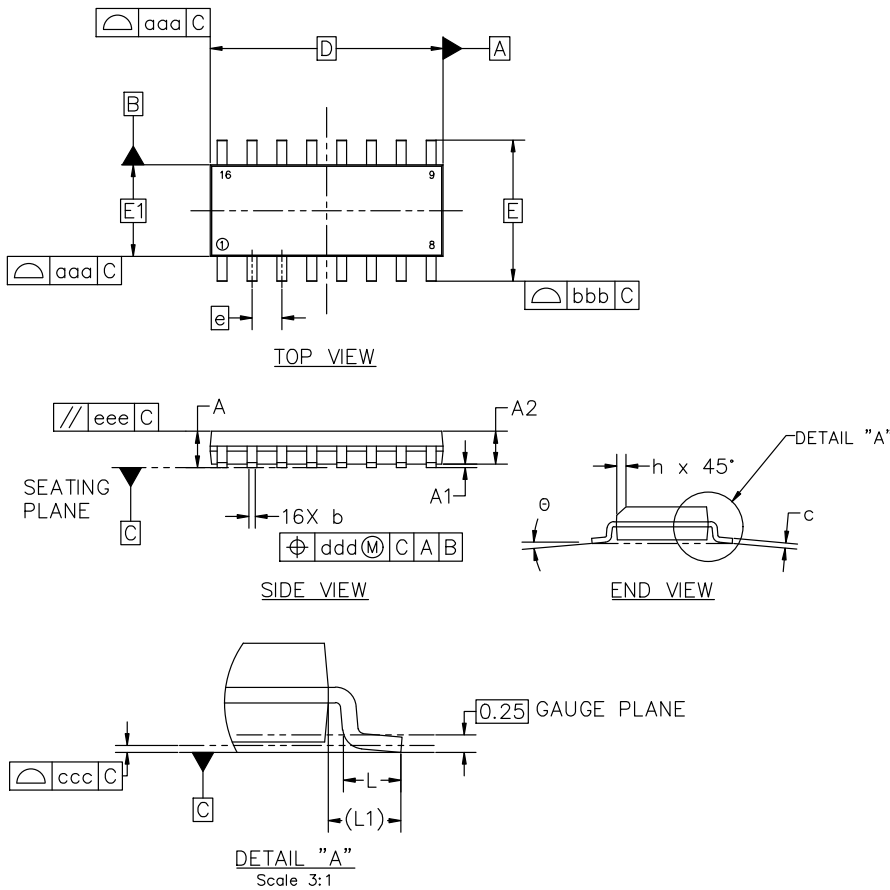

MILLIMETERS			
DIM	MIN	NOM	MAX
A	1.35	1.55	1.75
A1	0.00	0.05	0.10
A2	1.35	1.50	1.65
b	0.35	0.42	0.49
c	0.19	0.22	0.25
D	9.90 BSC		
E	6.00 BSC		
E1	3.90 BSC		
e	1.27 BSC		
h	0.25	---	0.50
L	0.40	0.83	1.25
L1	1.05 REF		
θ	0°	---	7°
TOLERANCE OF FORM AND POSITION			
aaa	0.10		
bbb	0.20		
ccc	0.10		
ddd	0.25		
eee	0.10		



RECOMMENDED MOUNTING FOOTPRINT

*FOR ADDITIONAL INFORMATION ON OUR PB-FREE STRATEGY AND SOLDERING DETAILS, PLEASE DOWNLOAD THE onsemi SOLDERING AND MOUNTING TECHNIQUES REFERENCE MANUAL, SOLDERRM/D

DOCUMENT NUMBER:	98ASB42566B	Electronic versions are uncontrolled except when accessed directly from the Document Repository. Printed versions are uncontrolled except when stamped "CONTROLLED COPY" in red.
DESCRIPTION:	SOIC-16 9.90X3.90X1.50 1.27P	PAGE 1 OF 2

onsemi and onsemi are trademarks of Semiconductor Components Industries, LLC dba onsemi or its subsidiaries in the United States and/or other countries. onsemi reserves the right to make changes without further notice to any products herein. onsemi makes no warranty, representation or guarantee regarding the suitability of its products for any particular purpose, nor does onsemi assume any liability arising out of the application or use of any product or circuit, and specifically disclaims any and all liability, including without limitation special, consequential or incidental damages. onsemi does not convey any license under its patent rights nor the rights of others.

SOIC-16 9.90x3.90x1.50 1.27P
CASE 751B
ISSUE L

DATE 29 MAY 2024

GENERIC MARKING DIAGRAM*

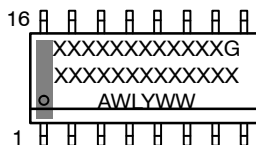

XXXXX = Specific Device Code
A = Assembly Location
WL = Wafer Lot
Y = Year
WW = Work Week
G = Pb-Free Package

*This information is generic. Please refer to device data sheet for actual part marking. Pb-Free indicator, "G" or microdot "•", may or may not be present. Some products may not follow the Generic Marking.

<p>STYLE 1:</p> <p>PIN 1. COLLECTOR 2. BASE 3. EMITTER 4. NO CONNECTION 5. EMITTER 6. BASE 7. COLLECTOR 8. COLLECTOR 9. BASE 10. EMITTER 11. NO CONNECTION 12. EMITTER 13. BASE 14. COLLECTOR 15. EMITTER 16. COLLECTOR</p>	<p>STYLE 2:</p> <p>PIN 1. CATHODE 2. ANODE 3. NO CONNECTION 4. CATHODE 5. CATHODE 6. NO CONNECTION 7. ANODE 8. CATHODE 9. CATHODE 10. ANODE 11. NO CONNECTION 12. CATHODE 13. CATHODE 14. NO CONNECTION 15. ANODE 16. CATHODE</p>	<p>STYLE 3:</p> <p>PIN 1. COLLECTOR, DYE #1 2. BASE, #1 3. EMITTER, #1 4. COLLECTOR, #1 5. COLLECTOR, #2 6. BASE, #2 7. EMITTER, #2 8. COLLECTOR, #2 9. COLLECTOR, #3 10. BASE, #3 11. EMITTER, #3 12. COLLECTOR, #3 13. COLLECTOR, #4 14. BASE, #4 15. EMITTER, #4 16. COLLECTOR, #4</p>	<p>STYLE 4:</p> <p>PIN 1. COLLECTOR, DYE #1 2. COLLECTOR, #1 3. COLLECTOR, #2 4. COLLECTOR, #2 5. COLLECTOR, #3 6. COLLECTOR, #3 7. COLLECTOR, #4 8. COLLECTOR, #4 9. BASE, #4 10. EMITTER, #4 11. BASE, #3 12. EMITTER, #3 13. BASE, #2 14. EMITTER, #2 15. BASE, #1 16. EMITTER, #1</p>
<p>STYLE 5:</p> <p>PIN 1. DRAIN, DYE #1 2. DRAIN, #1 3. DRAIN, #2 4. DRAIN, #2 5. DRAIN, #3 6. DRAIN, #3 7. DRAIN, #4 8. DRAIN, #4 9. GATE, #4 10. SOURCE, #4 11. GATE, #3 12. SOURCE, #3 13. GATE, #2 14. SOURCE, #2 15. GATE, #1 16. SOURCE, #1</p>	<p>STYLE 6:</p> <p>PIN 1. CATHODE 2. CATHODE 3. CATHODE 4. CATHODE 5. CATHODE 6. CATHODE 7. CATHODE 8. CATHODE 9. ANODE 10. ANODE 11. ANODE 12. ANODE 13. ANODE 14. ANODE 15. ANODE 16. ANODE</p>	<p>STYLE 7:</p> <p>PIN 1. SOURCE N-CH 2. COMMON DRAIN (OUTPUT) 3. COMMON DRAIN (OUTPUT) 4. GATE P-CH 5. COMMON DRAIN (OUTPUT) 6. COMMON DRAIN (OUTPUT) 7. COMMON DRAIN (OUTPUT) 8. SOURCE P-CH 9. SOURCE P-CH 10. COMMON DRAIN (OUTPUT) 11. COMMON DRAIN (OUTPUT) 12. COMMON DRAIN (OUTPUT) 13. GATE N-CH 14. COMMON DRAIN (OUTPUT) 15. COMMON DRAIN (OUTPUT) 16. SOURCE N-CH</p>	

DOCUMENT NUMBER:	98ASB42566B	Electronic versions are uncontrolled except when accessed directly from the Document Repository. Printed versions are uncontrolled except when stamped "CONTROLLED COPY" in red.
DESCRIPTION:	SOIC-16 9.90X3.90X1.50 1.27P	PAGE 2 OF 2

onsemi and onsemi are trademarks of Semiconductor Components Industries, LLC dba onsemi or its subsidiaries in the United States and/or other countries. onsemi reserves the right to make changes without further notice to any products herein. onsemi makes no warranty, representation or guarantee regarding the suitability of its products for any particular purpose, nor does onsemi assume any liability arising out of the application or use of any product or circuit, and specifically disclaims any and all liability, including without limitation special, consequential or incidental damages. onsemi does not convey any license under its patent rights nor the rights of others.

onsemi, **Onsemi**, and other names, marks, and brands are registered and/or common law trademarks of Semiconductor Components Industries, LLC dba "**onsemi**" or its affiliates and/or subsidiaries in the United States and/or other countries. **onsemi** owns the rights to a number of patents, trademarks, copyrights, trade secrets, and other intellectual property. A listing of **onsemi**'s product/patent coverage may be accessed at www.onsemi.com/site/pdf/Patent-Marking.pdf. **onsemi** reserves the right to make changes at any time to any products or information herein, without notice. The information herein is provided "as-is" and **onsemi** makes no warranty, representation or guarantee regarding the accuracy of the information, product features, availability, functionality, or suitability of its products for any particular purpose, nor does **onsemi** assume any liability arising out of the application or use of any product or circuit, and specifically disclaims any and all liability, including without limitation special, consequential or incidental damages. Buyer is responsible for its products and applications using **onsemi** products, including compliance with all laws, regulations and safety requirements or standards, regardless of any support or applications information provided by **onsemi**. "Typical" parameters which may be provided in **onsemi** data sheets and/or specifications can and do vary in different applications and actual performance may vary over time. All operating parameters, including "Typicals" must be validated for each customer application by customer's technical experts. **onsemi** does not convey any license under any of its intellectual property rights nor the rights of others. **onsemi** products are not designed, intended, or authorized for use as a critical component in life support systems or any FDA Class 3 medical devices or medical devices with a same or similar classification in a foreign jurisdiction or any devices intended for implantation in the human body. Should Buyer purchase or use **onsemi** products for any such unintended or unauthorized application, Buyer shall indemnify and hold **onsemi** and its officers, employees, subsidiaries, affiliates, and distributors harmless against all claims, costs, damages, and expenses, and reasonable attorney fees arising out of, directly or indirectly, any claim of personal injury or death associated with such unintended or unauthorized use, even if such claim alleges that **onsemi** was negligent regarding the design or manufacture of the part. **onsemi** is an Equal Opportunity/Affirmative Action Employer. This literature is subject to all applicable copyright laws and is not for resale in any manner.

ADDITIONAL INFORMATION

TECHNICAL PUBLICATIONS:

Technical Library: www.onsemi.com/design/resources/technical-documentation
onsemi Website: www.onsemi.com

ONLINE SUPPORT: www.onsemi.com/support

For additional information, please contact your local Sales Representative at www.onsemi.com/support/sales