

MOSFET - Power, Single N-Channel

35 V, 104 mΩ, 3 A

CPH3455

Description

This Power MOSFET is produced using onsemi's trench technology, which is specifically designed to minimize gate charge and low on resistance. This device is suitable for applications with low gate charge driving or low on resistance requirements.

Features

- Low On-Resistance
- 4V Drive
- Pb-Free, Halogen Free and RoHS Compliance

Typical Applications

- Load Switch
- Motor Drive

MAXIMUM RATINGS (T_J = 25°C unless otherwise noted) (Note 1)

| Parameter | Symbol | Value | Unit |
|--|------------------|-------------|------|
| Drain-to-Source Voltage | V _{DSS} | 35 | V |
| Gate-to-Source Voltage | V _{GSS} | ±20 | V |
| Drain Current (DC) | I _D | 3 | A |
| Drain Current (Pulse) PW ≤ 10 μs, duty cycle ≤ 1% | I _{DP} | 12 | A |
| Power Dissipation When mounted on ceramic substrate (900 mm ² × 0.8 mm) | P _D | 1 | W |
| Junction Temperature | T _J | 150 | °C |
| Storage Temperature | T _{stg} | -55 to +150 | °C |

Stresses exceeding those listed in the Maximum Ratings table may damage the device. If any of these limits are exceeded, device functionality should not be assumed, damage may occur and reliability may be affected.

1. This product is designed to "ESD immunity <200 V*", so please take care when handling.

*Machine Model

THERMAL RESISTANCE MAXIMUM RATINGS

| Parameter | Symbol | Value | Unit |
|--|------------------|-------|------|
| Junction-to-Ambient When mounted on ceramic substrate (900 mm ² × 0.8 mm) | R _{θJA} | 125 | °C/W |

| V _{(BR)DSS} | R _{DS(ON) MAX} | I _{D MAX} |
|----------------------|-------------------------|--------------------|
| 35 V | 104 mΩ @ 10 V | 3 A |
| | 173 mΩ @ 4.5 V | |
| | 208 mΩ @ 4 V | |

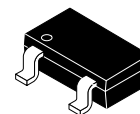

CPH3
CASE 318BA

ELECTRICAL CONNECTION N-Channel

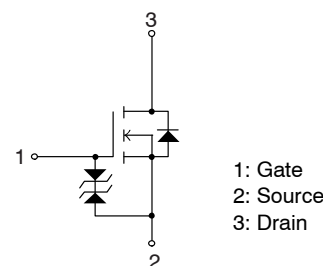

MARKING DIAGRAM

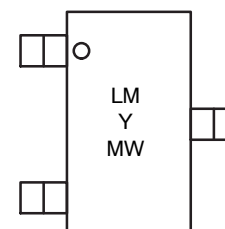

LM = Specific Device Code
Y = Year
M = Month
W = Week

ORDERING INFORMATION

See detailed ordering, marking and shipping information in the package dimensions section on page 5 of this data sheet.

CPH3455

ELECTRICAL CHARACTERISTICS (T_J = 25°C unless otherwise specified)

| Parameter | Symbol | Test Condition | Min | Typ | Max | Unit |
|--|----------------------|--|-----|------|-----|------|
| Drain to Source Breakdown Voltage | V _{(BR)DSS} | I _D = 1 mA, V _{GS} = 0 V | 35 | - | - | V |
| Zero-Gate Voltage Drain Current | I _{DSS} | V _{DS} = 35 V, V _{GS} = 0 V | - | - | 1 | μA |
| Gate to Source Leakage Current | I _{GSS} | V _{GS} = ±16 V, V _{DS} = 0 V | - | - | ±10 | μA |
| Gate Threshold Voltage | V _{GS(th)} | V _{DS} = 10 V, I _D = 1 mA | 1.2 | - | 2.6 | V |
| Forward Transconductance | g _{FS} | V _{DS} = 10 V, I _D = 1.5 A | - | 1.7 | - | S |
| Static Drain to Source On-State Resistance | R _{DS(on)1} | I _D = 1.5 A, V _{GS} = 10 V | - | 80 | 104 | mΩ |
| | R _{DS(on)2} | I _D = 0.75 A, V _{GS} = 4.5 V | - | 123 | 173 | mΩ |
| | R _{DS(on)3} | I _D = 0.75 A, V _{GS} = 4 V | - | 148 | 208 | mΩ |
| Input Capacitance | C _{iSS} | V _{DS} = 20 V, f = 1 MHz | - | 186 | - | pF |
| Output Capacitance | C _{oSS} | | - | 36 | - | |
| Reverse Transfer Capacitance | C _{rSS} | | - | 22 | - | |
| Turn-On Delay Time | t _{d(on)} | See specified Test Circuit | - | 4.2 | - | ns |
| Rise Time | t _r | | - | 4.7 | - | |
| Turn-Off Delay Time | t _{d(off)} | | - | 15 | - | |
| Fall Time | t _f | | - | 5.7 | - | |
| Total Gate Charge | Q _g | V _{DS} = 20 V, V _{GS} = 10 V, I _D = 3 A | - | 4 | - | nC |
| Gate-to-Source Charge | Q _{gs} | | - | 0.9 | - | |
| Gate to Drain "Miller" Charge | Q _{gd} | | - | 0.7 | - | |
| Forward Diode Voltage | V _{SD} | I _S = 3 A, V _{GS} = 0 V | - | 0.86 | 1.2 | V |

Product parametric performance is indicated in the Electrical Characteristics for the listed test conditions, unless otherwise noted. Product performance may not be indicated by the Electrical Characteristics if operated under different conditions.

SWITCHING TIME TEST CIRCUIT

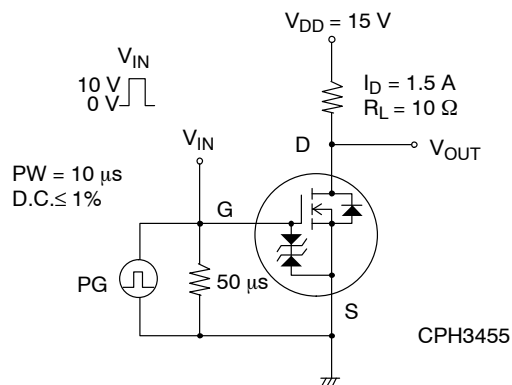

Figure 1. Switching Time Test Circuit

TYPICAL CHARACTERISTICS

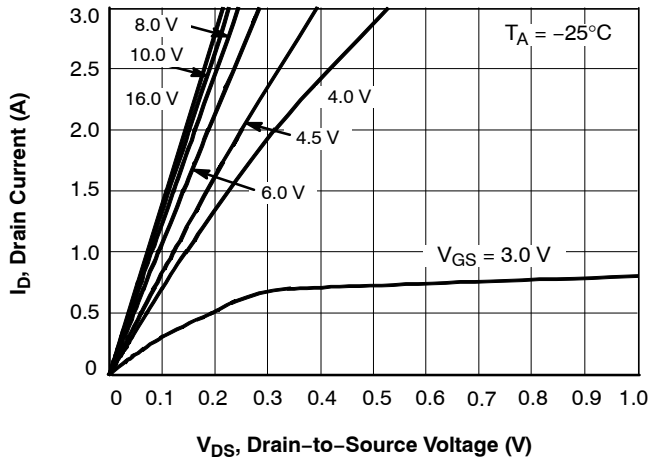

Figure 2. $I_D - V_{DS}$

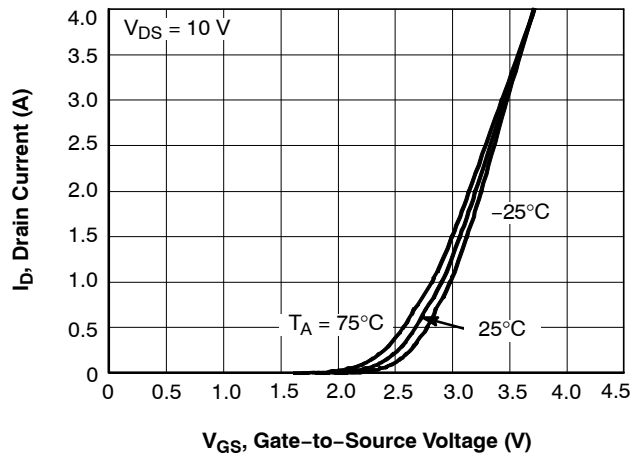

Figure 3. $I_D - V_{GS}$

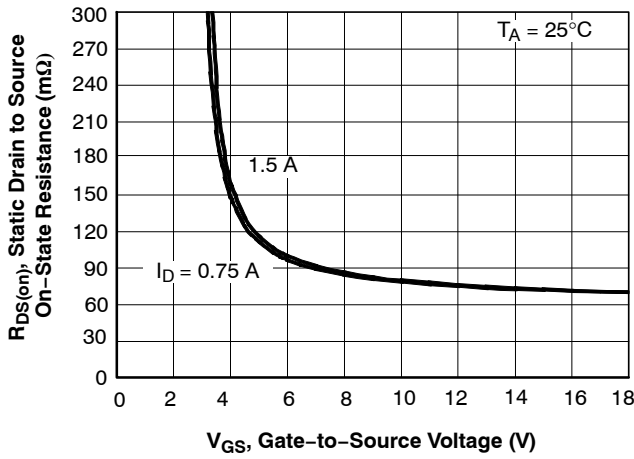

Figure 4. $R_{DS(on)} - V_{GS}$

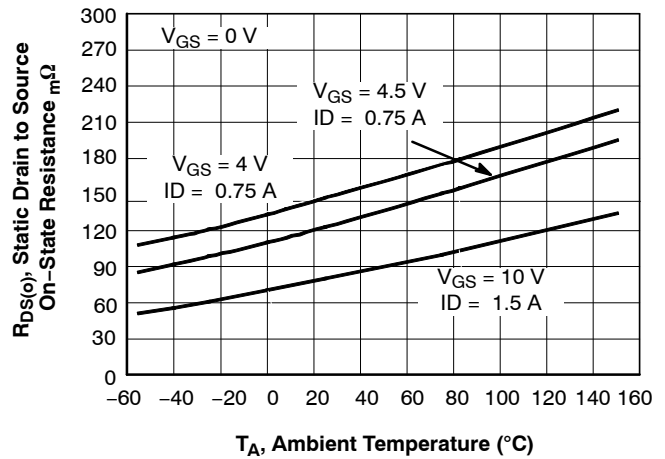

Figure 5. $R_{DS(on)} - T_A$

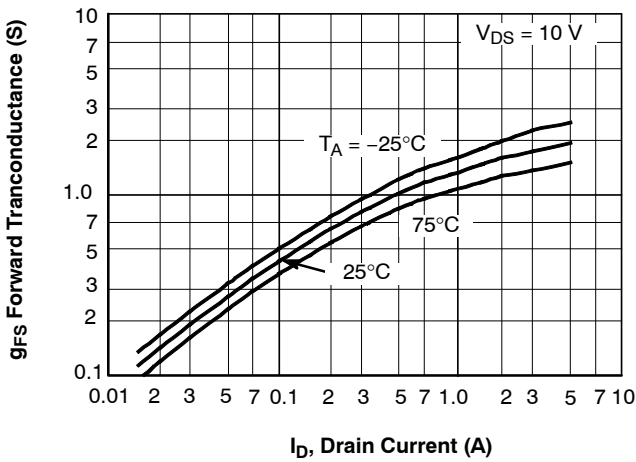

Figure 6. $g_{FS} - I_D$

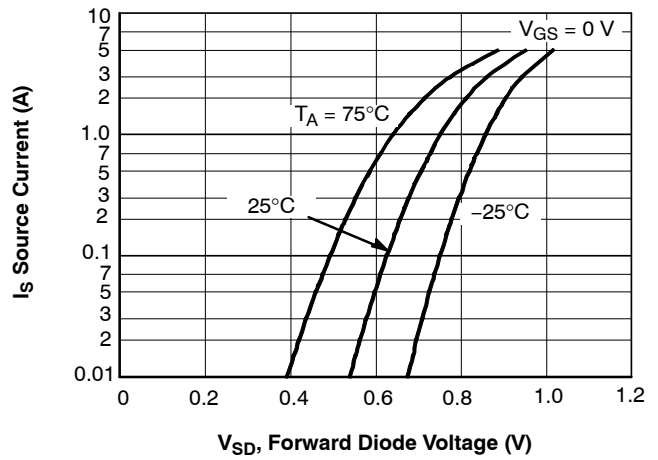

Figure 7. $I_S - V_{SD}$

TYPICAL CHARACTERISTICS (continued)

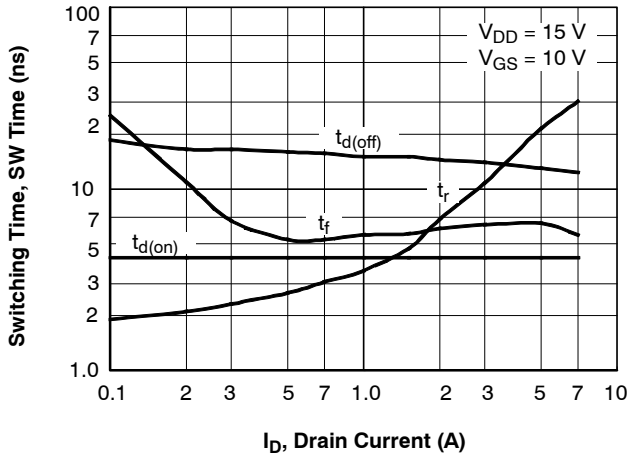

Figure 8. Time (SW) – I_D

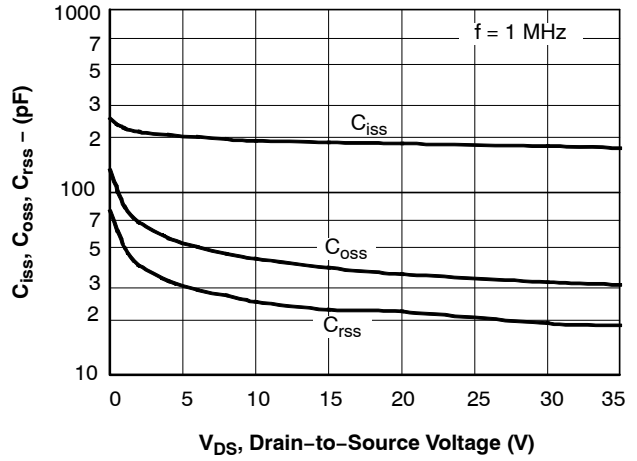

Figure 9. V_{DS} – $C_{iss}, C_{oss}, C_{rss}$

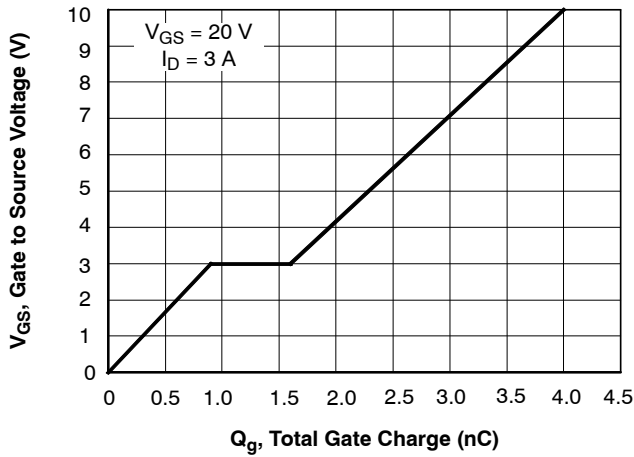

Figure 10. V_{GS} – Q_g

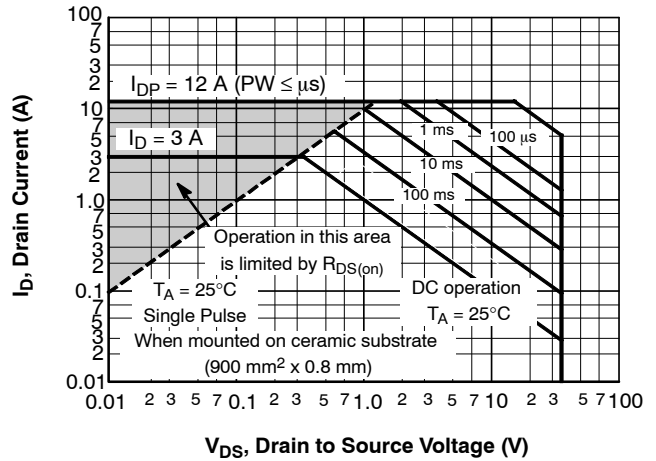

Figure 11. S O A

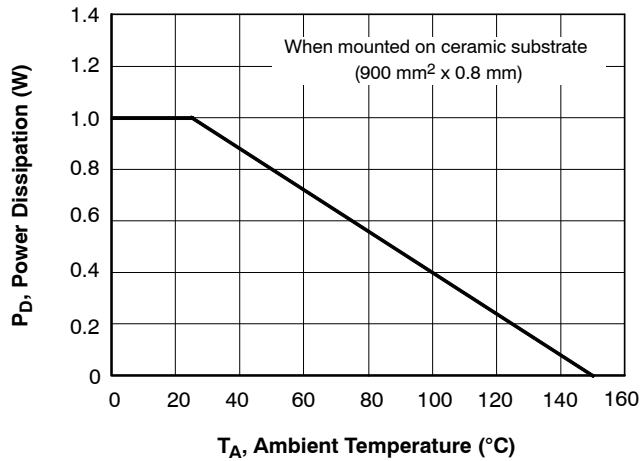

Figure 12. P_D – T_A

CPH3455

TYPICAL CHARACTERISTICS (continued)

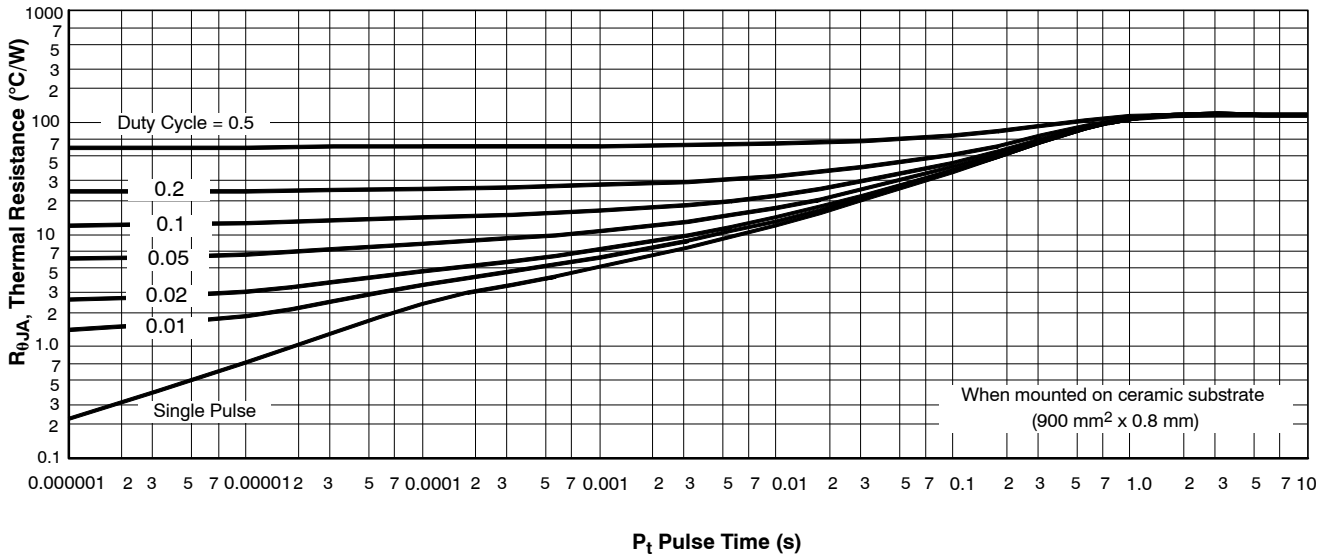

Figure 13. $R_{\theta JA}$ – Pulse Time

DEVICE ORDERING INFORMATION

| Device | Marking | Package | Shipping [†] |
|--------------|---------|---|-----------------------|
| CPH3455-TL-H | LM | CPH3 SC-59, SOT-23, TO-236 (Pb-Free / Halogen Free) | 3000 / Tape & Reel |

[†]For information on tape and reel specifications, including part orientation and tape sizes, please refer to our Tape and Reel Packaging Specifications Brochure, [BRD8011/D](#).

*Note on usage : Since the CPH3455 is a MOSFET product, please avoid using this device in the vicinity of highly charged objects.

MECHANICAL CASE OUTLINE
PACKAGE DIMENSIONS

CPH3
CASE 318BA
ISSUE O

DATE 30 NOV 2011

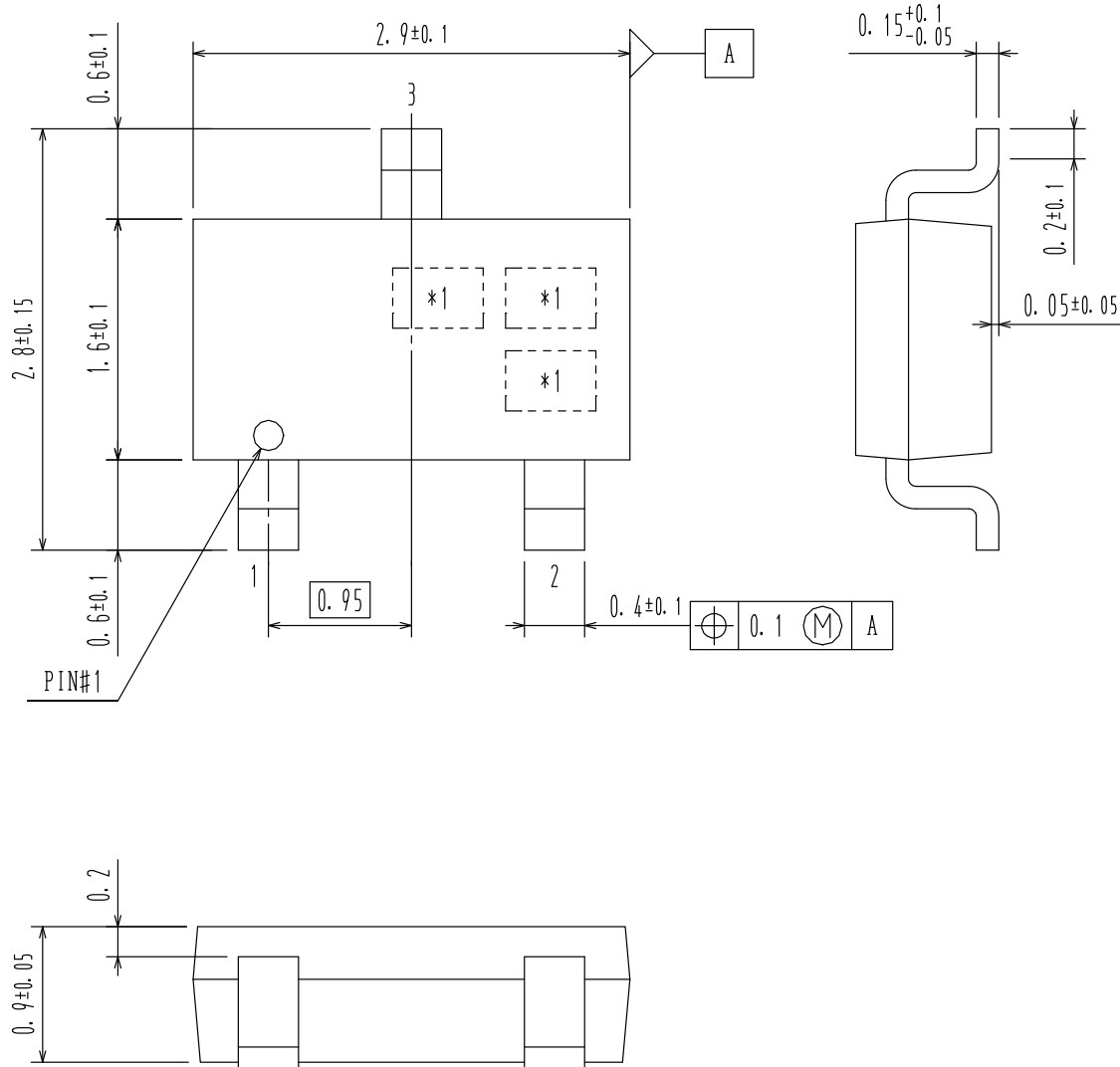

| | | |
|-------------------------|--------------------|---|
| DOCUMENT NUMBER: | 98AON65437E | Electronic versions are uncontrolled except when accessed directly from the Document Repository. Printed versions are uncontrolled except when stamped "CONTROLLED COPY" in red. |
| DESCRIPTION: | CPH3 | PAGE 1 OF 1 |

ON Semiconductor and are trademarks of Semiconductor Components Industries, LLC dba ON Semiconductor or its subsidiaries in the United States and/or other countries. ON Semiconductor reserves the right to make changes without further notice to any products herein. ON Semiconductor makes no warranty, representation or guarantee regarding the suitability of its products for any particular purpose, nor does ON Semiconductor assume any liability arising out of the application or use of any product or circuit, and specifically disclaims any and all liability, including without limitation special, consequential or incidental damages. ON Semiconductor does not convey any license under its patent rights nor the rights of others.

onsemi, **Onsemi**, and other names, marks, and brands are registered and/or common law trademarks of Semiconductor Components Industries, LLC dba "**onsemi**" or its affiliates and/or subsidiaries in the United States and/or other countries. **onsemi** owns the rights to a number of patents, trademarks, copyrights, trade secrets, and other intellectual property. A listing of **onsemi**'s product/patent coverage may be accessed at www.onsemi.com/site/pdf/Patent-Marking.pdf. **onsemi** reserves the right to make changes at any time to any products or information herein, without notice. The information herein is provided "as-is" and **onsemi** makes no warranty, representation or guarantee regarding the accuracy of the information, product features, availability, functionality, or suitability of its products for any particular purpose, nor does **onsemi** assume any liability arising out of the application or use of any product or circuit, and specifically disclaims any and all liability, including without limitation special, consequential or incidental damages. Buyer is responsible for its products and applications using **onsemi** products, including compliance with all laws, regulations and safety requirements or standards, regardless of any support or applications information provided by **onsemi**. "Typical" parameters which may be provided in **onsemi** data sheets and/or specifications can and do vary in different applications and actual performance may vary over time. All operating parameters, including "Typicals" must be validated for each customer application by customer's technical experts. **onsemi** does not convey any license under any of its intellectual property rights nor the rights of others. **onsemi** products are not designed, intended, or authorized for use as a critical component in life support systems or any FDA Class 3 medical devices or medical devices with a same or similar classification in a foreign jurisdiction or any devices intended for implantation in the human body. Should Buyer purchase or use **onsemi** products for any such unintended or unauthorized application, Buyer shall indemnify and hold **onsemi** and its officers, employees, subsidiaries, affiliates, and distributors harmless against all claims, costs, damages, and expenses, and reasonable attorney fees arising out of, directly or indirectly, any claim of personal injury or death associated with such unintended or unauthorized use, even if such claim alleges that **onsemi** was negligent regarding the design or manufacture of the part. **onsemi** is an Equal Opportunity/Affirmative Action Employer. This literature is subject to all applicable copyright laws and is not for resale in any manner.

ADDITIONAL INFORMATION

TECHNICAL PUBLICATIONS:

Technical Library: www.onsemi.com/design/resources/technical-documentation
onsemi Website: www.onsemi.com

ONLINE SUPPORT: www.onsemi.com/support

For additional information, please contact your local Sales Representative at www.onsemi.com/support/sales