

BUD42D

High Speed, High Gain Bipolar NPN Transistor with Antisaturation Network and Transient Voltage Suppression Capability

The BUD42D is a state-of-the-art bipolar transistor. Tight dynamic characteristics and lot to lot minimum spread make it ideally suitable for light ballast applications.

Features

- Free-Wheeling Diode Built-In
- Flat DC Current Gain
- Fast Switching Times and Tight Distribution
- “6 Sigma” Process Providing Tight and Reproducible Parameter Spreads
- Epoxy Meets UL 94 V-0 @ 0.125 in
- These Devices are Pb-Free and are RoHS Compliant

Two Versions

- BUD42D-1: Case 369D for Insertion Mode
- BUD42D, BUD42DT4: Case 369C for Surface Mount Mode

MAXIMUM RATINGS

Rating	Symbol	Value	Unit
Collector-Emitter Sustaining Voltage	V_{CEO}	350	Vdc
Collector-Base Breakdown Voltage	V_{CBO}	650	Vdc
Collector-Emitter Breakdown Voltage	V_{CES}	650	Vdc
Emitter-Base Voltage	V_{EBO}	9	Vdc
Collector Current - Continuous	I_C	4.0	Adc
Collector Current - Peak (Note 1)	I_{CM}	8.0	Adc
Base Current - Continuous	I_B	1.0	Adc
Base Current - Peak (Note 1)	I_{BM}	2.0	Adc
Total Device Dissipation @ $T_C = 25^\circ\text{C}$ Derate above 25°C	P_D	25 0.2	W W/ $^\circ\text{C}$
Operating and Storage Temperature	T_J, T_{stg}	-65 to +150	$^\circ\text{C}$
ESD - Human Body Model	HBM	3B	V
ESD - Machine Model	MM	C	V

TYPICAL GAIN

Typical Gain @ $I_C = 1\text{ A}, V_{CE} = 2\text{ V}$	h_{FE}	13	-
Typical Gain @ $I_C = 0.3\text{ A}, V_{CE} = 1\text{ V}$	h_{FE}	16	-

Stresses exceeding Maximum Ratings may damage the device. Maximum Ratings are stress ratings only. Functional operation above the Recommended Operating Conditions is not implied. Extended exposure to stresses above the Recommended Operating Conditions may affect device reliability.

1. Pulse Test: Pulse Width = 5.0 ms, Duty Cycle = 10%10



ON Semiconductor®

<http://onsemi.com>

**4 AMPERES
650 VOLTS, 25 WATTS
POWER TRANSISTOR**

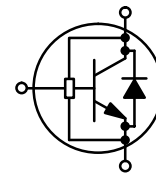

MARKING DIAGRAMS

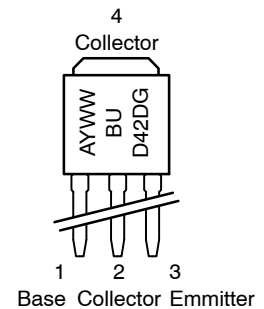
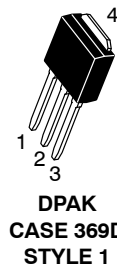
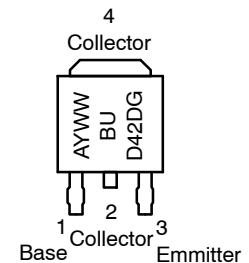

A = Assembly Location
Y = Year
WW = Work Week
BUD43D = Device Code
G = Pb-Free Package

ORDERING INFORMATION

See detailed ordering and shipping information in the package dimensions section on page 10 of this data sheet.

BUD42D

THERMAL CHARACTERISTICS

Characteristic	Symbol	Value	Unit
Thermal Resistance, Junction-to-Case	$R_{\theta JC}$	5.0	$^{\circ}\text{C}/\text{W}$
Thermal Resistance, Junction-to-Ambient	$R_{\theta JA}$	71.4	$^{\circ}\text{C}/\text{W}$
Maximum Lead Temperature for Soldering Purposes: 1/8 in from Case for 5 seconds	T_L	260	$^{\circ}\text{C}$

ELECTRICAL CHARACTERISTICS ($T_C = 25^{\circ}\text{C}$ unless otherwise noted)

Characteristic	Symbol	Min	Typ	Max	Unit
----------------	--------	-----	-----	-----	------

OFF CHARACTERISTICS

Collector-Emitter Sustaining Voltage ($I_C = 100 \text{ mA}$, $L = 25 \text{ mH}$)	$V_{CEO(sus)}$	350	430	-	Vdc	
Collector-Base Breakdown Voltage ($I_{CBO} = 1 \text{ mA}$)	V_{CBO}	650	780	-	Vdc	
Emitter-Base Breakdown Voltage ($I_{EBO} = 1 \text{ mA}$)	V_{EBO}	9.0	12	-	Vdc	
Collector Cutoff Current ($V_{CE} = \text{Rated } V_{CEO}$, $I_B = 0$)	I_{CEO}	@ $T_C = 25^{\circ}\text{C}$	-	-	100	μAdc
		@ $T_C = 125^{\circ}\text{C}$	-	-	200	
Collector Cutoff Current ($V_{CE} = \text{Rated } V_{CES}$, $V_{EB} = 0$)	I_{CES}	@ $T_C = 25^{\circ}\text{C}$	-	-	10	μAdc
		@ $T_C = 125^{\circ}\text{C}$	-	-	200	
Emitter-Cutoff Current ($V_{EB} = 9 \text{ Vdc}$, $I_C = 0$)	I_{EBO}	-	-	100	μAdc	

ON CHARACTERISTICS

Base-Emitter Saturation Voltage ($I_C = 1 \text{ Adc}$, $I_B = 0.2 \text{ Adc}$)	$V_{BE(sat)}$	-	0.85	1.2	Vdc
Collector-Emitter Saturation Voltage ($I_C = 2 \text{ Adc}$, $I_B = 0.5 \text{ Adc}$)	$V_{CE(sat)}$	-	0.2	1.0	Vdc
DC Current Gain ($I_C = 1 \text{ Adc}$, $V_{CE} = 2 \text{ Vdc}$) ($I_C = 2 \text{ Adc}$, $V_{CE} = 5 \text{ Vdc}$)	h_{FE}	8.0 10	13 12	- -	-

DIODE CHARACTERISTICS

Forward Diode Voltage ($I_{EC} = 1.0 \text{ Adc}$)	V_{EC}	-	0.9	1.5	V
---	----------	---	-----	-----	---

SWITCHING CHARACTERISTICS: Resistive Load (D.C. $\leq 10\%$, Pulse Width = 40 μs)

Turn-Off Time ($I_C = 1.2 \text{ Adc}$, $I_{B1} = 0.4 \text{ A}$, $I_{B2} = 0.1 \text{ A}$, $V_{CC} = 300 \text{ V}$)	T_{off}	4.6	-	6.55	μs
Fall Time ($I_C = 2.5 \text{ Adc}$, $I_{B1} = I_{B2} = 0.5 \text{ A}$, $V_{CC} = 150 \text{ V}$, $V_{BE} = -2 \text{ V}$)	T_f	-	-	0.8	μs

DYNAMIC SATURATION VOLTAGE

Dynamic Saturation Voltage: Determined 1 μs and 3 μs respectively after rising I_{B1} reaches 90% of final I_{B1}	$I_C = 400 \text{ mA}$ $I_{B1} = 40 \text{ mA}$ $V_{CC} = 300 \text{ V}$	@ 1 μs	@ $T_C = 25^{\circ}\text{C}$ @ $T_C = 125^{\circ}\text{C}$	$V_{CE(dsat)}$	-	2.8	-	V
		@ 3 μs	@ $T_C = 25^{\circ}\text{C}$ @ $T_C = 125^{\circ}\text{C}$		-	0.75 1.3	-	
	$I_C = 1 \text{ A}$ $I_{B1} = 200 \text{ mA}$ $V_{CC} = 300 \text{ V}$	@ 1 μs	@ $T_C = 25^{\circ}\text{C}$ @ $T_C = 125^{\circ}\text{C}$	-	2.1 4.7	-		
		@ 3 μs	@ $T_C = 25^{\circ}\text{C}$ @ $T_C = 125^{\circ}\text{C}$	-	0.35 0.6	-		

TYPICAL STATIC CHARACTERISTICS

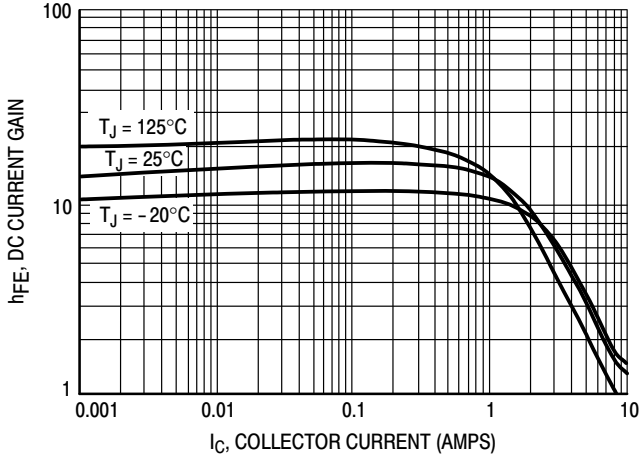

Figure 1. DC Current Gain @ $V_{CE} = 1\text{ V}$

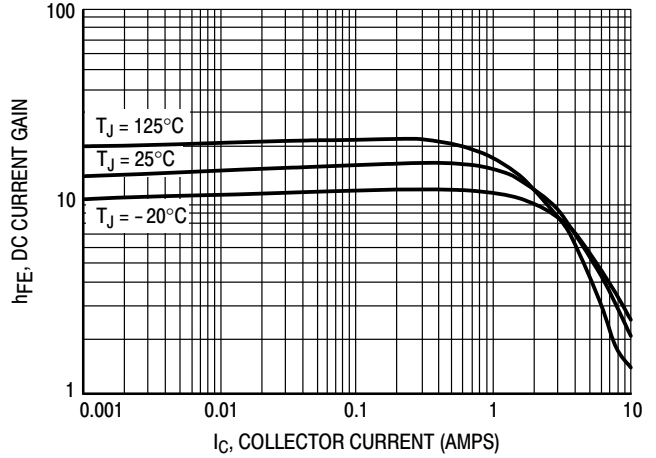

Figure 2. DC Current Gain @ $V_{CE} = 5\text{ V}$

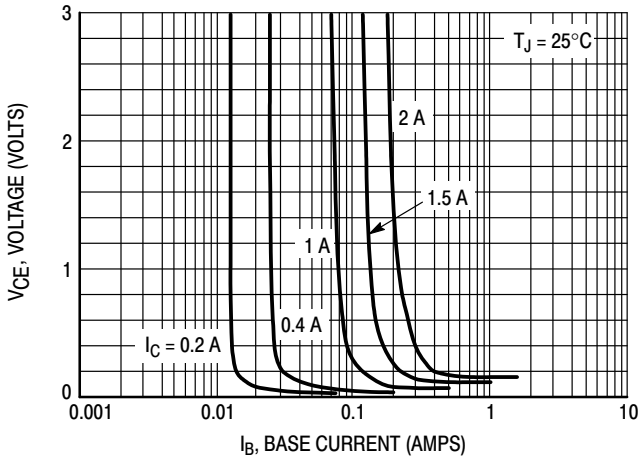

Figure 3. Collector Saturation Region

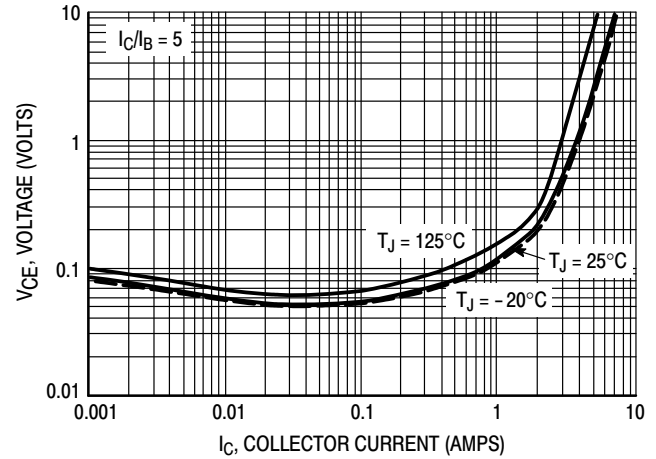

Figure 4. Collector-Emitter Saturation Voltage

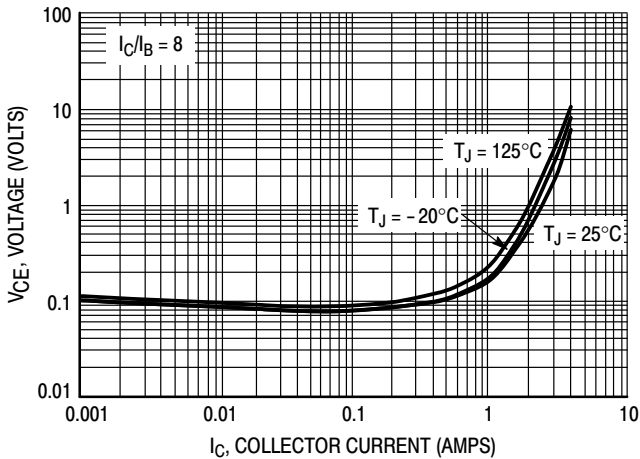

Figure 5. Collector-Emitter Saturation Voltage

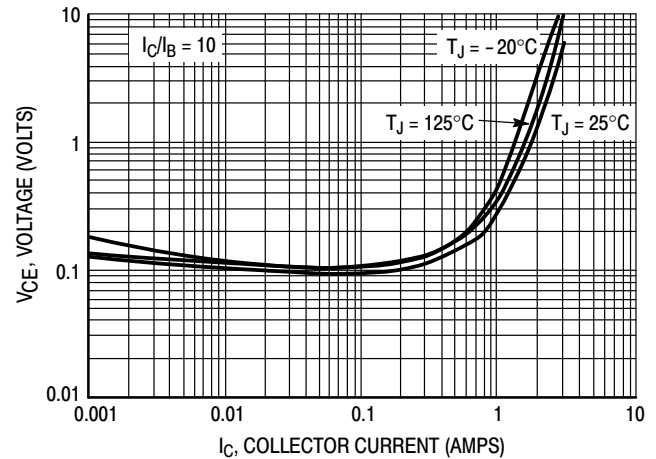

Figure 6. Collector-Emitter Saturation Voltage

BUD42D

TYPICAL STATIC CHARACTERISTICS

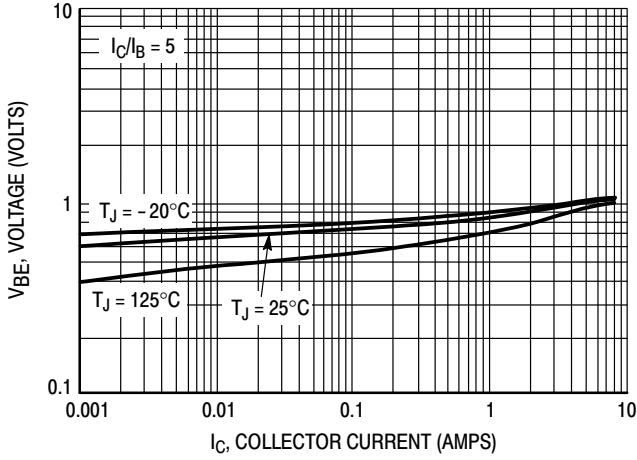

Figure 7. Base-Emitter Saturation Region

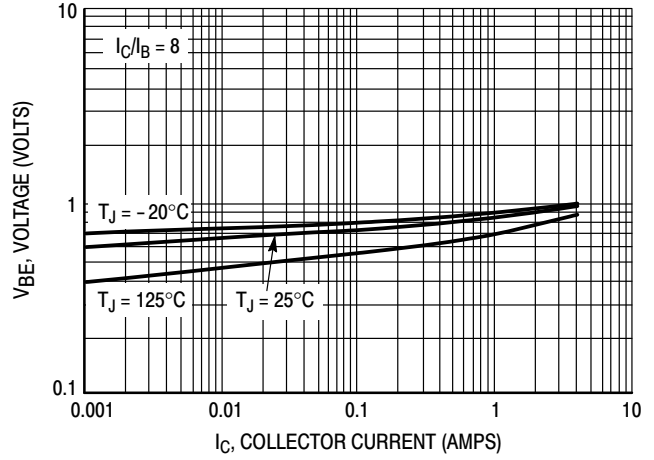

Figure 8. Base-Emitter Saturation Region

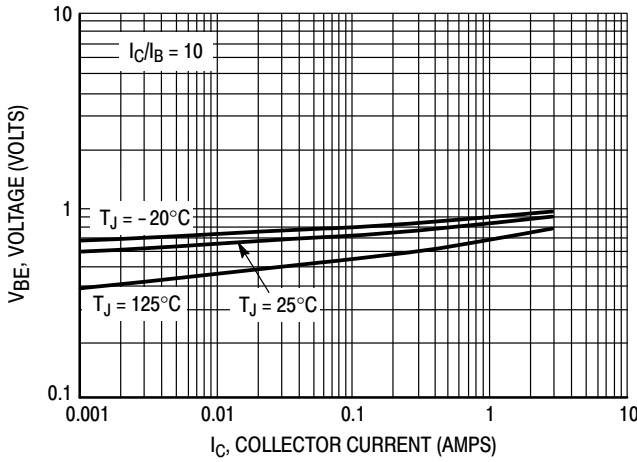

Figure 9. Base-Emitter Saturation Region

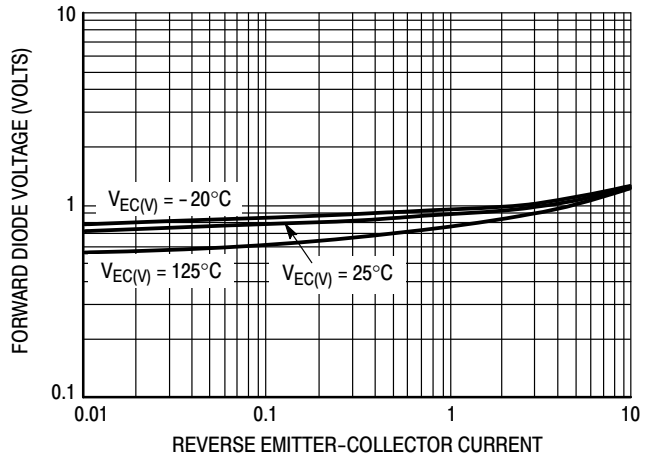

Figure 10. Forward Diode Voltage

TYPICAL SWITCHING CHARACTERISTICS

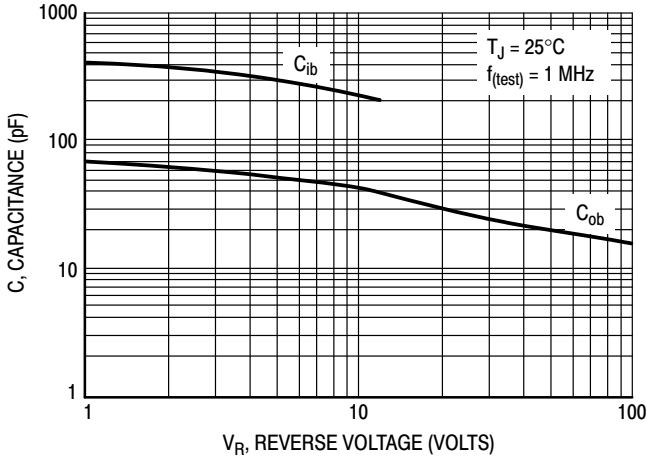

Figure 11. Capacitance

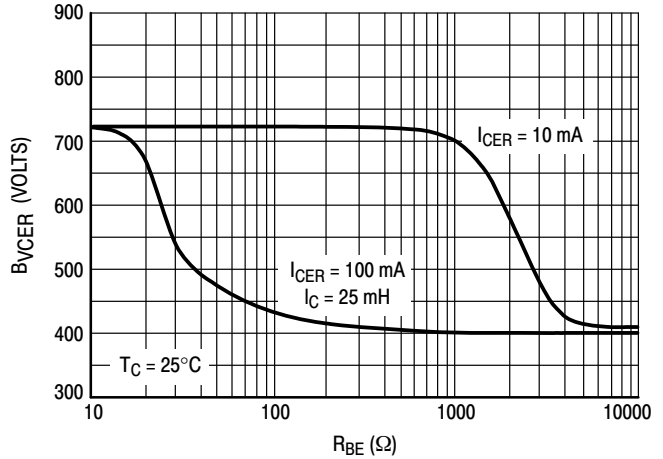

Figure 12. $B_{VCEr} = f(R_{BE})$

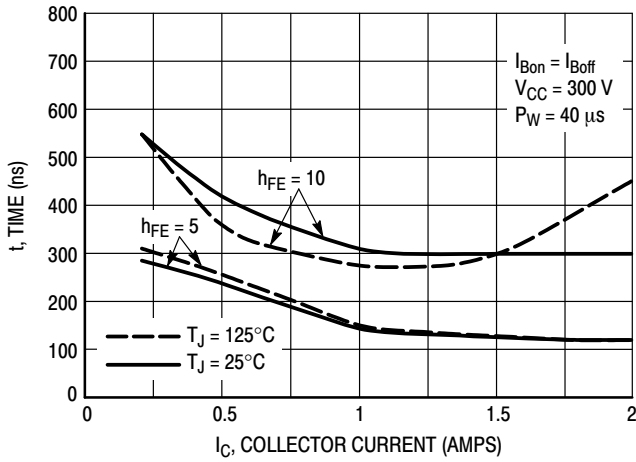

Figure 13. Resistive Switching, t_{on}

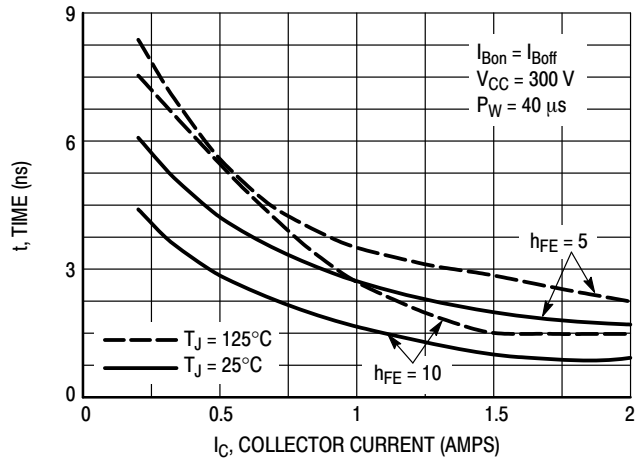

Figure 14. Resistive Switching, t_{off}

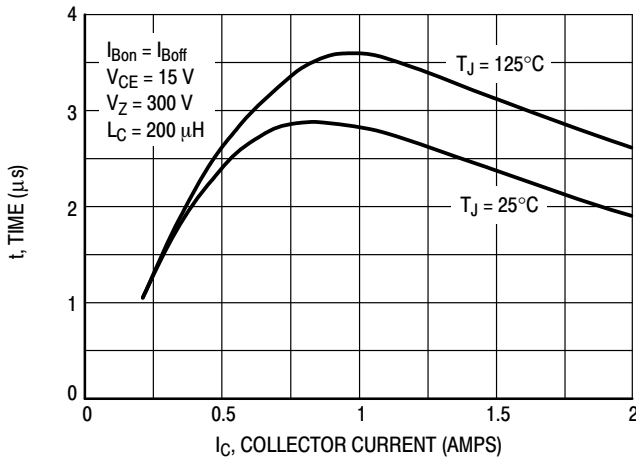

Figure 15. Inductive Storage Time, t_{si} @ $h_{cc} = 5$

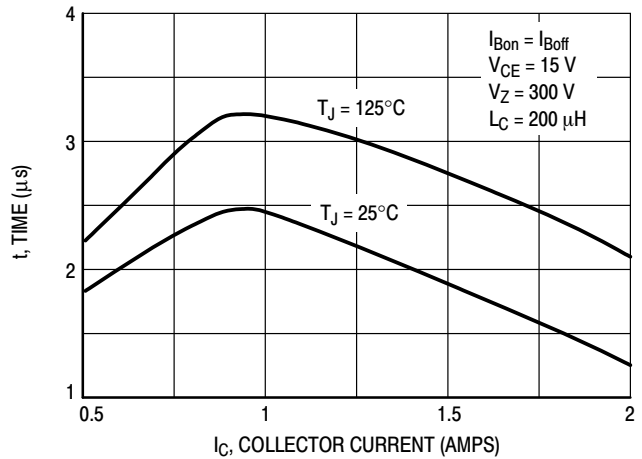

Figure 16. Inductive Storage Time, t_{si} @ $h_{cc} = 10$

TYPICAL SWITCHING CHARACTERISTICS

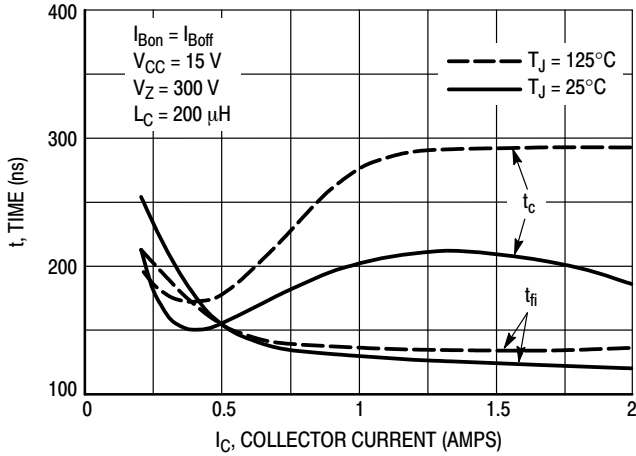

Figure 17. Inductive Fall and Cross Over Time, t_{fi} and t_c @ $h_{FE} = 5$

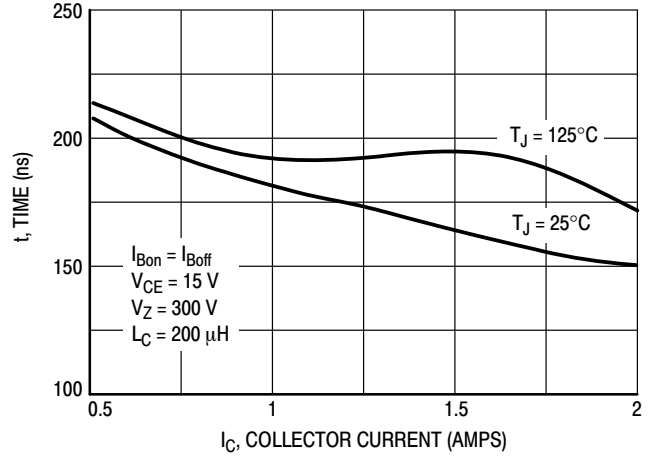

Figure 18. Inductive Fall Time, t_{fi} @ $h_{FE} = 10$

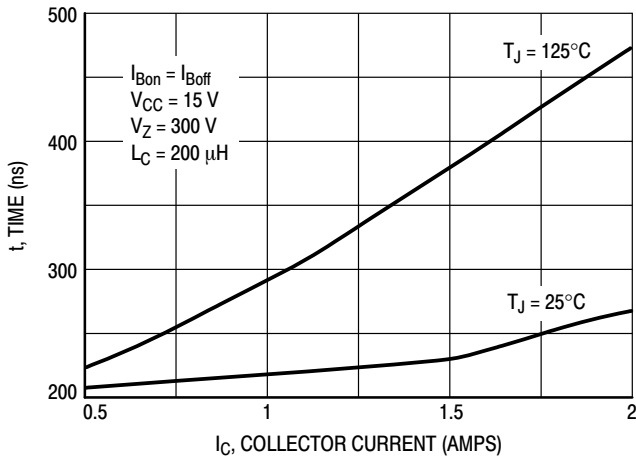

Figure 19. Inductive Cross Over Time, t_c @ $h_{FE} = 10$

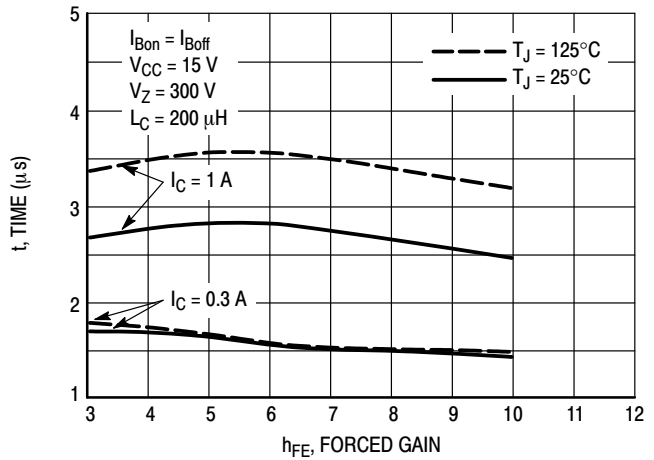

Figure 20. Inductive Storage Time, t_{si}

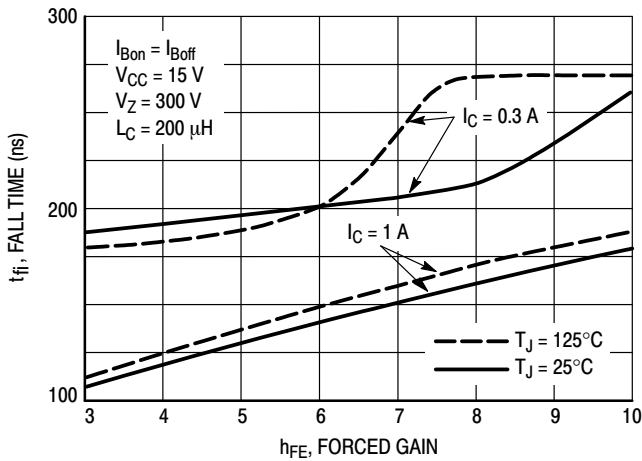

Figure 21. Inductive Fall Time, t_f

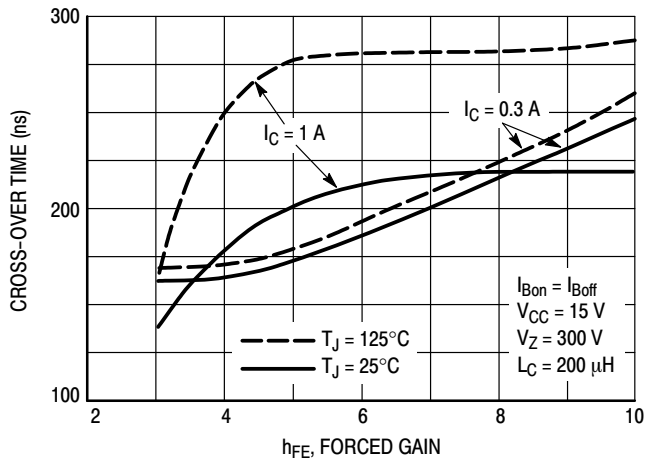

Figure 22. Inductive Cross Over Time, t_c

BUD42D

TYPICAL SWITCHING CHARACTERISTICS

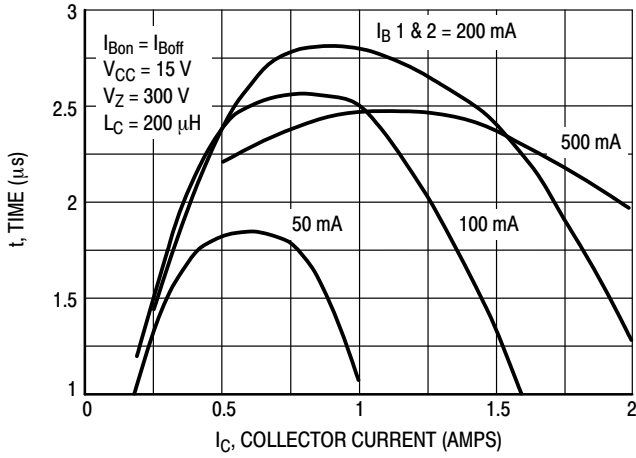

Figure 23. Inductive Storage Time, t_{si}

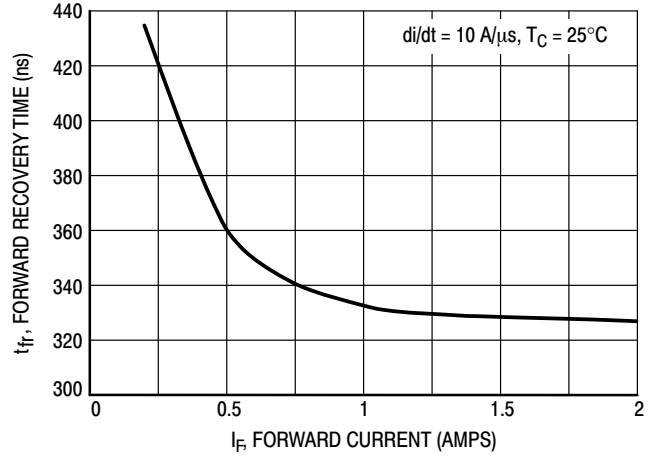

Figure 24. Forward Recovery Time, t_{fr}

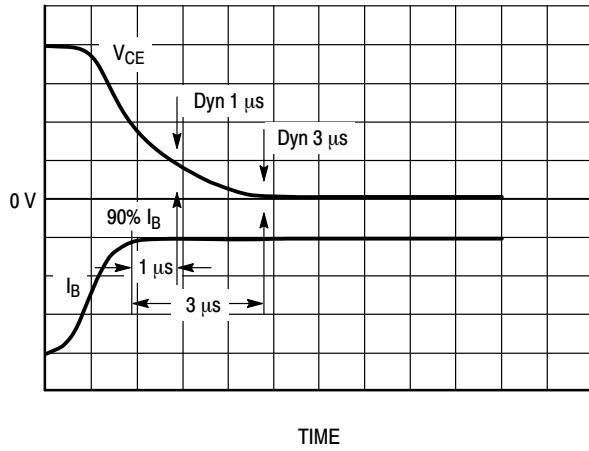

Figure 25. Dynamic Saturation Voltage Measurements

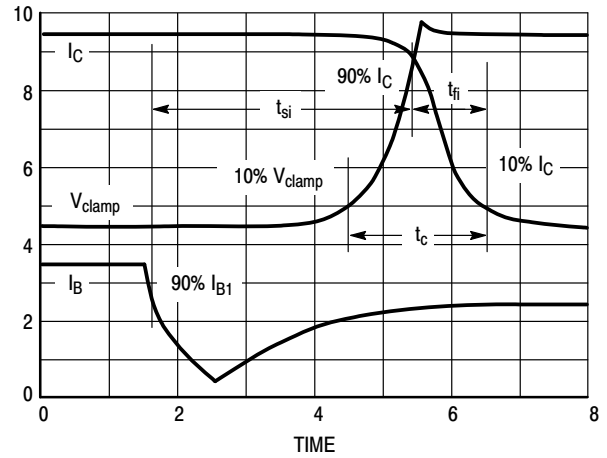
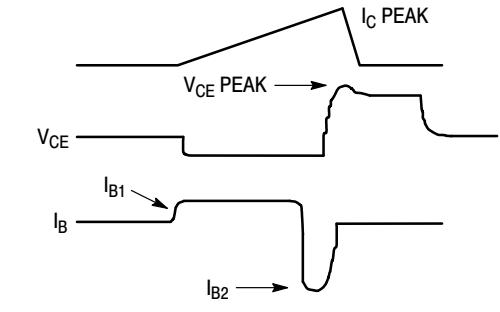
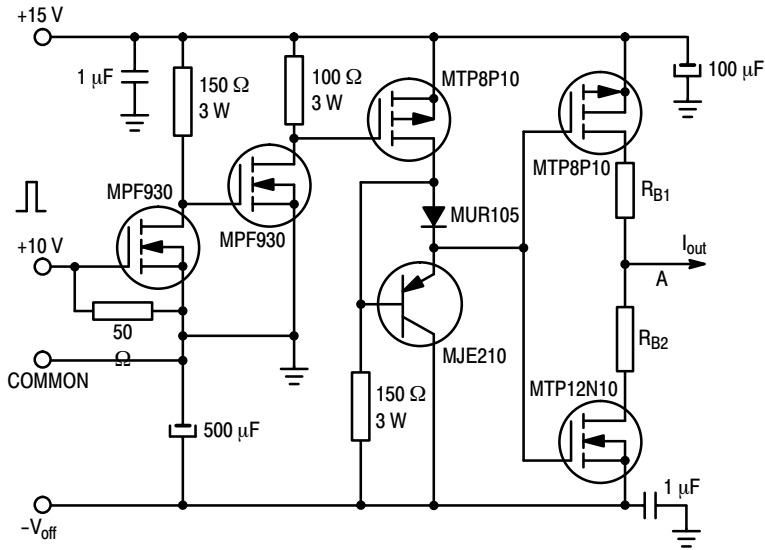

Figure 26. Inductive Switching Measurements

BUD42D

TYPICAL SWITCHING CHARACTERISTICS

Table 1. Inductive Load Switching Drive Circuit



$V_{(BR)CEO(sus)}$
 $L = 10 \text{ mH}$
 $R_{B2} = \infty$
 $V_{CC} = 20 \text{ Volts}$
 $I_{C(pk)} = 100 \text{ mA}$

Inductive Switching
 $L = 200 \mu\text{H}$
 $R_{B2} = 0$
 $V_{CC} = 15 \text{ Volts}$
 R_{B1} selected for desired I_{B1}

RBSOA
 $L = 500 \mu\text{H}$
 $R_{B2} = 0$
 $V_{CC} = 15 \text{ Volts}$
 R_{B1} selected for desired I_{B1}

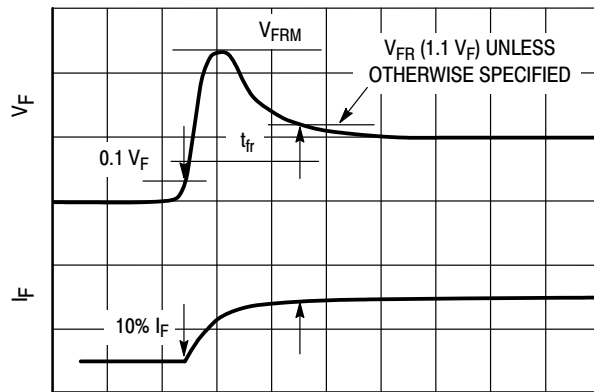

Figure 27. t_{fr} Measurement

BUD42D

MAXIMUM RATINGS

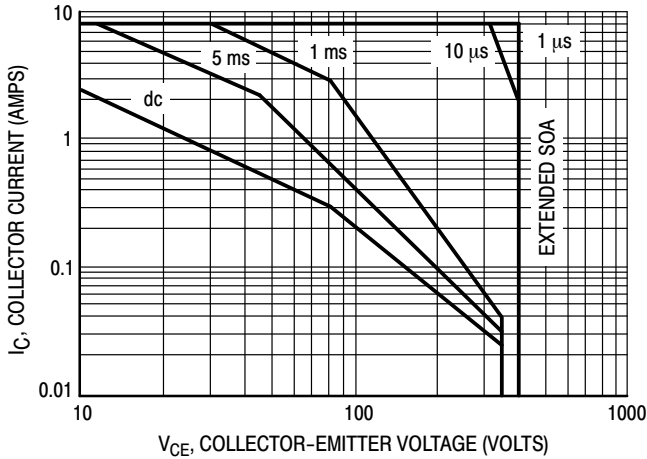

Figure 28. Forward Bias Safe Operating Area

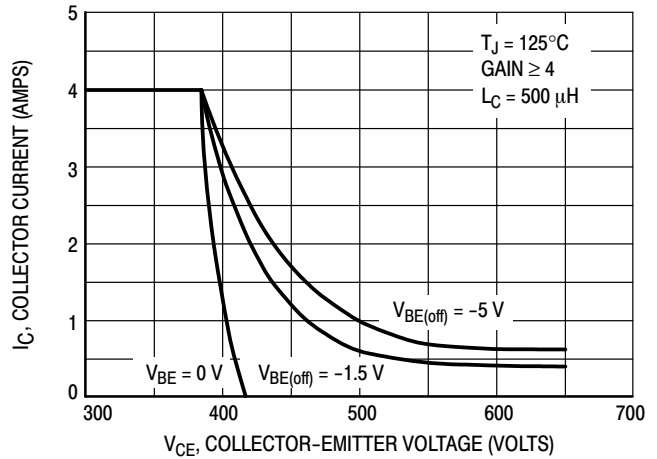

Figure 29. Reverse Bias Safe Operating Area

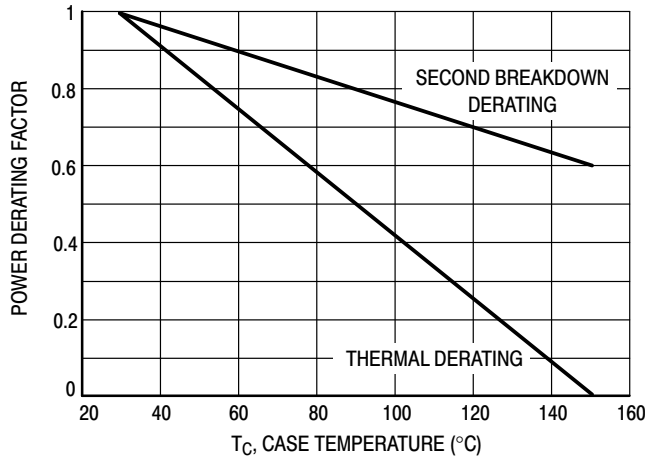

Figure 30. Power Derating

There are two limitations on the power handling ability of a transistor: average junction temperature and second breakdown. Safe operating area curves indicate I_C - V_{CE} limits of the transistor that must be observed for reliable operation; i.e., the transistor must not be subjected to greater dissipation than the curves indicate. The data of Figure 28 is based on $T_C = 25^\circ\text{C}$; $T_{j(pk)}$ is variable depending on power level. Second breakdown pulse limits are valid for duty cycles to 10% but must be derated when $T_C > 25^\circ\text{C}$. Second Breakdown limitations do not derate like thermal limitations. Allowable current at the voltages shown on

Figure 28 may be found at any case temperature by using the appropriate curve on Figure 30.

$T_{j(pk)}$ may be calculated from the data in Figure 31. At any case temperatures, thermal limitations will reduce the power that can be handled to values less than the limitations imposed by second breakdown. For inductive loads, high voltage and current must be sustained simultaneously during turn-off with the base to emitter junction reverse biased. The safe level is specified as reverse biased safe operating area (Figure 29). This rating is verified under clamped conditions so that the device is never subjected to an avalanche mode.

BUD42D

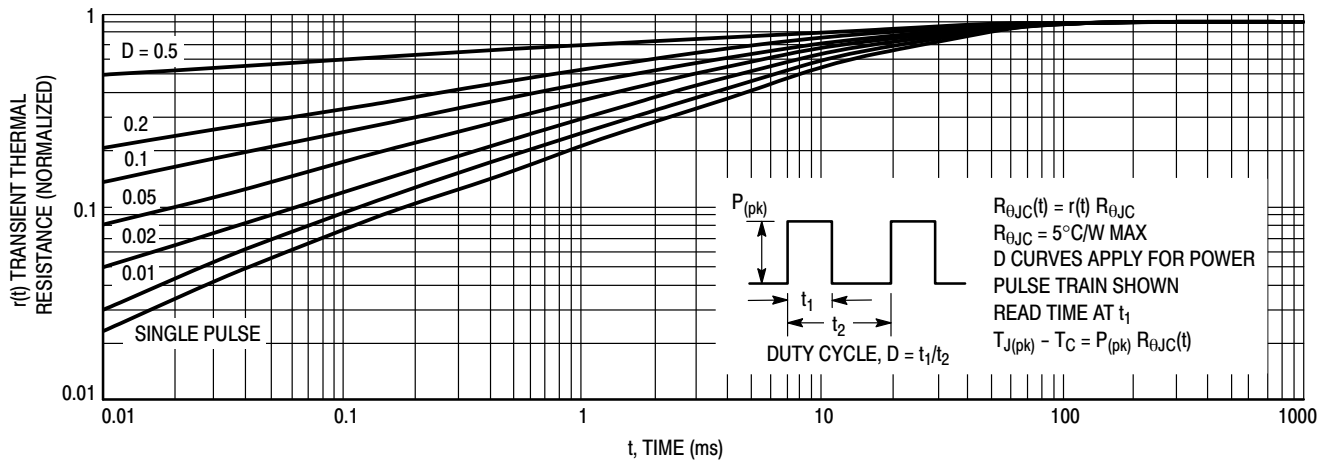

Figure 31. Thermal Response

ORDERING INFORMATION

Device	Package	Shipping†
BUD42D-1G	DPAK Straight Lead (Pb-Free)	75 Units / Rail
BUD42DT4G	DPAK (Pb-Free)	2500 Units / Tape & Reel

†For information on tape and reel specifications, including part orientation and tape sizes, please refer to our Tape and Reel Packaging Specifications Brochure, BRD8011/D.

MECHANICAL CASE OUTLINE

PACKAGE DIMENSIONS

ON Semiconductor®

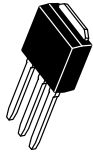

IPAK CASE 369D-01 ISSUE C

DATE 15 DEC 2010

SCALE 1:1

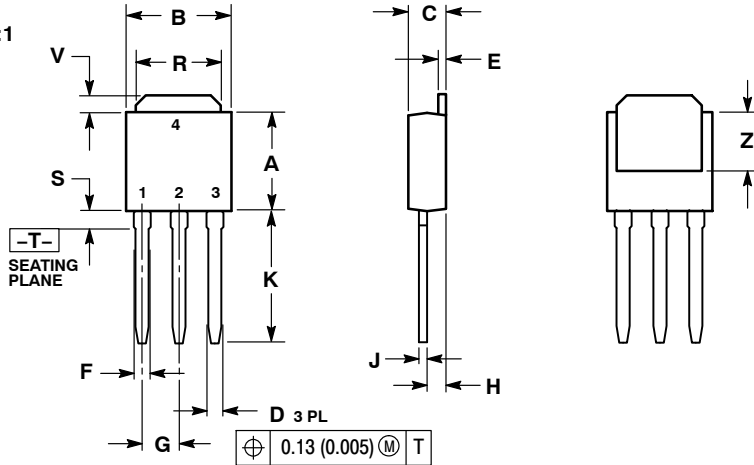

- NOTES:
1. DIMENSIONING AND TOLERANCING PER ANSI Y14.5M, 1982.
 2. CONTROLLING DIMENSION: INCH.

DIM	INCHES		MILLIMETERS	
	MIN	MAX	MIN	MAX
A	0.235	0.245	5.97	6.35
B	0.250	0.265	6.35	6.73
C	0.086	0.094	2.19	2.38
D	0.027	0.035	0.69	0.88
E	0.018	0.023	0.46	0.58
F	0.037	0.045	0.94	1.14
G	0.090	BSC	2.29	BSC
H	0.034	0.040	0.87	1.01
J	0.018	0.023	0.46	0.58
K	0.350	0.380	8.89	9.65
R	0.180	0.215	4.45	5.45
S	0.025	0.040	0.63	1.01
V	0.035	0.050	0.89	1.27
Z	0.155	---	3.93	---

- STYLE 1:
PIN 1. BASE
2. COLLECTOR
3. EMITTER
4. COLLECTOR
- STYLE 2:
PIN 1. GATE
2. DRAIN
3. SOURCE
4. DRAIN
- STYLE 3:
PIN 1. ANODE
2. CATHODE
3. ANODE
4. CATHODE
- STYLE 4:
PIN 1. CATHODE
2. ANODE
3. GATE
4. ANODE
- STYLE 5:
PIN 1. GATE
2. ANODE
3. CATHODE
4. ANODE
- STYLE 6:
PIN 1. MT1
2. MT2
3. GATE
4. MT2
- STYLE 7:
PIN 1. GATE
2. COLLECTOR
3. EMITTER
4. COLLECTOR

MARKING DIAGRAMS

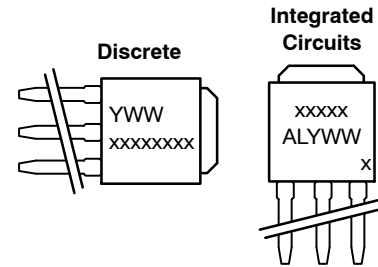

- xxxxxxxxx = Device Code
A = Assembly Location
IL = Wafer Lot
Y = Year
WW = Work Week

DOCUMENT NUMBER:	98AON10528D	Electronic versions are uncontrolled except when accessed directly from the Document Repository. Printed versions are uncontrolled except when stamped "CONTROLLED COPY" in red.
DESCRIPTION:	IPAK (DPAK INSERTION MOUNT)	PAGE 1 OF 1

ON Semiconductor and are trademarks of Semiconductor Components Industries, LLC dba ON Semiconductor or its subsidiaries in the United States and/or other countries. ON Semiconductor reserves the right to make changes without further notice to any products herein. ON Semiconductor makes no warranty, representation or guarantee regarding the suitability of its products for any particular purpose, nor does ON Semiconductor assume any liability arising out of the application or use of any product or circuit, and specifically disclaims any and all liability, including without limitation special, consequential or incidental damages. ON Semiconductor does not convey any license under its patent rights nor the rights of others.

MECHANICAL CASE OUTLINE PACKAGE DIMENSIONS

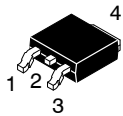

DPAK (SINGLE GAUGE) CASE 369C ISSUE G

DATE 31 MAY 2023

SCALE 1:1

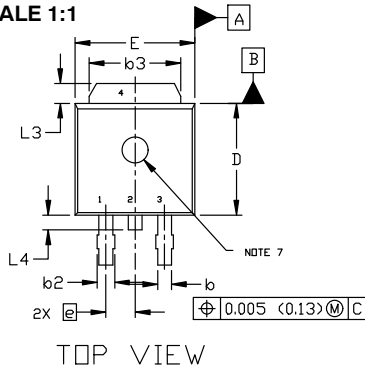

TOP VIEW

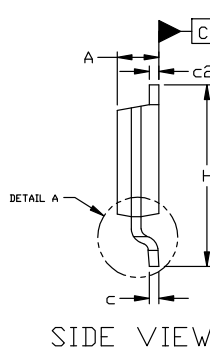

SIDE VIEW

NOTES:

1. DIMENSIONING AND TOLERANCING ASME Y14.5M, 1994.
2. CONTROLLING DIMENSION: INCHES
3. THERMAL PAD CONTOUR OPTIONAL WITHIN DIMENSIONS b3, L3, AND Z.
4. DIMENSIONS D AND E DO NOT INCLUDE MOLD FLASH, PROTRUSIONS, OR BURRS. MOLD FLASH, PROTRUSIONS, OR GATE BURRS SHALL NOT EXCEED 0.006 INCHES PER SIDE.
5. DIMENSIONS D AND E ARE DETERMINED AT THE OUTERMOST EXTREMES OF THE PLASTIC BODY.
6. DATUMS A AND B ARE DETERMINED AT DATUM PLANE H.
7. OPTIONAL MOLD FEATURE.

DIM	INCHES		MILLIMETERS	
	MIN.	MAX.	MIN.	MAX.
A	0.086	0.094	2.18	2.38
A1	0.000	0.005	0.00	0.13
b	0.025	0.035	0.63	0.89
b2	0.028	0.045	0.72	1.14
b3	0.180	0.215	4.57	5.46
c	0.018	0.024	0.46	0.61
c2	0.018	0.024	0.46	0.61
D	0.235	0.245	5.97	6.22
E	0.250	0.265	6.35	6.73
e	0.090	BSC	2.29	BSC
H	0.370	0.410	9.40	10.41
L	0.055	0.070	1.40	1.78
L1	0.114	REF	2.90	REF
L2	0.020	BSC	0.51	BSC
L3	0.035	0.050	0.89	1.27
L4	----	0.040	---	1.01
Z	0.155	----	3.93	---

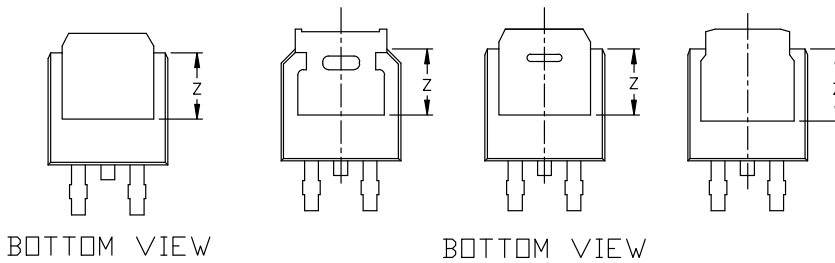

BOTTOM VIEW

BOTTOM VIEW

ALTERNATE CONSTRUCTIONS

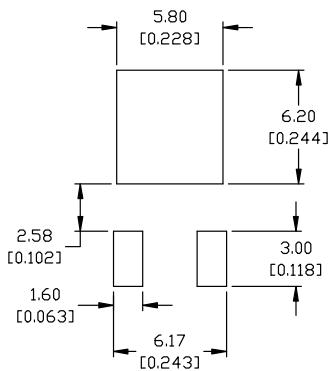

RECOMMENDED MOUNTING FOOTPRINT*

*FOR ADDITIONAL INFORMATION ON OUR Pb-FREE STRATEGY AND SOLDERING DETAILS, PLEASE DOWNLOAD THE ON SEMICONDUCTOR SOLDERING AND MOUNTING TECHNIQUES REFERENCE MANUAL, SOLDERM/D.

- | | | | | |
|--|--|---|---|--|
| <p>STYLE 1:
PIN 1. BASE
2. COLLECTOR
3. EMITTER
4. COLLECTOR</p> | <p>STYLE 2:
PIN 1. GATE
2. DRAIN
3. SOURCE
4. DRAIN</p> | <p>STYLE 3:
PIN 1. ANODE
2. CATHODE
3. ANODE
4. CATHODE</p> | <p>STYLE 4:
PIN 1. CATHODE
2. ANODE
3. GATE
4. ANODE</p> | <p>STYLE 5:
PIN 1. GATE
2. ANODE
3. CATHODE
4. ANODE</p> |
| <p>STYLE 6:
PIN 1. MT1
2. MT2
3. GATE
4. MT2</p> | <p>STYLE 7:
PIN 1. GATE
2. COLLECTOR
3. EMITTER
4. COLLECTOR</p> | <p>STYLE 8:
PIN 1. N/C
2. CATHODE
3. ANODE
4. CATHODE</p> | <p>STYLE 9:
PIN 1. ANODE
2. CATHODE
3. RESISTOR ADJUST
4. CATHODE</p> | <p>STYLE 10:
PIN 1. CATHODE
2. ANODE
3. CATHODE
4. ANODE</p> |

GENERIC MARKING DIAGRAM*

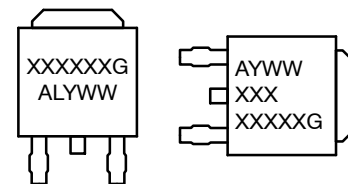

IC

Discrete

- XXXXXX = Device Code
- A = Assembly Location
- L = Wafer Lot
- Y = Year
- WW = Work Week
- G = Pb-Free Package

*This information is generic. Please refer to device data sheet for actual part marking. Pb-Free indicator, "G" or microdot "•", may or may not be present. Some products may not follow the Generic Marking.

DOCUMENT NUMBER:	98AON10527D	Electronic versions are uncontrolled except when accessed directly from the Document Repository. Printed versions are uncontrolled except when stamped "CONTROLLED COPY" in red.
DESCRIPTION:	DPAK (SINGLE GAUGE)	PAGE 1 OF 1

onsemi and onsemi are trademarks of Semiconductor Components Industries, LLC dba onsemi or its subsidiaries in the United States and/or other countries. onsemi reserves the right to make changes without further notice to any products herein. onsemi makes no warranty, representation or guarantee regarding the suitability of its products for any particular purpose, nor does onsemi assume any liability arising out of the application or use of any product or circuit, and specifically disclaims any and all liability, including without limitation special, consequential or incidental damages. onsemi does not convey any license under its patent rights nor the rights of others.

onsemi, **Onsemi**, and other names, marks, and brands are registered and/or common law trademarks of Semiconductor Components Industries, LLC dba "**onsemi**" or its affiliates and/or subsidiaries in the United States and/or other countries. **onsemi** owns the rights to a number of patents, trademarks, copyrights, trade secrets, and other intellectual property. A listing of **onsemi**'s product/patent coverage may be accessed at www.onsemi.com/site/pdf/Patent-Marking.pdf. **onsemi** reserves the right to make changes at any time to any products or information herein, without notice. The information herein is provided "as-is" and **onsemi** makes no warranty, representation or guarantee regarding the accuracy of the information, product features, availability, functionality, or suitability of its products for any particular purpose, nor does **onsemi** assume any liability arising out of the application or use of any product or circuit, and specifically disclaims any and all liability, including without limitation special, consequential or incidental damages. Buyer is responsible for its products and applications using **onsemi** products, including compliance with all laws, regulations and safety requirements or standards, regardless of any support or applications information provided by **onsemi**. "Typical" parameters which may be provided in **onsemi** data sheets and/or specifications can and do vary in different applications and actual performance may vary over time. All operating parameters, including "Typicals" must be validated for each customer application by customer's technical experts. **onsemi** does not convey any license under any of its intellectual property rights nor the rights of others. **onsemi** products are not designed, intended, or authorized for use as a critical component in life support systems or any FDA Class 3 medical devices or medical devices with a same or similar classification in a foreign jurisdiction or any devices intended for implantation in the human body. Should Buyer purchase or use **onsemi** products for any such unintended or unauthorized application, Buyer shall indemnify and hold **onsemi** and its officers, employees, subsidiaries, affiliates, and distributors harmless against all claims, costs, damages, and expenses, and reasonable attorney fees arising out of, directly or indirectly, any claim of personal injury or death associated with such unintended or unauthorized use, even if such claim alleges that **onsemi** was negligent regarding the design or manufacture of the part. **onsemi** is an Equal Opportunity/Affirmative Action Employer. This literature is subject to all applicable copyright laws and is not for resale in any manner.

ADDITIONAL INFORMATION

TECHNICAL PUBLICATIONS:

Technical Library: www.onsemi.com/design/resources/technical-documentation
onsemi Website: www.onsemi.com

ONLINE SUPPORT: www.onsemi.com/support

For additional information, please contact your local Sales Representative at www.onsemi.com/support/sales