

# Complementary Silicon Plastic Power Transistors

## 2N6107, 2N6109, 2N6111 (PNP), 2N6288, 2N6292 (NPN)

These devices are designed for use in general-purpose amplifier and switching applications.

### Features

- High DC Current Gain
- High Current Gain – Bandwidth Product
- TO-220 Compact Package
- These Devices are Pb-Free and are RoHS Compliant\*

### MAXIMUM RATINGS (Note 1)

Rating	Symbol	Value	Unit
Collector–Emitter Voltage 2N6111, 2N6288 2N6109 2N6107, 2N6292	$V_{CEO}$	30 50 70	Vdc
Collector–Base Voltage 2N6111, 2N6288 2N6109 2N6107, 2N6292	$V_{CB}$	40 60 80	Vdc
Emitter–Base Voltage	$V_{EB}$	5.0	Vdc
Collector Current – Continuous	$I_C$	7.0	Adc
Collector Current – Peak	$I_{CM}$	10	Adc
Base Current	$I_B$	3.0	Adc
Total Power Dissipation @ $T_C = 25^\circ\text{C}$ Derate above $25^\circ\text{C}$	$P_D$	40 0.32	W W/ $^\circ\text{C}$
Operating and Storage Junction Temperature Range	$T_J, T_{stg}$	-65 to +150	$^\circ\text{C}$

Stresses exceeding those listed in the Maximum Ratings table may damage the device. If any of these limits are exceeded, device functionality should not be assumed, damage may occur and reliability may be affected.

1. Indicates JEDEC Registered Data.

### THERMAL CHARACTERISTICS

Characteristics	Symbol	Max	Unit
Thermal Resistance, Junction-to-Case	$R_{\theta JC}$	3.125	$^\circ\text{C}/\text{W}$

\*For additional information on our Pb-Free strategy and soldering details, please download the onsemi Soldering and Mounting Techniques Reference Manual, SOLDERRM/D.

## 7 AMPERE POWER TRANSISTORS COMPLEMENTARY SILICON 30 – 50 – 70 VOLTS, 40 WATTS

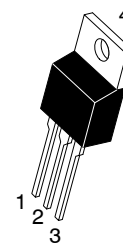
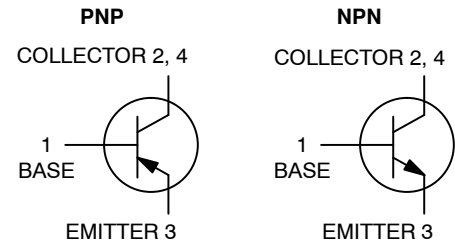

TO-220  
CASE 221A  
STYLE 1

### MARKING DIAGRAM



2N6xxx = Specific Device Code  
xxx = See Table on Page 4  
G = Pb-Free Package  
A = Assembly Location  
Y = Year  
WW = Work Week

### ORDERING INFORMATION

See detailed ordering, marking, and shipping information in the package dimensions section on page 4 of this data sheet.

NOTE: Some of the devices on this data sheet have been **DISCONTINUED**. Please refer to the table on page 4.

## 2N6107, 2N6109, 2N6111 (PNP), 2N6288, 2N6292 (NPN)

### ELECTRICAL CHARACTERISTICS ( $T_C = 25^\circ\text{C}$ unless otherwise noted) (Note 2)

Characteristic	Symbol	Min	Max	Unit
<b>OFF CHARACTERISTICS</b>				
Collector-Emitter Sustaining Voltage (Note 3) ( $I_C = 100\text{ mAdc}$ , $I_B = 0$ ) 2N6111, 2N6288 2N6109 2N6107, 2N6292	$V_{CE(sus)}$	30 50 70	- - -	Vdc
Collector Cutoff Current ( $V_{CE} = 20\text{ Vdc}$ , $I_B = 0$ ) 2N6111, 2N6288 ( $V_{CE} = 40\text{ Vdc}$ , $I_B = 0$ ) 2N6109 ( $V_{CE} = 60\text{ Vdc}$ , $I_B = 0$ ) 2N6107, 2N6292	$I_{CEO}$	- - -	1.0 1.0 1.0	mAdc
Collector Cutoff Current ( $V_{CE} = 40\text{ Vdc}$ , $V_{EB(off)} = 1.5\text{ Vdc}$ ) 2N6111, 2N6288 ( $V_{CE} = 60\text{ Vdc}$ , $V_{EB(off)} = 1.5\text{ Vdc}$ ) 2N6109 ( $V_{CE} = 80\text{ Vdc}$ , $V_{EB(off)} = 1.5\text{ Vdc}$ ) 2N6107, 2N6292 ( $V_{CE} = 30\text{ Vdc}$ , $V_{EB(off)} = 1.5\text{ Vdc}$ , $T_C = 150^\circ\text{C}$ ) 2N6111, 2N6288 ( $V_{CE} = 50\text{ Vdc}$ , $V_{EB(off)} = 1.5\text{ Vdc}$ , $T_C = 150^\circ\text{C}$ ) 2N6109 ( $V_{CE} = 70\text{ Vdc}$ , $V_{EB(off)} = 1.5\text{ Vdc}$ , $T_C = 150^\circ\text{C}$ ) 2N6107, 2N6292	$I_{CEX}$	- - - - - -	100 100 100 2.0 2.0 2.0	$\mu\text{Adc}$    mAdc
Emitter Cutoff Current ( $V_{BE} = 5.0\text{ Vdc}$ , $I_C = 0$ )	$I_{EBO}$	-	1.0	mAdc

### ON CHARACTERISTICS (Note 3)

DC Current Gain ( $I_C = 2.0\text{ Adc}$ , $V_{CE} = 4.0\text{ Vdc}$ ) 2N6107, 2N6292 ( $I_C = 2.5\text{ Adc}$ , $V_{CE} = 4.0\text{ Vdc}$ ) 2N6109 ( $I_C = 3.0\text{ Adc}$ , $V_{CE} = 4.0\text{ Vdc}$ ) 2N6111, 2N6288 ( $I_C = 7.0\text{ Adc}$ , $V_{CE} = 4.0\text{ Vdc}$ ) All Devices	$h_{FE}$	30 30 30 2.3	150 150 150 -	-
Collector-Emitter Saturation Voltage ( $I_C = 7.0\text{ Adc}$ , $I_B = 3.0\text{ Adc}$ )	$V_{CE(sat)}$	-	3.5	Vdc
Base-Emitter On Voltage ( $I_C = 7.0\text{ Adc}$ , $V_{CE} = 4.0\text{ Vdc}$ )	$V_{BE(on)}$	-	3.0	Vdc

### DYNAMIC CHARACTERISTICS

Current Gain – Bandwidth Product (Note 4) ( $I_C = 500\text{ mAdc}$ , $V_{CE} = 4.0\text{ Vdc}$ , $f_{test} = 1.0\text{ MHz}$ ) 2N6288, 2N6292 2N6107, 2N6109, 2N6111	$f_T$	4.0 10	- -	MHz
Output Capacitance ( $V_{CB} = 10\text{ Vdc}$ , $I_E = 0$ , $f = 1.0\text{ MHz}$ )	$C_{ob}$	-	250	pF
Small-Signal Current Gain ( $I_C = 0.5\text{ Adc}$ , $V_{CE} = 4.0\text{ Vdc}$ , $f = 50\text{ kHz}$ )	$h_{fe}$	20	-	-

Product parametric performance is indicated in the Electrical Characteristics for the listed test conditions, unless otherwise noted. Product performance may not be indicated by the Electrical Characteristics if operated under different conditions.

2. Indicates JEDEC Registered Data.

3. Pulse Test: Pulse Width  $\leq 300\ \mu\text{s}$ , Duty Cycle  $\leq 2.0\%$ .

4.  $f_T = |h_{fe}| \cdot f_{test}$

2N6107, 2N6109, 2N6111 (PNP), 2N6288, 2N6292 (NPN)

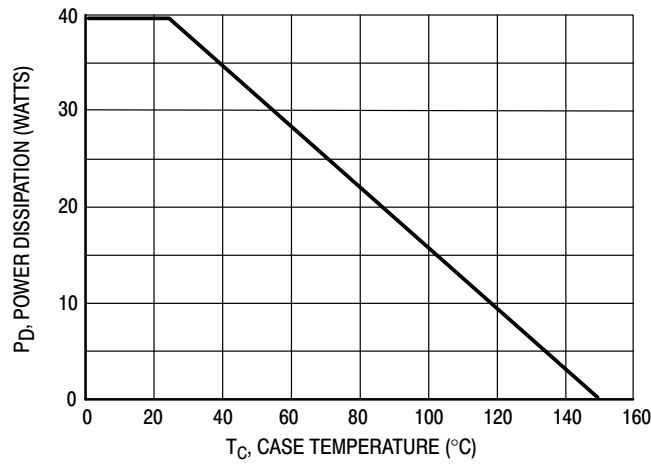

Figure 1. Power Derating

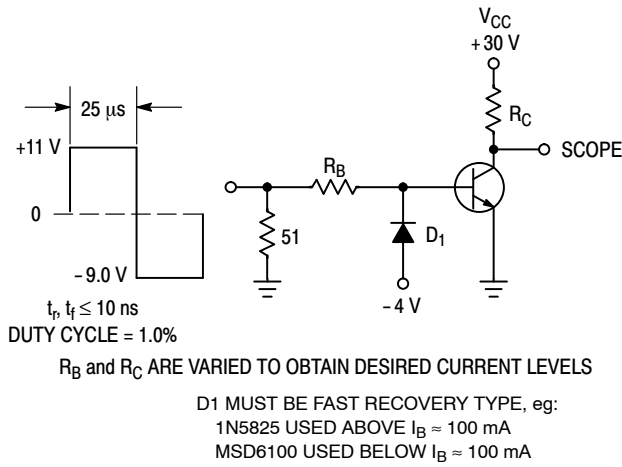

Figure 2. Switching Time Test Circuit

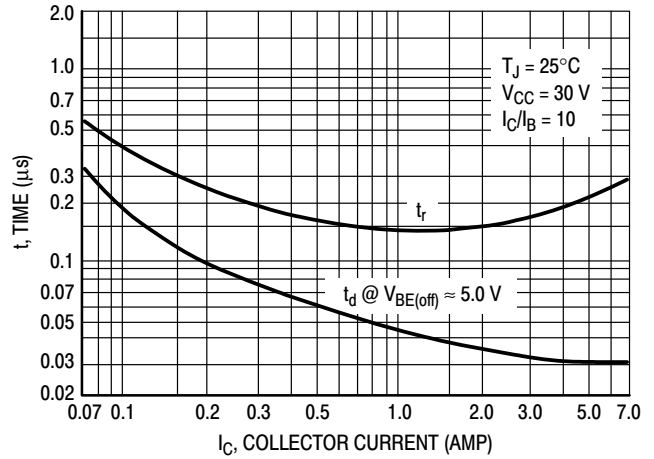

Figure 3. Turn-On Time

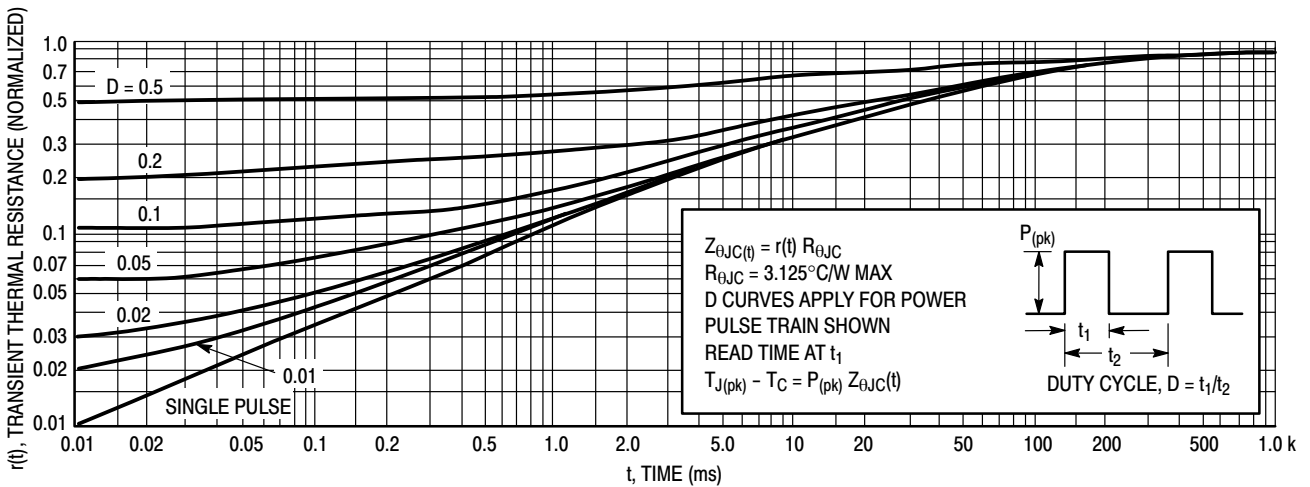
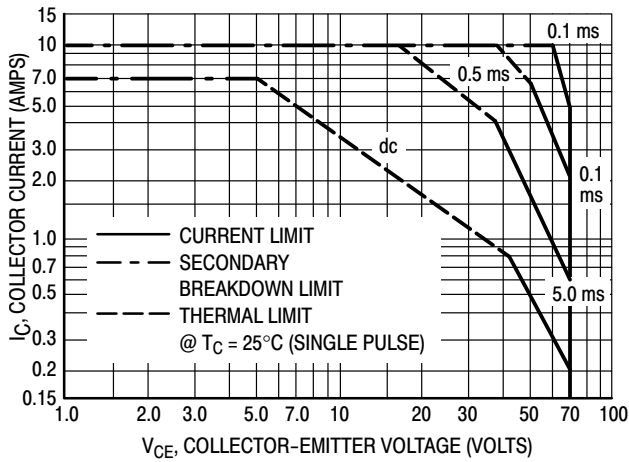

Figure 4. Thermal Response

## 2N6107, 2N6109, 2N6111 (PNP), 2N6288, 2N6292 (NPN)



**Figure 5. Active-Region Safe Operating Area**

There are two limitations on the power handling ability of a transistor: average junction temperature and second breakdown. Safe operating area curves indicate  $I_C - V_{CE}$  limits of the transistor that must be observed for reliable operation; i.e., the transistor must not be subjected to greater dissipation than the curves indicate.

The data of Figure 5 is based on  $T_{J(pk)} = 150^\circ\text{C}$ ;  $T_C$  is variable depending on conditions. Second breakdown pulse limits are valid for duty cycles to 10% provided  $T_{J(pk)} \leq 150^\circ\text{C}$ .  $T_{J(pk)}$  may be calculated from the data in Figure 4. At high case temperatures, thermal limitations will reduce the power that can be handled to values less than the limitations imposed by second breakdown.

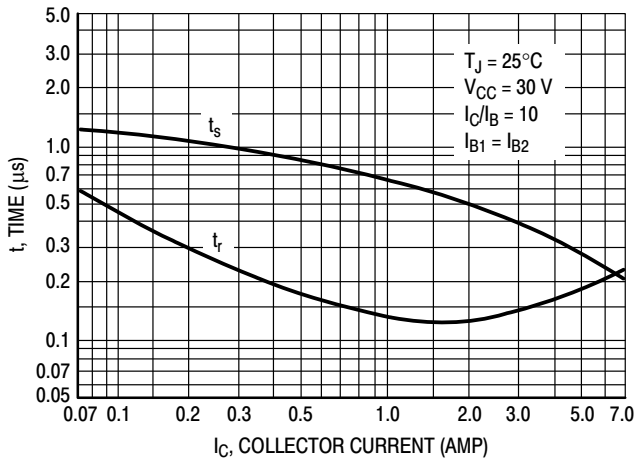

**Figure 6. Turn-Off Time**

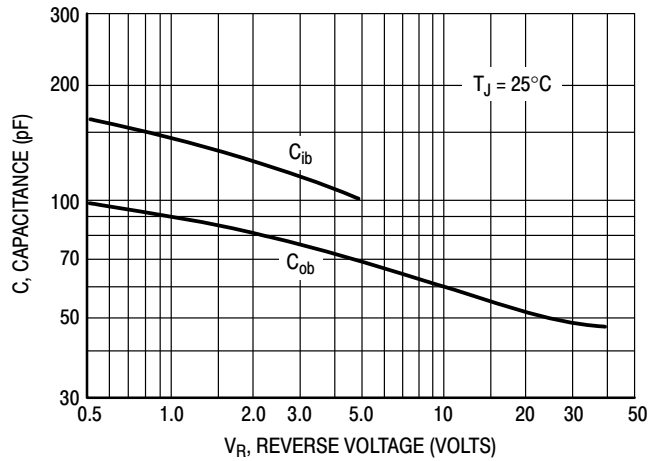

**Figure 7. Capacitance**

### ORDERING INFORMATION

Device	Device Marking	Package	Shipping
2N6292G	2N6292	TO-220 (Pb-Free)	50 Units / Rail

### DISCONTINUED (Note 5)

2N6107G	2N6107	TO-220 (Pb-Free)	50 Units / Rail
2N6109G	2N6109	TO-220 (Pb-Free)	50 Units / Rail
2N6111G	2N6111	TO-220 (Pb-Free)	50 Units / Rail
2N6288G	2N6288	TO-220 (Pb-Free)	50 Units / Rail

5. **DISCONTINUED:** These devices are not recommended for new design. Please contact your **onsemi** representative for information. The most current information on these devices may be available on [www.onsemi.com](http://www.onsemi.com).

**onsemi**, **Onsemi**, and other names, marks, and brands are registered and/or common law trademarks of Semiconductor Components Industries, LLC dba "**onsemi**" or its affiliates and/or subsidiaries in the United States and/or other countries. **onsemi** owns the rights to a number of patents, trademarks, copyrights, trade secrets, and other intellectual property. A listing of **onsemi**'s product/patent coverage may be accessed at [www.onsemi.com/site/pdf/Patent-Marking.pdf](http://www.onsemi.com/site/pdf/Patent-Marking.pdf). **onsemi** reserves the right to make changes at any time to any products or information herein, without notice. The information herein is provided "as-is" and **onsemi** makes no warranty, representation or guarantee regarding the accuracy of the information, product features, availability, functionality, or suitability of its products for any particular purpose, nor does **onsemi** assume any liability arising out of the application or use of any product or circuit, and specifically disclaims any and all liability, including without limitation special, consequential or incidental damages. Buyer is responsible for its products and applications using **onsemi** products, including compliance with all laws, regulations and safety requirements or standards, regardless of any support or applications information provided by **onsemi**. "Typical" parameters which may be provided in **onsemi** data sheets and/or specifications can and do vary in different applications and actual performance may vary over time. All operating parameters, including "Typicals" must be validated for each customer application by customer's technical experts. **onsemi** does not convey any license under any of its intellectual property rights nor the rights of others. **onsemi** products are not designed, intended, or authorized for use as a critical component in life support systems or any FDA Class 3 medical devices or medical devices with a same or similar classification in a foreign jurisdiction or any devices intended for implantation in the human body. Should Buyer purchase or use **onsemi** products for any such unintended or unauthorized application, Buyer shall indemnify and hold **onsemi** and its officers, employees, subsidiaries, affiliates, and distributors harmless against all claims, costs, damages, and expenses, and reasonable attorney fees arising out of, directly or indirectly, any claim of personal injury or death associated with such unintended or unauthorized use, even if such claim alleges that **onsemi** was negligent regarding the design or manufacture of the part. **onsemi** is an Equal Opportunity/Affirmative Action Employer. This literature is subject to all applicable copyright laws and is not for resale in any manner.

## ADDITIONAL INFORMATION

### TECHNICAL PUBLICATIONS:

Technical Library: [www.onsemi.com/design/resources/technical-documentation](http://www.onsemi.com/design/resources/technical-documentation)  
onsemi Website: [www.onsemi.com](http://www.onsemi.com)

### ONLINE SUPPORT: [www.onsemi.com/support](http://www.onsemi.com/support)

For additional information, please contact your local Sales Representative at [www.onsemi.com/support/sales](http://www.onsemi.com/support/sales)