

2N5655G, 2N5657G

Plastic NPN Silicon High-Voltage Power Transistors

These devices are designed for use in line-operated equipment such as audio output amplifiers; low-current, high-voltage converters; and AC line relays.

Features

- Excellent DC Current Gain
- High Current-Gain – Bandwidth Product
- These Devices are Pb-Free and are RoHS Compliant*

MAXIMUM RATINGS (Note 1)

Rating	Symbol	Value	Unit
Collector-Emitter Voltage 2N5655G 2N5657G	V_{CEO}	250 350	Vdc
Collector-Base Voltage 2N5655G 2N5657G	V_{CB}	275 375	Vdc
Emitter-Base Voltage	V_{EB}	6.0	Vdc
Collector Current – Continuous	I_C	0.5	Adc
Collector Current – Peak	I_{CM}	1.0	Adc
Base Current	I_B	1.0	Adc
Total Device Dissipation @ $T_C = 25^\circ\text{C}$ Derate above 25°C	P_D	20 0.16	W W/ $^\circ\text{C}$
Operating and Storage Junction Temperature Range	T_J, T_{stg}	-65 to +150	$^\circ\text{C/W}$

Stresses exceeding those listed in the Maximum Ratings table may damage the device. If any of these limits are exceeded, device functionality should not be assumed, damage may occur and reliability may be affected.

1. Indicates JEDEC registered data.

THERMAL CHARACTERISTICS

Characteristic	Symbol	Max	Unit
Thermal Resistance, Junction-to-Case	$R_{\theta JC}$	6.25	$^\circ\text{C/W}$

*For additional information on our Pb-Free strategy and soldering details, please download the ON Semiconductor Soldering and Mounting Techniques Reference Manual, SOLDERRM/D.



ON Semiconductor®

<http://onsemi.com>

**0.5 AMPERE
POWER TRANSISTORS
NPN SILICON
250-350 VOLTS, 20 WATTS**

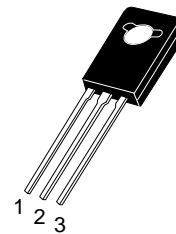
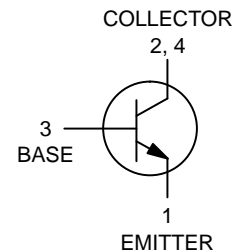

**TO-225
CASE 77-09
STYLE 1**

MARKING DIAGRAM

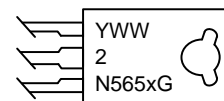

Y = Year
 WW = Work Week
 2N565x = Device Code
 x = 5 or 7
 G = Pb-Free Package

ORDERING INFORMATION

Device	Package	Shipping
2N5655G	TO-225 (Pb-Free)	500 Units / Bulk
2N5657G	TO-225 (Pb-Free)	500 Units / Bulk

2N5655G, 2N5657G

ELECTRICAL CHARACTERISTICS ($T_C = 25^\circ\text{C}$ unless otherwise noted) (Note 2)

Characteristic	Symbol	Min	Max	Unit
OFF CHARACTERISTICS				
Collector–Emitter Sustaining Voltage ($I_C = 100\text{ mAdc}$ (inductive), $L = 50\text{ mH}$) 2N5655G 2N5657G	$V_{CE(sus)}$	250 350	– –	Vdc
Collector–Emitter Breakdown Voltage ($I_C = 1.0\text{ mAdc}$, $I_B = 0$) 2N5655G 2N5657G	$V_{(BR)CEO}$	250 350	– –	Vdc
Collector Cutoff Current ($V_{CE} = 150\text{ Vdc}$, $I_B = 0$) 2N5655G ($V_{CE} = 250\text{ Vdc}$, $I_B = 0$) 2N5657G	I_{CEO}	– –	0.1 0.1	mAdc
Collector Cutoff Current ($V_{CE} = 250\text{ Vdc}$, $V_{EB(off)} = 1.5\text{ Vdc}$) 2N5655G ($V_{CE} = 350\text{ Vdc}$, $V_{EB(off)} = 1.5\text{ Vdc}$) 2N5657G ($V_{CE} = 150\text{ Vdc}$, $V_{EB(off)} = 1.5\text{ Vdc}$, $T_C = 100^\circ\text{C}$) 2N5655G ($V_{CE} = 250\text{ Vdc}$, $V_{EB(off)} = 1.5\text{ Vdc}$, $T_C = 100^\circ\text{C}$) 2N5657G	I_{CEX}	– – – –	0.1 0.1 1.0 1.0	mAdc
Collector Cutoff Current ($V_{CB} = 275\text{ Vdc}$, $I_E = 0$) 2N5655G ($V_{CB} = 375\text{ Vdc}$, $I_E = 0$) 2N5657G	I_{CBO}	– –	10 10	μAdc
Emitter Cutoff Current ($V_{EB} = 6.0\text{ Vdc}$, $I_C = 0$)	I_{EBO}	–	10	μAdc

ON CHARACTERISTICS

DC Current Gain (Note 3) ($I_C = 50\text{ mAdc}$, $V_{CE} = 10\text{ Vdc}$) ($I_C = 100\text{ mAdc}$, $V_{CE} = 10\text{ Vdc}$) ($I_C = 250\text{ mAdc}$, $V_{CE} = 10\text{ Vdc}$) ($I_C = 500\text{ mAdc}$, $V_{CE} = 10\text{ Vdc}$)	h_{FE}	25 30 15 5.0	– 250 – –	–
Collector–Emitter Saturation Voltage (Note 3) ($I_C = 100\text{ mAdc}$, $I_B = 10\text{ mAdc}$) ($I_C = 250\text{ mAdc}$, $I_B = 25\text{ mAdc}$) ($I_C = 500\text{ mAdc}$, $I_B = 100\text{ mAdc}$)	$V_{CE(sat)}$	– – –	1.0 2.5 10	Vdc
Base–Emitter Voltage ($I_C = 100\text{ mAdc}$, $V_{CE} = 10\text{ Vdc}$) (Note 3)	V_{BE}	–	1.0	Vdc

DYNAMIC CHARACTERISTICS

Current–Gain – Bandwidth Product ($I_C = 50\text{ mAdc}$, $V_{CE} = 10\text{ Vdc}$, $f = 10\text{ MHz}$) (Note 4)	f_T	10	–	MHz
Output Capacitance ($V_{CB} = 10\text{ Vdc}$, $I_E = 0$, $f = 100\text{ kHz}$)	C_{ob}	–	25	pF
Small–Signal Current Gain ($I_C = 100\text{ mAdc}$, $V_{CE} = 10\text{ Vdc}$, $f = 1.0\text{ kHz}$)	h_{fe}	20	–	–

Product parametric performance is indicated in the Electrical Characteristics for the listed test conditions, unless otherwise noted. Product performance may not be indicated by the Electrical Characteristics if operated under different conditions.

2. Indicates JEDEC registered data for 2N5655 Series.
3. Pulse Test: Pulse Width $\leq 300\ \mu\text{s}$, Duty Cycle $\leq 2.0\%$.
4. f_T is defined as the frequency at which $|h_{fe}|$ extrapolates to unity.

2N5655G, 2N5657G

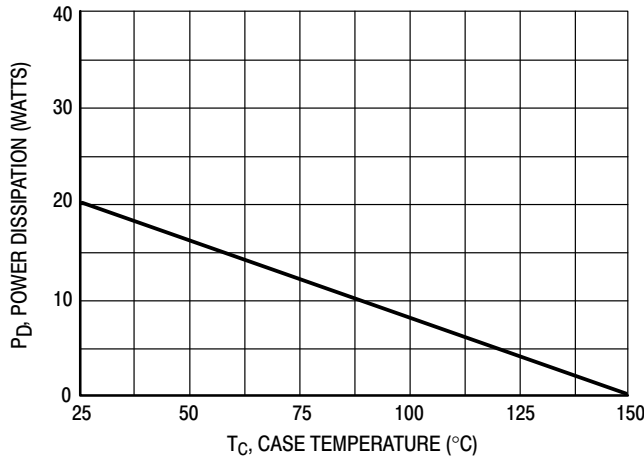

Figure 1. Power Derating

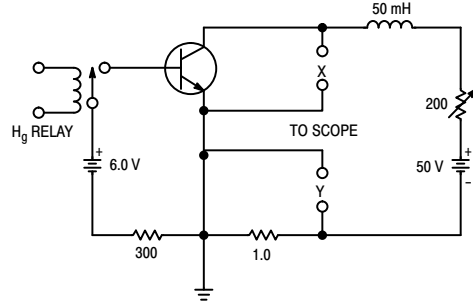

Figure 2. Sustaining Voltage Test Circuit

Safe Area Limits are indicated by Figures 3 and 4. Both limits are applicable and must be observed.

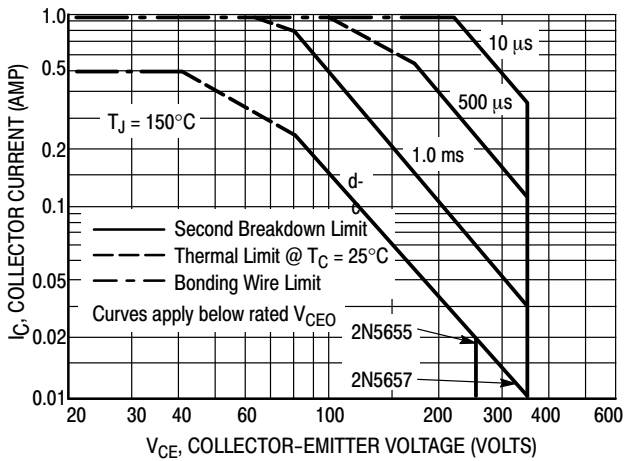

Figure 3. Active-Region Safe Operating Area

There are two limitations on the power handling ability of a transistor: average junction temperature and second breakdown. Safe operating area curves indicate $I_C - V_{CE}$ limits of the transistor that must be observed for reliable operation; i.e., the transistor must not be subjected to greater dissipation than the curves indicate.

The data of Figure 3 is based on $T_{J(pk)} = 150^\circ\text{C}$; T_C is variable depending on conditions. Second breakdown pulse limits are valid for duty cycles to 10% provided $T_{J(pk)} \leq 150^\circ\text{C}$. At high case temperatures, thermal limitations will reduce the power that can be handled to values less than the limitations imposed by second breakdown.

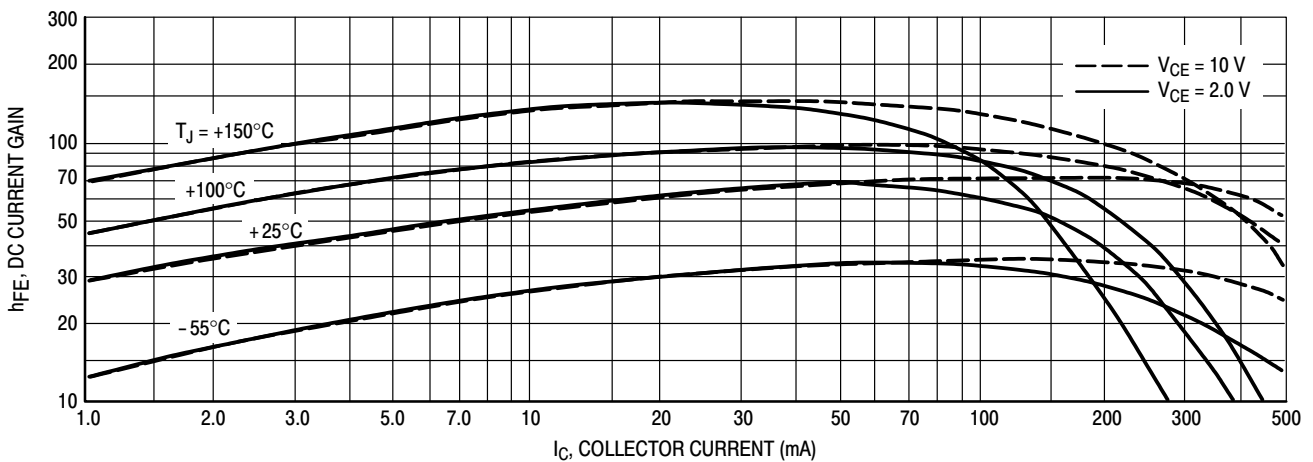

Figure 4. Current Gain

2N5655G, 2N5657G

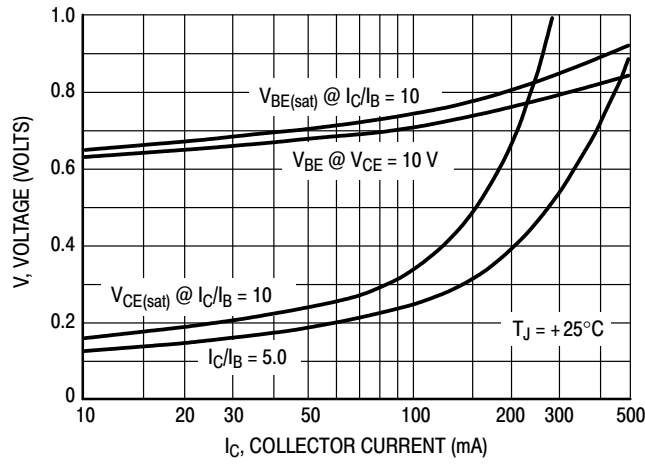

Figure 5. "On" Voltages

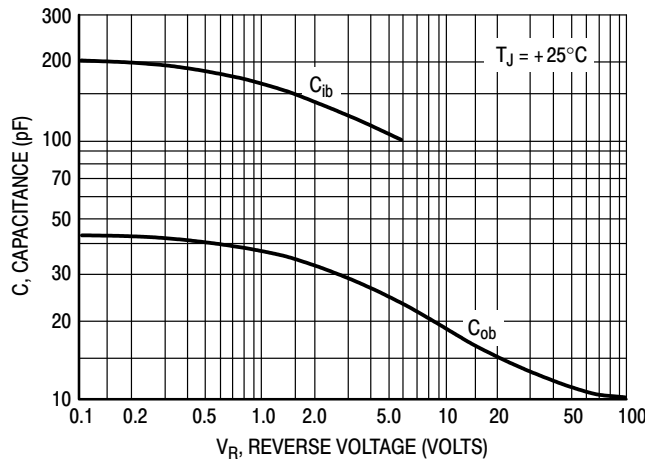

Figure 6. Capacitance

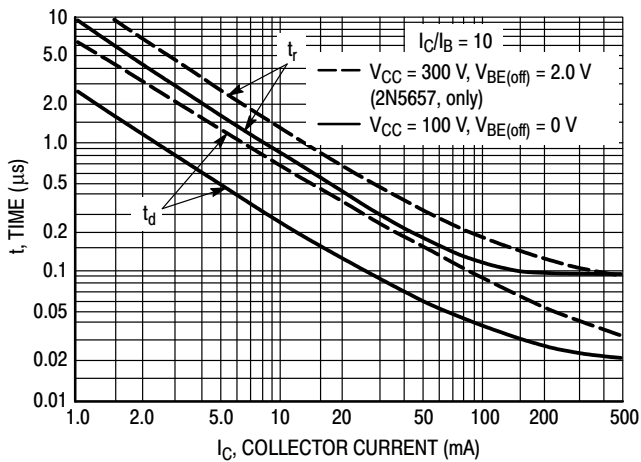

Figure 7. Turn-On Time

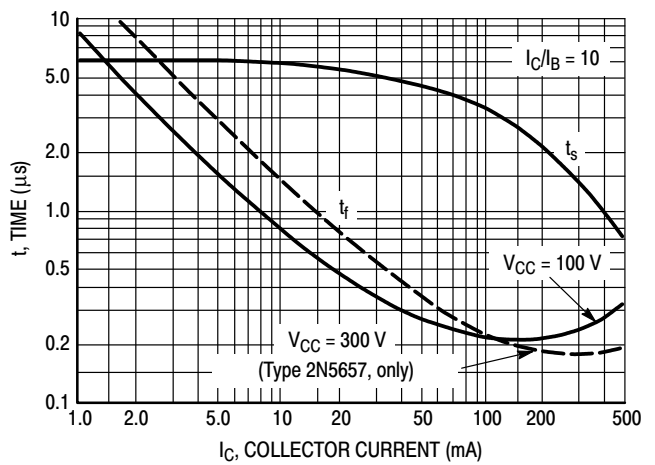
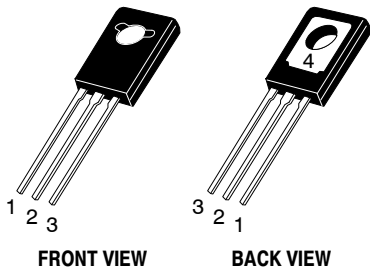

Figure 8. Turn-Off Time

MECHANICAL CASE OUTLINE

PACKAGE DIMENSIONS

ON Semiconductor®



TO-225
CASE 77-09
ISSUE AD

DATE 25 MAR 2015

SCALE 1:1

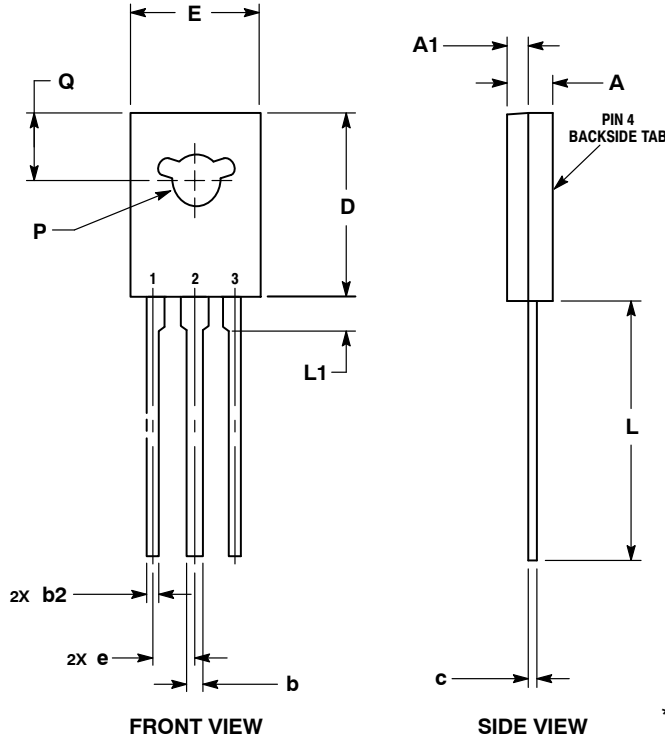

NOTES:

1. DIMENSIONING AND TOLERANCING PER ASME Y14.5M, 1994.
2. CONTROLLING DIMENSION: MILLIMETERS.
3. NUMBER AND SHAPE OF LUGS OPTIONAL.

DIM	MILLIMETERS	
	MIN	MAX
A	2.40	3.00
A1	1.00	1.50
b	0.60	0.90
b2	0.51	0.88
c	0.39	0.63
D	10.60	11.10
E	7.40	7.80
e	2.04	2.54
L	14.50	16.63
L1	1.27	2.54
P	2.90	3.30
Q	3.80	4.20

GENERIC MARKING DIAGRAM*

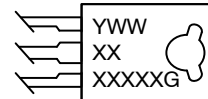

- Y = Year
- WW = Work Week
- XXXXX = Device Code
- G = Pb-Free Package

*This information is generic. Please refer to device data sheet for actual part marking. Pb-Free indicator, "G" or microdot "•", may or may not be present.

- | | | | | |
|---|---|---|---|---|
| <p>STYLE 1:
PIN 1. EMITTER
2., 4. COLLECTOR
3. BASE</p> | <p>STYLE 2:
PIN 1. CATHODE
2., 4. ANODE
3. GATE</p> | <p>STYLE 3:
PIN 1. BASE
2., 4. COLLECTOR
3. EMITTER</p> | <p>STYLE 4:
PIN 1. ANODE 1
2., 4. ANODE 2
3. GATE</p> | <p>STYLE 5:
PIN 1. MT 1
2., 4. MT 2
3. GATE</p> |
| <p>STYLE 6:
PIN 1. CATHODE
2., 4. GATE
3. ANODE</p> | <p>STYLE 7:
PIN 1. MT 1
2., 4. GATE
3. MT 2</p> | <p>STYLE 8:
PIN 1. SOURCE
2., 4. GATE
3. DRAIN</p> | <p>STYLE 9:
PIN 1. GATE
2., 4. DRAIN
3. SOURCE</p> | <p>STYLE 10:
PIN 1. SOURCE
2., 4. DRAIN
3. GATE</p> |

DOCUMENT NUMBER:	98ASB42049B	Electronic versions are uncontrolled except when accessed directly from the Document Repository. Printed versions are uncontrolled except when stamped "CONTROLLED COPY" in red.
DESCRIPTION:	TO-225	PAGE 1 OF 1

ON Semiconductor and are trademarks of Semiconductor Components Industries, LLC dba ON Semiconductor or its subsidiaries in the United States and/or other countries. ON Semiconductor reserves the right to make changes without further notice to any products herein. ON Semiconductor makes no warranty, representation or guarantee regarding the suitability of its products for any particular purpose, nor does ON Semiconductor assume any liability arising out of the application or use of any product or circuit, and specifically disclaims any and all liability, including without limitation special, consequential or incidental damages. ON Semiconductor does not convey any license under its patent rights nor the rights of others.

onsemi, **Onsemi**, and other names, marks, and brands are registered and/or common law trademarks of Semiconductor Components Industries, LLC dba "**onsemi**" or its affiliates and/or subsidiaries in the United States and/or other countries. **onsemi** owns the rights to a number of patents, trademarks, copyrights, trade secrets, and other intellectual property. A listing of **onsemi**'s product/patent coverage may be accessed at www.onsemi.com/site/pdf/Patent-Marking.pdf. **onsemi** reserves the right to make changes at any time to any products or information herein, without notice. The information herein is provided "as-is" and **onsemi** makes no warranty, representation or guarantee regarding the accuracy of the information, product features, availability, functionality, or suitability of its products for any particular purpose, nor does **onsemi** assume any liability arising out of the application or use of any product or circuit, and specifically disclaims any and all liability, including without limitation special, consequential or incidental damages. Buyer is responsible for its products and applications using **onsemi** products, including compliance with all laws, regulations and safety requirements or standards, regardless of any support or applications information provided by **onsemi**. "Typical" parameters which may be provided in **onsemi** data sheets and/or specifications can and do vary in different applications and actual performance may vary over time. All operating parameters, including "Typicals" must be validated for each customer application by customer's technical experts. **onsemi** does not convey any license under any of its intellectual property rights nor the rights of others. **onsemi** products are not designed, intended, or authorized for use as a critical component in life support systems or any FDA Class 3 medical devices or medical devices with a same or similar classification in a foreign jurisdiction or any devices intended for implantation in the human body. Should Buyer purchase or use **onsemi** products for any such unintended or unauthorized application, Buyer shall indemnify and hold **onsemi** and its officers, employees, subsidiaries, affiliates, and distributors harmless against all claims, costs, damages, and expenses, and reasonable attorney fees arising out of, directly or indirectly, any claim of personal injury or death associated with such unintended or unauthorized use, even if such claim alleges that **onsemi** was negligent regarding the design or manufacture of the part. **onsemi** is an Equal Opportunity/Affirmative Action Employer. This literature is subject to all applicable copyright laws and is not for resale in any manner.

ADDITIONAL INFORMATION

TECHNICAL PUBLICATIONS:

Technical Library: www.onsemi.com/design/resources/technical-documentation
onsemi Website: www.onsemi.com

ONLINE SUPPORT: www.onsemi.com/support

For additional information, please contact your local Sales Representative at www.onsemi.com/support/sales