

ON Semiconductor

Is Now

onsemi™

To learn more about onsemi™, please visit our website at
www.onsemi.com

onsemi and **onsemi** and other names, marks, and brands are registered and/or common law trademarks of Semiconductor Components Industries, LLC dba "**onsemi**" or its affiliates and/or subsidiaries in the United States and/or other countries. **onsemi** owns the rights to a number of patents, trademarks, copyrights, trade secrets, and other intellectual property. A listing of **onsemi** product/patent coverage may be accessed at www.onsemi.com/site/pdf/Patent-Marking.pdf. **onsemi** reserves the right to make changes at any time to any products or information herein, without notice. The information herein is provided "as-is" and **onsemi** makes no warranty, representation or guarantee regarding the accuracy of the information, product features, availability, functionality, or suitability of its products for any particular purpose, nor does **onsemi** assume any liability arising out of the application or use of any product or circuit, and specifically disclaims any and all liability, including without limitation special, consequential or incidental damages. Buyer is responsible for its products and applications using **onsemi** products, including compliance with all laws, regulations and safety requirements or standards, regardless of any support or applications information provided by **onsemi**. "Typical" parameters which may be provided in **onsemi** data sheets and/or specifications can and do vary in different applications and actual performance may vary over time. All operating parameters, including "Typicals" must be validated for each customer application by customer's technical experts. **onsemi** does not convey any license under any of its intellectual property rights nor the rights of others. **onsemi** products are not designed, intended, or authorized for use as a critical component in life support systems or any FDA Class 3 medical devices or medical devices with a same or similar classification in a foreign jurisdiction or any devices intended for implantation in the human body. Should Buyer purchase or use **onsemi** products for any such unintended or unauthorized application, Buyer shall indemnify and hold **onsemi** and its officers, employees, subsidiaries, affiliates, and distributors harmless against all claims, costs, damages, and expenses, and reasonable attorney fees arising out of, directly or indirectly, any claim of personal injury or death associated with such unintended or unauthorized use, even if such claim alleges that **onsemi** was negligent regarding the design or manufacture of the part. **onsemi** is an Equal Opportunity/Affirmative Action Employer. This literature is subject to all applicable copyright laws and is not for resale in any manner. Other names and brands may be claimed as the property of others.



3.3KW On Board EV Charger

ON Semiconductor

| Device | Application | Input Voltage | Output Power | Topology | I/O Isolation |
|---|---------------------|---------------|--------------|--|---------------|
| FAN9672Q FAN7688SJX NCP1340B3D1R2G FAN6224M FAN3224TUMX-F085 NCV890100PDR2G NCV51460SN33T1G NCV210SQT2G NCV2003SN2T1G SC431AVSNT1G FODM8801C ... | On Board EV Charger | 90-264Vac | 3.3KW | 2CH Interleave PFC + Full Bridge LLC + QR Flyback + Buck DCDC | Yes |

Other Specification

| | Output 1 | Output 2 |
|-----------------|------------------------|------------------------|
| Output Voltage | 200-450Vdc | 12Vdc |
| Ripple | 5% (Meet QCT 895 2011) | 1% (Meet QCT 895 2011) |
| Nominal Current | - | - |
| Max Current | 14 | 10 |
| Min Current | 0 | 0.1 |

| | |
|-----------------------|---|
| PFC (Yes/No) | Yes |
| Minimum Efficiency | 90% |
| Inrush Limiting | 24A |
| Operating Temp. Range | -20-85°C |
| Cooling Method | Force Air or Liquid cooling. Depend on the Heatsink |
| Signal Level Control | On/Off, CC, CV. |

Photo Graph of the Evaluation Board

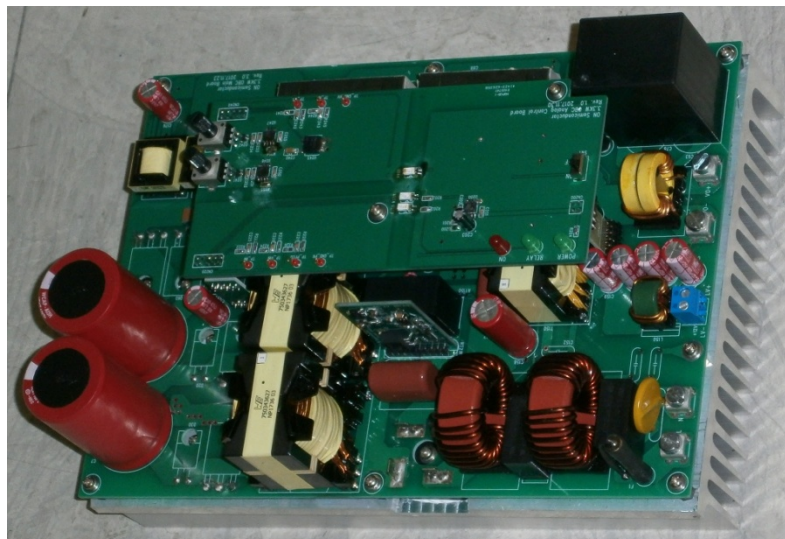

DN05107/D

Key Features

Whole Solution:

- 2CH Interleave PFC to get high efficiency and power density. Decrease the current ripple at mean time
- Full bridge LLC to boost efficiency by high bus voltage usage
- QR flyback to boost the efficiency on the 12V/10A LV output and the auxiliary power
- Hardware PFC and LLC control approach for easily designing and less malfunction.
- Active inrush current limit circuit to decrease the PCB footprint
- Full functional solution including input/output current/voltage sensing and CC/CV PWM control interface. CAN interface will be available on next version

PFC Controller FAN9672

- Continuous Conduction Mode with Average Current Mode Control
- Two-Channel Interleave Operation
- Programmable Operation Frequency Range: 18 kHz~40 kHz or 55 kHz~75 kHz
- Programmable PFC Output Voltage
- Two Current-Limit Functions
- TriFault Detect™ Protects Against Feedback Loop Failure
- SAG Protection
- Programmable Soft-Start
- Under-Voltage Lockout (UVLO)
- Differential Current Sensing

LLC Controller FAN7688

- Secondary Side PFM Controller for LLC Resonant Converter with Synchronous Rectifier Control
- Charge Current Control for Better Transient Response and Easy Feedback Loop Design
- Adaptive Synchronous Rectification Control with Dual Edge Tracking
- Closed Loop Soft-Start for Monotonic Rising Output
- Wide Operating Frequency (39 kHz ~ 690 kHz)
- Green Functions to Improve Light-Load Efficiency
- Symmetric PWM Control at Light-Load to Limit the Switching Frequency while Reducing Switching Losses
- Protection Functions(with Auto-Restart
 - Over-Current Protection (OCP)
 - Output Short Protection (OSP)
 - NON Zero-Voltage Switching Prevention (NZS) by Compensation Cutback (Frequency Shift)
 - Power Limit by Compensation Cutback (Frequency Shift)
 - Overload Protection (OLP) with Programmable Shutdown Delay Time
 - Over-Temperature Protection (OTP)
- Programmable Dead Times for Primary Side Switches and Secondary Side Synchronous Rectifiers
- VDD Under-Voltage Lockout (UVLO)
- Wide Operating Temperature Range -40°C to +125°C

QR PWM Controller NCP1340

- QR Frequency Jittering to Reduces EMI Signature
- New Quiet-Skip Technology Ensures Operation Outside Audible Range
- Integrated HV Startup with Brownout Protection Provides an efficient power-on source and protects against drops in input mains voltage
- Valley Switching Operation with Valley Lockout. Maximizing the efficiency over the entire power range
- Integrated X2 Capacitor Discharge Capability Eliminates the need for a X2 resistors
- NTC Compatible Fault Pin Extra protection against high temperature or other fault conditions
- High Drive Capability: -500 mA / +800 mA Enables faster switching of primary-side MOSFET
- Latch input for OVP and OTP implementations Simple implementation of required protection functions

Synchronous Rectification Controller FAN6224

- mWSaver™ Technology
- Internal Green Mode to Stop SR Switching for Lower No-Load Power Consumption
- 300 μ A Ultra-Low Green Mode Operating Current
- Suited for High-Side and Low-Side of Flyback Converters in QR, DCM, CCM Operation and Forward Freewheeling Rectification
- PWM Frequency Tracking with Secondary-Side Winding Voltage Detection
- 140 kHz Maximum Operation Frequency
- VDD Pin Over-Voltage Protection (OVP)

- LPC Pin Open/Short Protection
- RES Pin Open/Short Protection
- RP Pin Open/Short Protection
- Internal Over-Temperature Protection (OTP)

Schematics and Circuit Description

The system diagram is on Figure 1. The key elements of the OBC are marked in the color blocks.

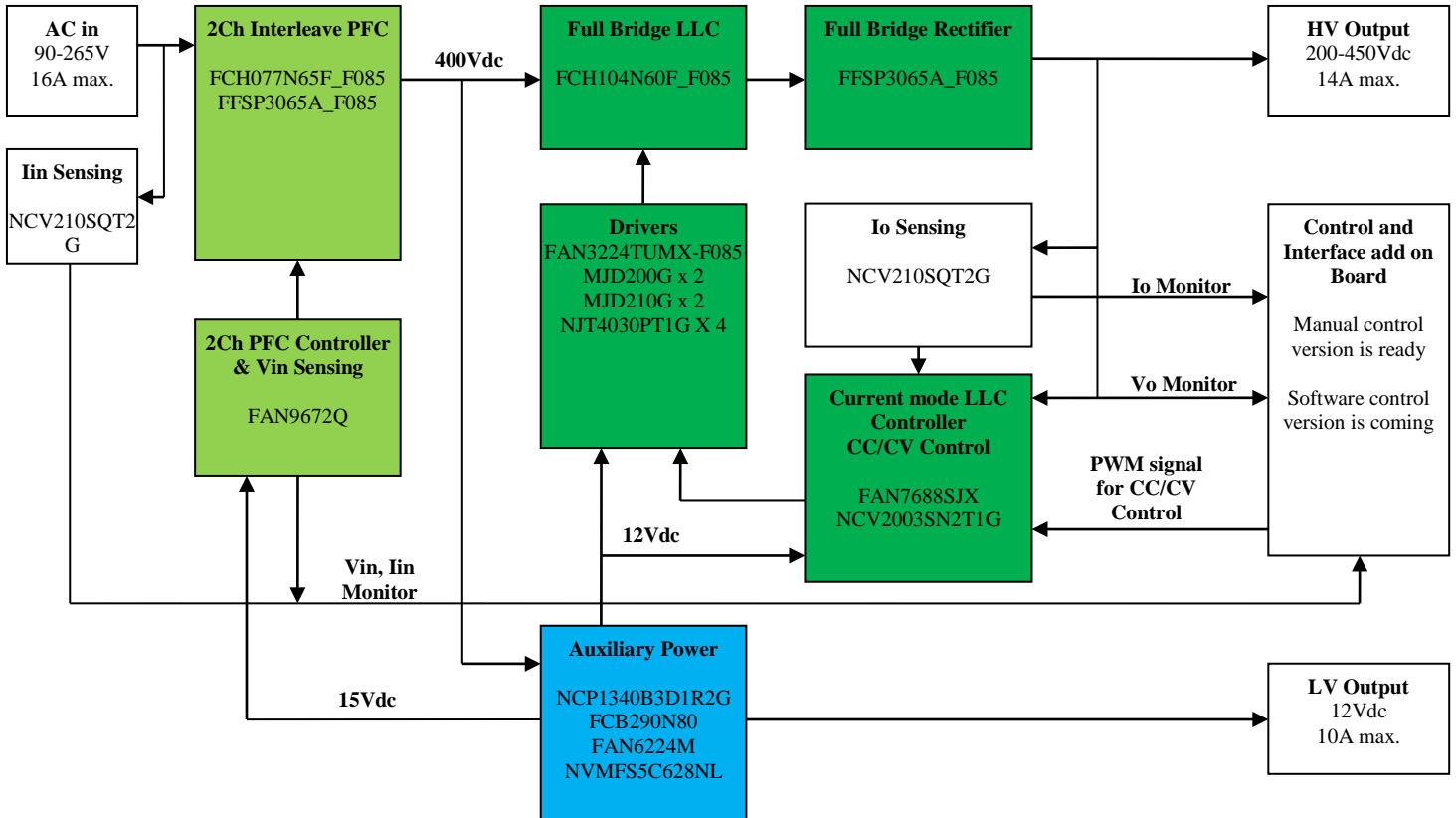

Figure 1. System diagram of the 3.3KW OBC

Following the AC input is the PFC stage. It's marked in light green. The detail schematic is shown on figure 2. The key elements of the PFC stage are the controller FAN9672 and the dual boost power devices. They are in the right hand of the figure 2. More details of the FAN9672 please refer the datasheet and the application notes of the device on the web site <https://www.onsemi.cn/PowerSolutions/product.do?id=FAN9672>. Among others, to avoid the CS+ signals are short circuit equivalent by C42 and C43, we placed the decouple inductors L21 and L31 on the Vcc of the Totem poles.

On left hand of figure 2, there are 3 blocks in red dash line. The upper block is the inrush current limit circuit. On this reference design, there are two options: NTC and Active mode. The NTC is a traditional method to limit the charge current of the bulk E-capacitor during power on moment. RT1 and RT2 are those NTCs. After the E-cap C7, C8 are fully charged, the relay RL1 is turned on to short circuit the NTCs to decrease the power loss. On the NTC mode, the D3 is unnecessary. This method is simple but the performance is limit. So we provided an active mode for choice. The most circuits of the active inrush current limit beside D3 are on a daughter board which connects to the SW_MODE_IRCLA. The detail schematic and the operating theory we will describe later.

© 2018, SCILLC.

Disclaimer: Semiconductor Components Industries, LLC (SCILL) dba ON Semiconductor is providing this design note "AS IS" and does not assume any liability arising from its use; nor does SCILLC convey any license to its or any third party's intellectual property rights. This document is provided only to assist customers in evaluation of the referenced circuit implementation and the recipient assumes all liability and risk associated with its use, including, but not limited to, compliance with all regulatory standards. SCILLC reserves the right to make changes without further notice to any products herein. SCILLC makes no warranty, representation or guarantee regarding the suitability of its products for any particular purpose, nor does SCILLC assume any liability arising out of the application or use of any product or circuit, and specifically disclaims any and all liability, including without limitation special, consequential or incidental damages.

DN05107/D

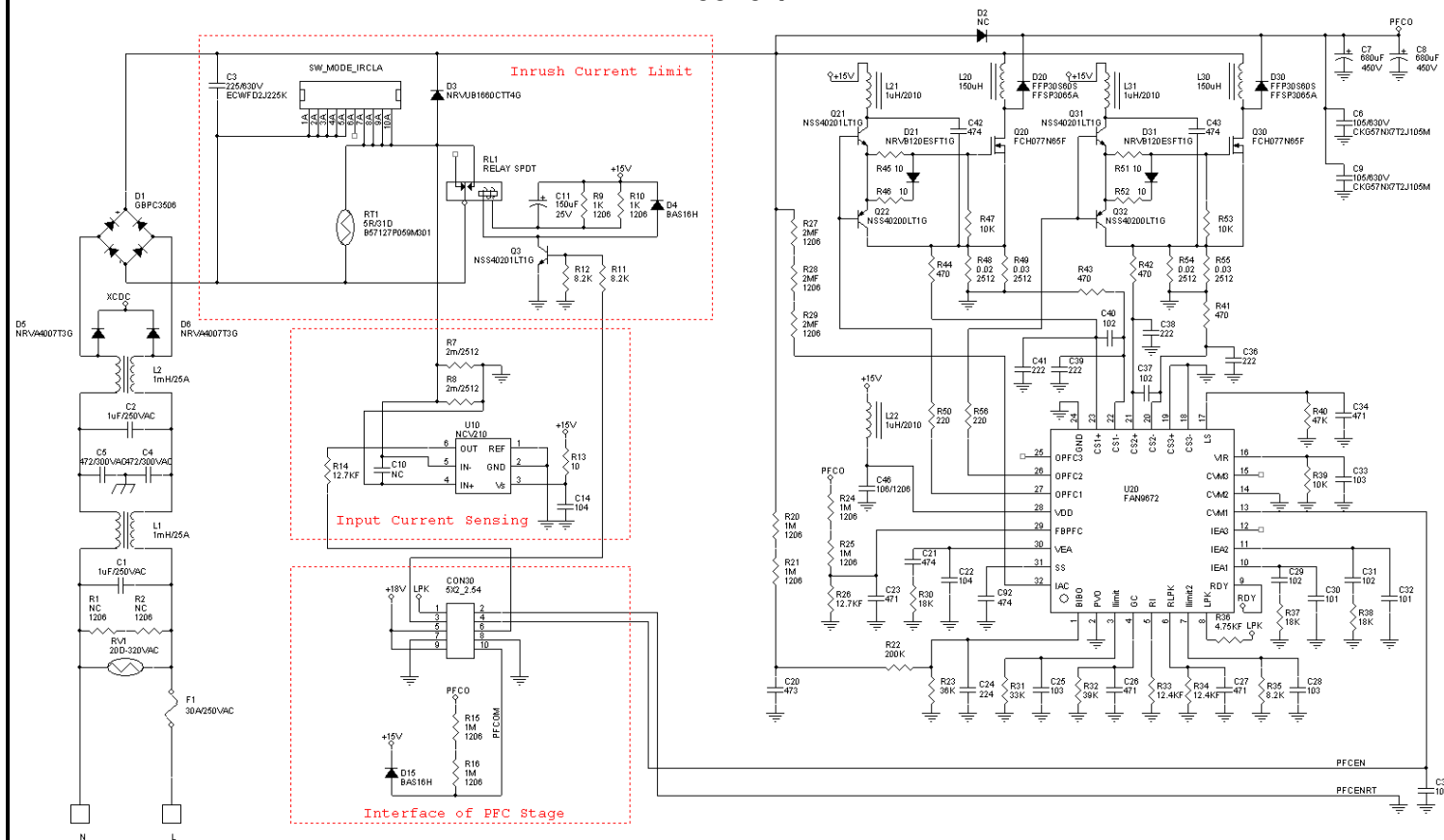

Figure 2. Schematic of the PFC

The middle block is the input current sensing circuit. The standard of the OBC required the input current must be under a safety level to prevent the power cord and the connector overheat in every condition. So the charger system must monitor the input current continually. If the input current over the limit by the reason of the input voltage get lower or any others, the system must decrease the output power. The U10 is the 200X fix-gain current sense amplifier. Co-operate with the R7 and R8, the voltage on pin6 of U10 will be $200 \times 0.001 \times I_{in}$. If $I_{in}=16A_{rms}$, at peak point of the sin wave, the output of U10 is 4.525V.

The lower block is the interface of the PFC stage. The 10pin connector CON30 connects the PFC stage to the interface board. The table 1 shows the signals on the CON30.

| Pin No. | Direction | Description |
|---------|-----------|--|
| 1 | Output | Input voltage sensing. |
| 2 | - | Return of PFC enable signal. Connect to GND of FAN9672 in differential path with Pin5. |
| 3 | Input | Relay Control signal. |
| 4 | Input | PFC enable signal. Control CM1 of FAN9672. |
| 5 | Output | +18V. |
| 6 | Output | Input current sensing signal. |
| 7 | - | GND |
| 8 | - | GND |
| 9 | Output | +18V. |
| 10 | Output | PFC output voltage sensing. |

Table 1. Signals of the CON30

Another key element of the OBC is the DCDC stage. It was marked in dark green in figure 1. The schematic of the DCDC stage is shown in figure 3. We adopt the full bridge LLC topology to get the high efficiency and suitable cost. It composed by U60 and Q60, Q61, Q70, Q71 etc. The FAN7688 (U60) is a current mode advanced LLC controller. More details of the FAN7688 please refer the datasheet and the application notes on the web site

DN05107/D

<https://www.onsemi.cn/PowerSolutions/product.do?id=FAN7688>. Because of the high output voltage (200-450Vdc), the Synchronous Rectifier cannot help too much on the rectifier conduction loss. So we omitted the SR function of the FAN7688. Find a suitable power transformer and resonate inductor on the 3KW power level is not easy. We used 2pcs EPC54 dual slot bobbin and core to make the transformer. It integrates the resonate inductor to save the room and conduction loss. On the primary side the two transformers are in series and on the secondary side, the two transformers are in parallel. Thus the voltage and current between the two transformers is balance automatically.

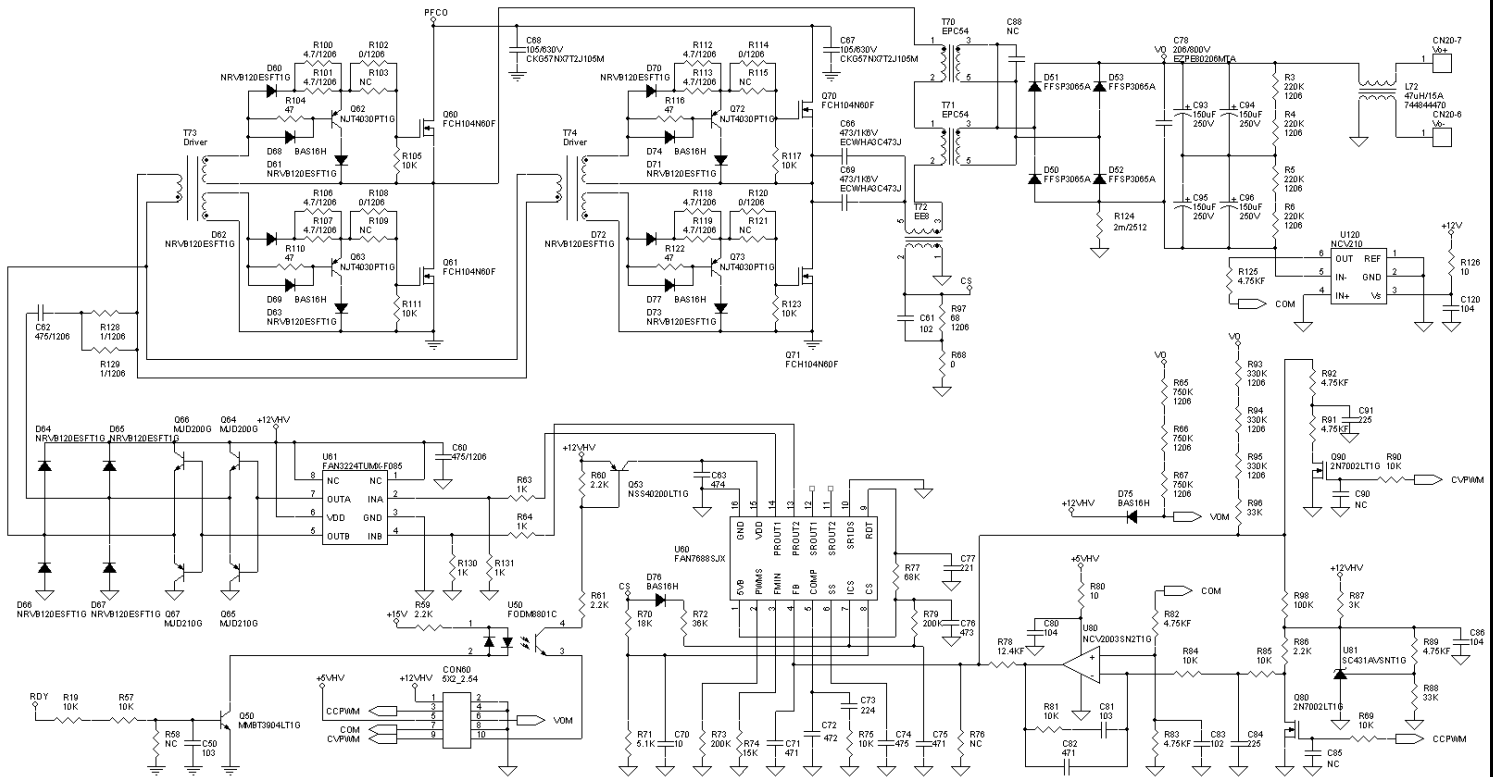

Figure 3. Schematic of the DCDC

Driving the full bridge MOSFETs with the half bridge LLC controller like FAN7688 is not difficult. Just drive the diagonal MOSFETs by the same signal is okay. To drive the low $R_{ds(on)}$ MOSFETs need strong driver ability. The PROUT signals of FAN7688 amplified by the U61 (FAN3224) and expend the current driving ability by the totem pole (Q64-Q67) then delivery to primary side trough pulse transformers T62 and T72. Emitter followers Q62, Q63, Q72 and Q73 are to speed up the turning off of the MOSFETs.

The FAN7688 integrated a voltage reference and an error amplifier inside. For the CV (Constant Voltage) control, we just follow the typical application of the FAN7688 is okay. What we need to do in the OBC application is just to add a CC (Constant Current) control loop. The U80 rail to rail amplifier and peripheral components acted as this role. During the CV mode, the U80 is in saturation. The voltage drops on the output of U80 can be ignored. On the close loop state, the output voltage determined by the voltage dividing resistors (R93, R94, R95, R96, R78, R91 and R92. We ignore the effect of R98 here for easy calculation) and the PWM duty of CV control signal CVPWM. If CVPWM duty=100%, the output voltage will be $2.4 \times \{R93 + R94 + R95 + R96 + [R78 // (R91 + R92)] / [R78 // (R91 + R92)]\}$. And if the CVPWM duty=0, the output voltage will be $2.4 \times (R93 + R94 + R95 + R96 + R78) / R78$. Fill the value of the resistors; the output voltage will change from 458.8V to 200.4V if the CVPWM duty decreases from 100% to 0. The purpose of R98 is to add a small bias voltage on the FB pin. Without it the current on the resonate tank may increase too fast during the start up moment and trigger the over current protection. The R98 is also makes the output voltage lower a little bit than we calculate above. Please make an alignment on whichever of R93, R94, R95, R96 or R78 if necessary.

The circuit around the U120 and R124 is to sense the output current. It's quit same with the block of U10 which we discussed above. CN60 is the interface of the DCDC stage. The table 2 shows the signals on the CON30.

The FAN7688 get VDD when both of the PFC RDY and the LLC enable signal are active.

DN05107/D

| Pin No. | Direction | Description |
|---------|-----------|--|
| 1 | Output | +12VHV. |
| 2 | - | GND |
| 3 | Input | CCPWM. PWM signal for content current setting. |
| 4 | - | GND |
| 5 | Input | +5VHV. |
| 6 | Output | VOM. Output voltage sensing. |
| 7 | Output | COM. Output current sensing. |
| 8 | - | GND |
| 9 | Input | CVPWM. PWM signal for content voltage setting. |
| 10 | Input | LLC enable signal. |

Table 2. Signals of the CON60

The third key element of the OBC is the Low Voltage and Auxiliary power. Figure 4 show the schematic.

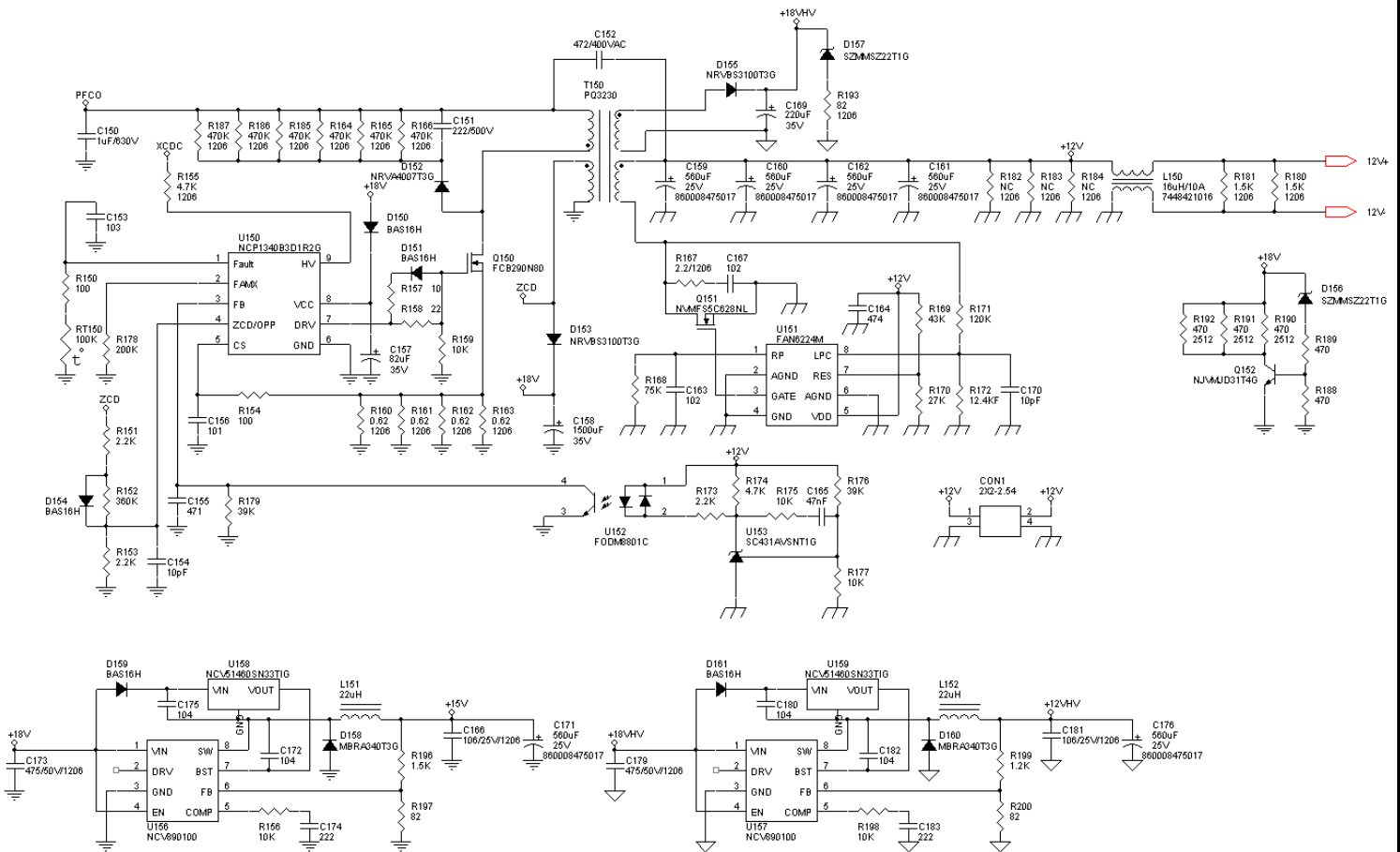

Figure 4. Schematic of the Low Voltage and Auxiliary power.

The main topology of the LV and auxiliary power is the QR fly-back. The LV output is 12V 10A. To increase the efficiency, we adopt the synchronous rectification. The detail of the PWM controller NCP1340 and the SR controller FAN6224 please refer the datasheet and application note on the web site: <https://www.onsemi.cn/PowerSolutions/product.do?id=NCP1340> and <https://www.onsemi.cn/PowerSolutions/product.do?id=FAN6224>.

This OBC has 3 separate GNDs. They are primary GND, LV output GND, and HV output GND. They are isolating each other. The can bus connect to LV GND. The DCDC controller connects to HV GND. Besides the LV output, the fly-back converter also provides the Vcc to PFC and DCDC controllers. So it has 3 isolating outputs. The feedback output of the PWM controller is the LV output because it's the heaviest load. But the load of LV output is uncertain. So the cross regulation is a problem. To avoid the voltage of +18V and +18VHV too high on the LV heavy load situation, we placed the active dummy load on the both output. They are Q152 and D157 and their peripheral components. Both of above dummy

DN05107/D

load can adjust the load current according to the output voltage automatically then save the power loss during the LV output light load moment.

Both of the PFC controller and LLC controller need the relative regulate Vcc for stable operating. The +18V and +18VHV output cannot meet regulation requirement due to the LV output's uncertainty. So the sub-regulator is necessary. For efficiency reason, we select the buck converters made by NCV890100PDR2G. This is a non-SR buck switching regulator with SO8-EP package. The switching frequency is up to 2MHz. The performance cost ratio is high and easy for application.

On the typical application circuit of NCV890100, the Bootstrap is powered by the internal 3.3V regulator. This method has a problem on this OBC design. In case of the load of LV is very light, the voltage of 18V and +18VHV will drop and close to 15V and 12V. The duty of the buck converter will be very large. Then the bootstrap voltage will drop below the DRV POR Stop Threshold and the device stop working. To save this problem we connect the bootstrap diodes (D159, D161) to Vin of the buck converters instead of the DRV pin. And insert a 3.3V LDO (U158, U159) from the bootstrap voltage to BST pin. This way extends the maxima duty range of the converter. And if the device stops working by Vin drop, once the Vin-Vo goes up to 3.3V, the device will re-work again. But in the typical application circuit, if the device stops working, It will keep stop until the Vo drop to 0V.

The connector CN1 deliveries the +12V voltage to the interface board.

In this design, we put the interface circuits on an add-on board for the flexibility. The features of the full function interface board will include the (1) Can communication with the BMS system to report the information like: Input voltage, Input current, Output voltage, Output current, Bus voltage, Output miss-connection, LV voltage, Temperature of the Bridge Rectifier, Temperature of the PFC MOFETs and Diodes, Temperature of the PFC Inductors, Temperature of the LLC transformers, Temperature of the LLC Diodes. (2) Can communication with the BMS to receive the following command: Power-up, Output voltage, Output current, Power off. (3) Output the CC, CV PWM signals and the power-on and relay-on signals to the main board. But, the full function interface board is not ready so far. We use a simple manual control board instead of the full function one. Figure 5 show the schematic of the manual control interface board.

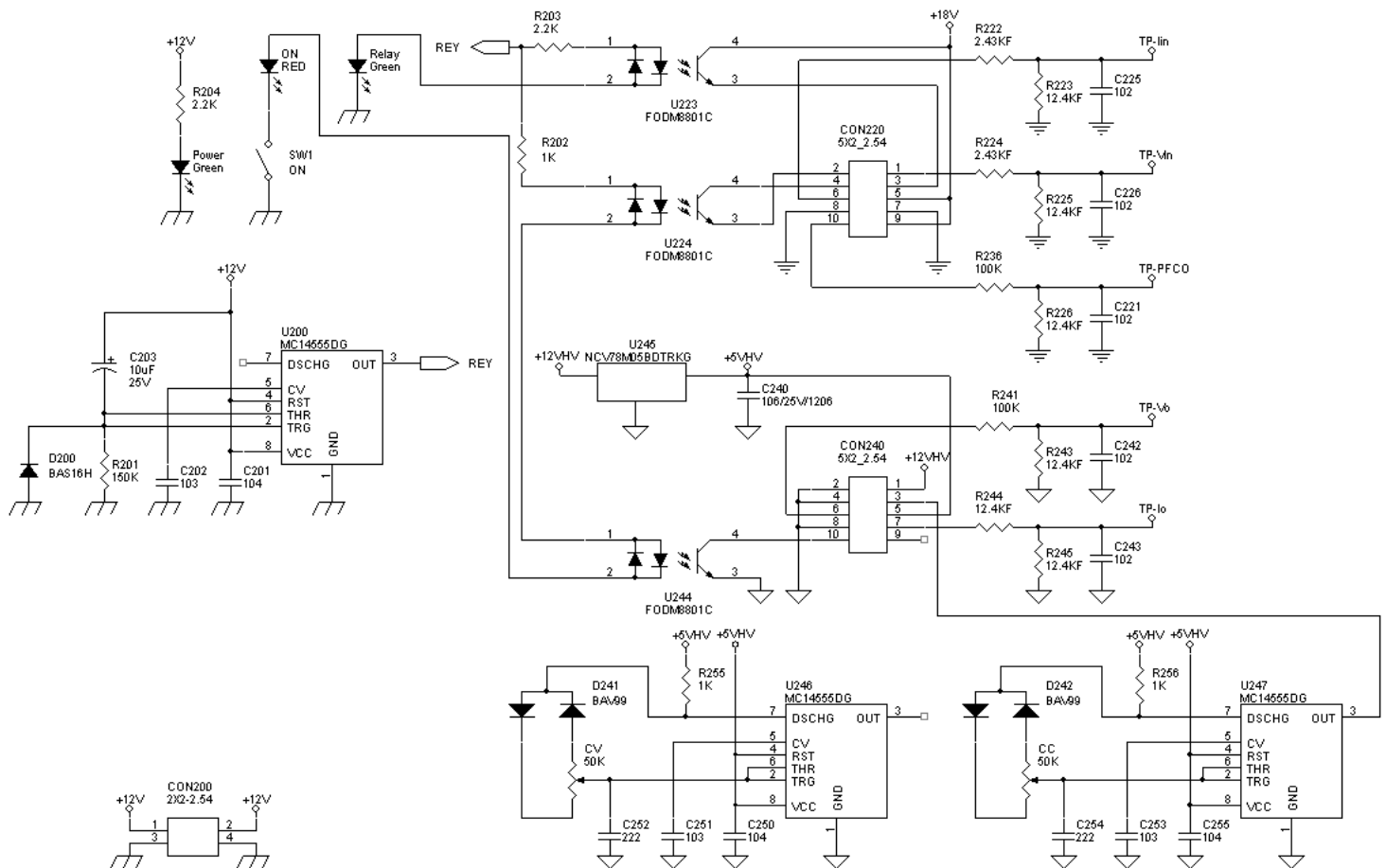

Figure 5. Schematic of the manual control interface board.

DN05107/D

The SW1 powers ON/OFF the PFC and LLC stage in the secondary side for safety. It is delivery to the primary and HV stage by U223 and U224. The Vcc of the U223 and U224 is powered by the REY signal, thus the power-up will be AND with the relay active. The REY signal is 3 second delayed by U200 from the 12V LV active moment to guarantee the Bus Caps is full charged. The CC and CV PWM signals are generated by the U246 and U247 and the peripherals components. The variable resistors CC and CV control the duty of the PWM signals. The sensing signals like Vin, lin, Vbus, Vo and Io was connected to the test points for customer testing by the voltage meter.

During the description of the PFC stage, we mentioned we provided two methods to limit the inrush current which charge the bus-caps on the power cord plug-in moment. The NTC is one of the most popular solutions. We will not discuss here. What we will high-light is the active inrush current limit circuit which is shown in figure 6.

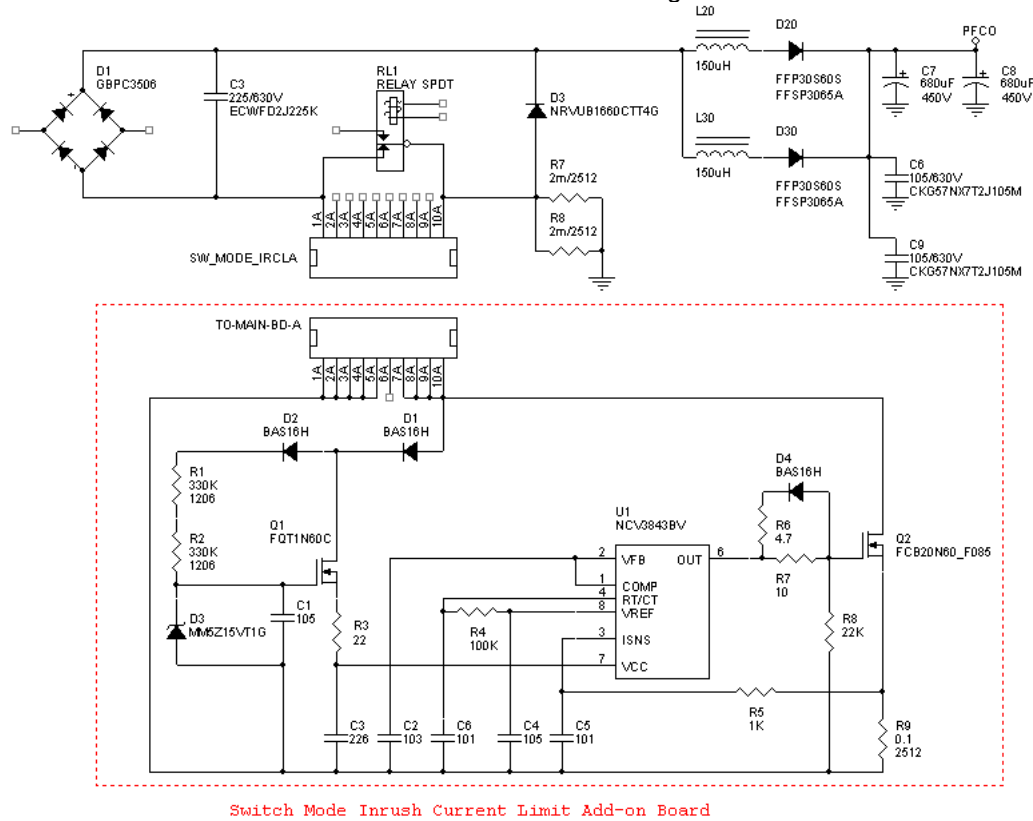

Figure 6. Schematic of switch mode inrush current limit circuit.

The circuits in the red dash-line box locate on the switch mode inrush current limit add-on board. The add-on board connects to the main board with two paths. The left path connect to the Source pin of the MOSFET Q2 through the current sense resistor R9. And the right path connects to the Drain pin of Q2 directly. The Q2 is controlled by the PWM controller U1. The U1 turns on in a fixed switching frequency and turns off triggered by the current sense signal with a fixed level. So the whole add-on board can be tread as a fixed frequency, fixed turn off current threshold switch. The circuits around Q1 provide the Vcc to U1. The switch Q2 and the freewheel diode D3; inductors L20 and L30 composed a buck converter. This buck converter charges the bus capacitors C7, C8 during the moments when the rectifier AC voltage is higher than the bus voltage. The charging speed depends on the peak current which can be programmed by the R9. If we set the peak current to a reasonable level, inrush current is limited. This inrush current limit methodology is different from the traditional methods witch use the NTC, PTC, fixed resistor or MOSFET or IGBT which working under the linear mode. It works on the switch mode. The power loss of the devices is limited. So the footprint of the circuits is small than the traditional methods. This feature is valuable for the OBC. By using the PFC inductors as the buck inductor, the cost of this solution is not higher than the traditional method so much.

MEGNATICS DESIGN DATA SHEET

PFC Inductors: L20, L30.

CUSTOMER TERMINAL ROHS LEAD(Pb)-FREE

| | | |
|---------------|-----|-----|
| Sn 96%, Ag 4% | Yes | Yes |
|---------------|-----|-----|

PART MUST INSERT FULLY TO SURFACES A IN RECOMMENDED GRID # 0356(6) [1.00]

DOT LOCATES TERM. #1

1.800 MAX. [44.00]

1.693 MAX. [43.00]

1.110 MIN. [2.80]

1.850 MAX. [47.00]

1.500 [38.10]

200 [5.08]

600 [15.24]

063(6) [1.60]

LOT CODE & DATE CODE

RECOMMENDED P.C. PATTERN, COMPONENT SIDE

TERM. NO.'s FOR REF. ONLY

ELECTRICAL SPECIFICATIONS @ 25° C unless otherwise noted:

| PARAMETER | TEST CONDITIONS | VALUE |
|--------------------|--|-----------------|
| D.C. RESISTANCE | 4-7 Ite(4+5+6,7+8+9), @20°C | 0.042 ohms max. |
| INDUCTANCE | 4-7 Ite(4+5+6,7+8+9), 50kHz, 100mV, Ls | 150.0µH ±10% |
| SATURATION CURRENT | 4-7 Ite(4+5+6,7+8+9), 20% rolloff from initial | 20A |

GENERAL SPECIFICATIONS:
OPERATING TEMPERATURE RANGE: -40°C to +125°C including temp rise.

Customer to tie terminals 4&5&6 and 7&8&9 internally on PC Board.

Application of transformer allows for leadwires between terminals 4&5&6 and 7&8&9 to solder bridge.

Wire insulation & RoHS status not affected by wire color. Wire insulation color may vary depending on availability. Tolerances unless otherwise specified:
Angles: ±1°
Decimals: ±.005 [.13]
Fractions: ±1/64 Footprint: ±.001 [.03]
This drawing is dual dimensioned. Dimensions in brackets are in millimeters.

| | |
|------|-----|
| DFM | |
| DATE | |
| ENG | HWE |
| REV. | 04 |
| DATE | |

DRAWING TITLE

INDUCTOR

| | |
|----------------------------|------------------|
| PART NO. | 750343627 |
| SPECIFICATION SHEET 1 OF 1 | |

Auxiliary Transformer: T150.

| | | |
|-------------------|------|---------------|
| CUSTOMER TERMINAL | RoHS | LEAD(Pb)-FREE |
| Sn 96%, Ag 4% | Yes | Yes |



ELECTRICAL SPECIFICATIONS @ 25° C unless otherwise noted:

| PARAMETER | TEST CONDITIONS | VALUE |
|--------------------|---|-----------------|
| D.C. RESISTANCE | 9-7 @20°C | 0.088 ohms max. |
| D.C. RESISTANCE | 12-11 @20°C | 0.016 ohms max. |
| D.C. RESISTANCE | 6-5 @20°C | 0.019 ohms max. |
| D.C. RESISTANCE | 3-1 tie(3+4,1+2), @20°C | 0.005 ohms max. |
| INDUCTANCE | 9-7 10kHz, 1V, Ls | 280.00µH ±10% |
| LEAKAGE INDUCTANCE | 9-7 tie(11mu6+11+12), 100kHz, 100mV, Ls | 6µH max. |
| DIELECTRIC | 1-12 tie(9+11,4+5), 3750VAC, 1 second | |
| TURNS RATIO | 9-1, ±1% (9-7):(6-5) | 9:1, ±1% |
| TURNS RATIO | 9-1, ±1% (9-7):(3-1), tie(3+4,1+2) | 9:1, ±1% |
| TURNS RATIO | | 13.5:1, ±1% |

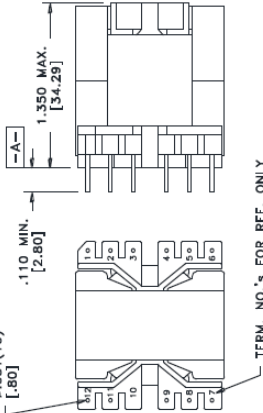
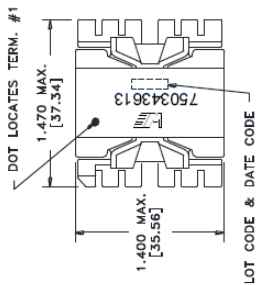

TERM. NO.'s FOR REF. ONLY

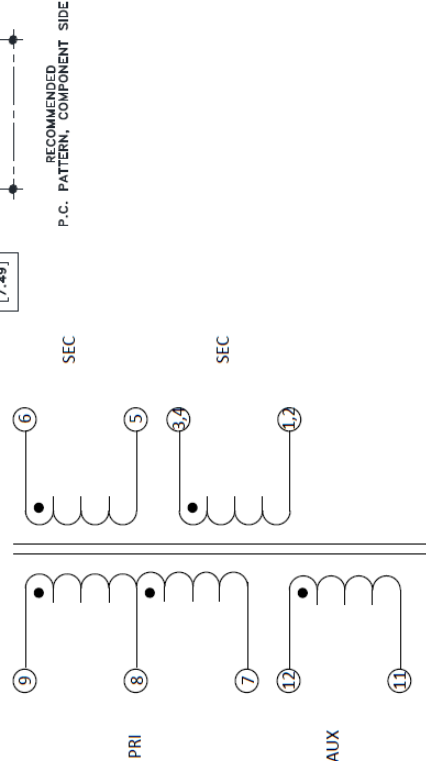
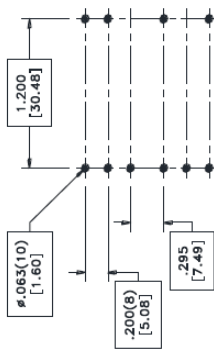

GENERAL SPECIFICATIONS:
OPERATING TEMPERATURE RANGE: -40°C to +125°C including temp rise.

Wire insulation & RoHS status not affected by wire color. Wire insulation color may vary depending on availability.

| | | | | |
|------|-----------|---|-------------------------------------|------------------------------|
| DFM | | Packaging Specifications Method: Tray PKG-0825 CONVENTION PLACEMENT www.wue-online.com/miscom | DRAWING TITLE TRANSFORMER | PART NO. 750343613 |
| DATE | | | | |
| ENG | HWE | | | |
| REV. | 00 | | | |
| DATE | 6/14/2017 | | | |

Tolerances unless otherwise specified:
 Angles: ±1°
 Decimals: ±.005 [.13]
 Fractions: ±1/64 Footprint: ±.001 [.03]
 This drawing is dual dimensioned. Dimensions in brackets are in millimeters.

Pulse Transformer: T73, T74..

more than you expect



ELECTRICAL SPECIFICATIONS @ 25° C unless otherwise noted:

| PARAMETER | TEST CONDITIONS | VALUE |
|--------------------|--|-----------------|
| D.C. RESISTANCE | tie(9+10,11+12), @20°C | 0.045 ohms max. |
| D.C. RESISTANCE | 1-2 @20°C | 0.06 ohms max. |
| D.C. RESISTANCE | 5-6 @20°C | 0.075 ohms max. |
| INDUCTANCE | tie(9+10,11+12), 10kHz, 100mV, Ls | 170.00µH min |
| LEAKAGE INDUCTANCE | tie(9+10,11+12,1+2+5+6), 100kHz, 100mV, Ls | 0.4µH max. |
| DIELECTRIC | 1-9 tie(1+5,9+10), 3750VAC, 1 second | - |
| TURNS RATIO | (1-2):(9,10-11,12) | 1:15:1, ±1% |
| TURNS RATIO | (1-2):(5-6) | 1:1, ±1% |

GENERAL SPECIFICATIONS:

OPERATING TEMPERATURE RANGE: -40°C to +125°C including temp rise.

| | | |
|-------------------|------|---------------|
| CUSTOMER TERMINAL | RoHS | LEAD(Pb)-FREE |
| Sn 96%, Ag 4% | Yes | Yes |

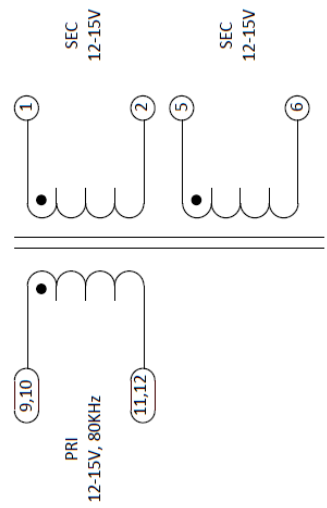
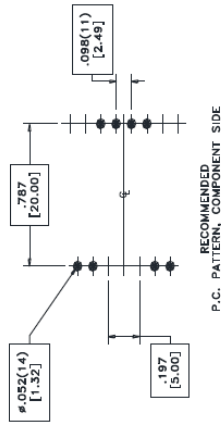
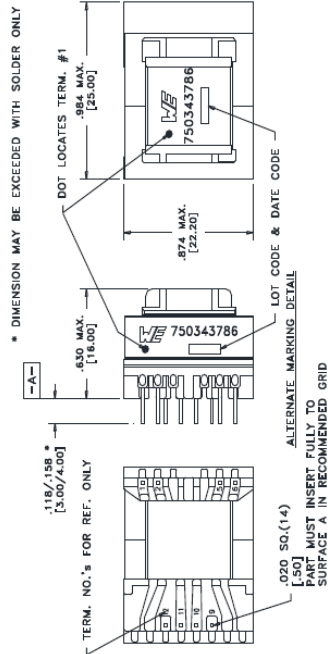

Application of the transformer allows for the leadwires between terminals 9&110, 11&12 to solder bridge.
Customer to tie terminals 9+10 and 11+12 on PC board.

Wire insulation & RoHS status not affected by wire color. Wire insulation color may vary depending on availability.

Tolerances unless otherwise specified:
Angles: ±1°
Decimals: ±.005 [.13]
Fractions: ±1/64
Footprint: ±.001 [.03]
This drawing is dual dimensioned. Dimensions in brackets are in millimeters.

| | | |
|------|--------------------------|----------------------|
| DFM | Packaging Specifications | CONVERSION PLACEMENT |
| DATE | Method: Tray | |
| ENG | PKG-0736 | |
| REV. | 00 | |
| DATE | 11/10/2017 | |

| | |
|--------------------|------------------|
| DRAWING TITLE | PART NO. |
| TRANSFORMER | 750343786 |

SPECIFICATION SHEET 1 OF 1

Current Transformer: T72.

more than you expect



ELECTRICAL SPECIFICATIONS @ 25° C unless otherwise noted:

| PARAMETER | TEST CONDITIONS | VALUE |
|-----------------|--------------------------|-------------------|
| D.C. RESISTANCE | 3-4 @20°C | 8.310 ohms max. |
| D.C. RESISTANCE | S-F @20°C | 0.010 ohms max. |
| INDUCTANCE | 3-4 50kHz, 100mV, Ls | 16.0mH min |
| DIELECTRIC | 3-S 3750VAC, 1 second | 3000VAC, 1 minute |
| DIELECTRIC | S-core 3750VAC, 1 second | 3000VAC, 1 minute |
| TURNS RATIO | (3-4)/(S-F) | 170:1, ±2% |

GENERAL SPECIFICATIONS:

OPERATING TEMPERATURE RANGE: -40°C to +125°C including temp rise.
 Designed to comply with the following requirements as defined by IEC60950-1, EN60950-1, UL60950-1/CSA60950-1 and AS/NZS60950-1:
 - Reinforced insulation for a primary circuit at a working voltage of 255Vrms, 400Vpeak, Overvoltage Category II.
 Current Rating: 4A(Ph S-F)

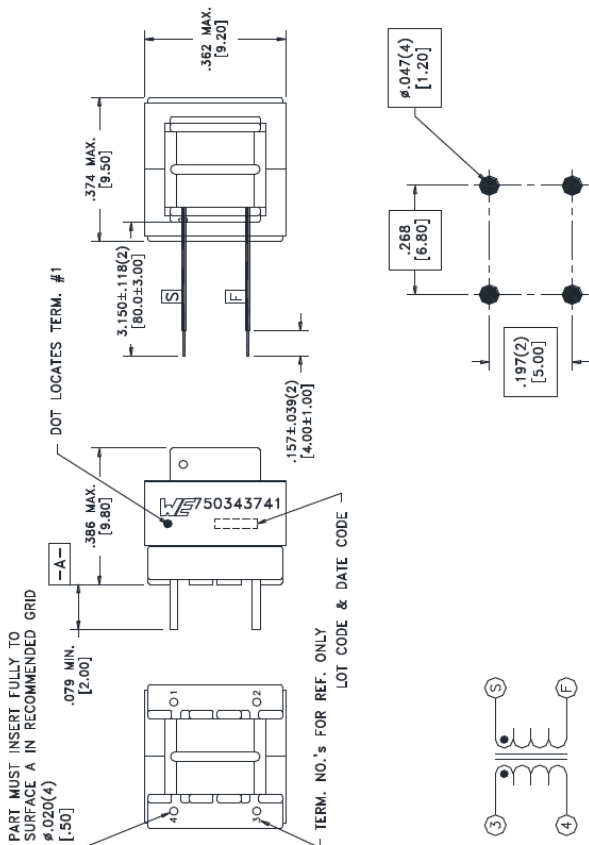

RECOMMENDED P.C. PATTERN, COMPONENT SIDE

| | | |
|-------------------|------|---------------|
| CUSTOMER TERMINAL | RoHS | LEAD(Pb)-FREE |
| Sn 96%, Ag 4% | Yes | Yes |

PART MUST INSERT FULLY TO SURFACE A IN RECOMMENDED GRID
 #.020(4)
 [.50]

DOT LOCATES TERM. #1

TERM. NO.'s FOR REF. ONLY
 LOT CODE & DATE CODE

Wire insulation & RoHS status not affected by wire color. Wire insulation color may vary depending on availability.

Tolerances unless otherwise specified:

Angles: ±1° Decimals: ±.005 [.13]
 Fractions: ±1/64 Footprint: ±.001 [.03]

This drawing is dual dimensioned. Dimensions in brackets are in millimeters.

| | | |
|------|--------------------------|--------------------------------|
| DFM | Packaging Specifications | CONVENTION PLACEMENT |
| DATE | Method: Tray | |
| ENG | NWA PKG-0542 | www.wk-electronic.com/tr/iecdm |
| REV. | 00 | |
| DATE | 9/15/2017 | |

DRAWING TITLE

TRANSFORMER

PART NO.

750343741

SPECIFICATION SHEET 1 OF 1

DN05107/D

LLC Transformers: T70, T71.

电气原理图

绕线结构图

● WINDING START KAPTON TAPE

电气参数

| NO. | 名称 | 测量端 | 测量值 | 测试条件 | 测试仪器 |
|-----|------|-------|--------------|------------------|--------|
| 1 | 电感量 | L(N1) | 60uH±10% | 10KHz 1V 25°C | HP4980 |
| 2 | 漏感 | L(N1) | 9.5uH±20%短N2 | | |
| 3 | 抗电强度 | 初级对次级 | 3000V AC | 1mA, 50Hz 60Sec. | CJ2671 |
| | | 线圈对磁芯 | 1500V AC | | |

海宁联丰东进电子有限公司
HAINING LIANFENG DONGJIN ELECTRONICS CO.,LTD

地址:浙江省海宁市盐官镇园区五路1号 ADD:NO.1, NO.5 Rd, YanGuan Town Area, HaiNing, ZheJiang, China
电话:0573-87633718/87633818 TEL: +86-573-87633718/87633818
传真:0573-87681200 FAX: +86-573-87681200
E-mail:lfshen@lfgmag.com http://www.lfdjg.com
shenlifeng@lfdjg.com

© 2014, SCILLC.

Disclaimer: Semiconductor Components Industries, LLC (SCILL) dba ON Semiconductor is providing this design note "AS IS" and does not assume any liability arising from its use; nor does SCILLC convey any license to its or any third party's intellectual property rights. This document is provided only to assist customers in evaluation of the referenced circuit implementation and the recipient assumes all liability and risk associated with its use, including, but not limited to, compliance with all regulatory standards. SCILLC reserves the right to make changes without further notice to any products herein. SCILLC makes no warranty, representation or guarantee regarding the suitability of its products for any particular purpose, nor does SCILLC assume any liability arising out of the application or use of any product or circuit, and specifically disclaims any and all liability, including without limitation special, consequential or incidental damages.

DN05107/D

Test Result

Power Factor

| PF | Vin=90Vac | Vin=110Vac | Vin=220Vac | Vin=264Vac |
|-----------|-----------|------------|------------|------------|
| Load=25% | 0.991 | 0.982 | 0.976 | 0.867 |
| Load=50% | 0.996 | 0.996 | 0.987 | 0.912 |
| Load=75% | - | - | 0.992 | 0.976 |
| Load=100% | - | - | 0.996 | 0.995 |

Efficiency of PFC stage

| Vin (Vac) | Pin (W) | Vo (V) | Io (A) | Po (W) | Efficiency |
|-----------|---------|--------|--------|---------|------------|
| 90 | 1256.6 | 392.27 | 3.020 | 1184.66 | 94.27% |
| 110 | 1609.2 | 392.27 | 3.905 | 1531.81 | 95.20% |
| 220 | 3314.3 | 392.30 | 8.280 | 3248.24 | 98.00% |
| 264 | 3296.0 | 392.46 | 8.285 | 3251.53 | 98.60% |

Waveforms of PFC stage. Yellow: Inductance current of CH1; Green: Vds of CH1; Cyan: Vds of CH2; Pink: Vbus.

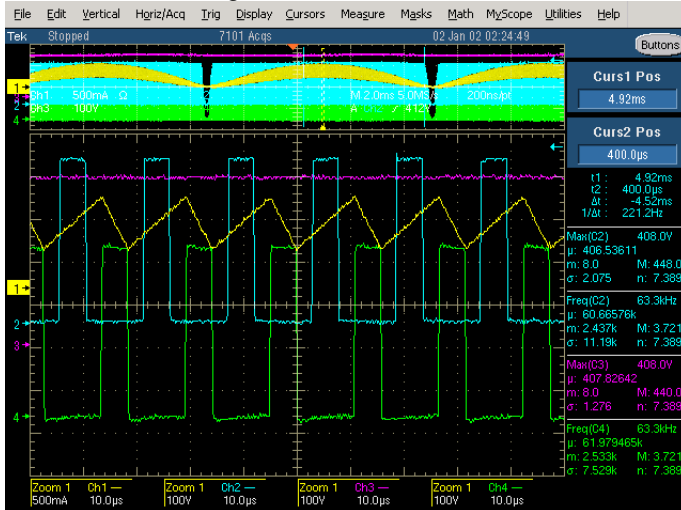

Vin=90Vac, Pin=1250W

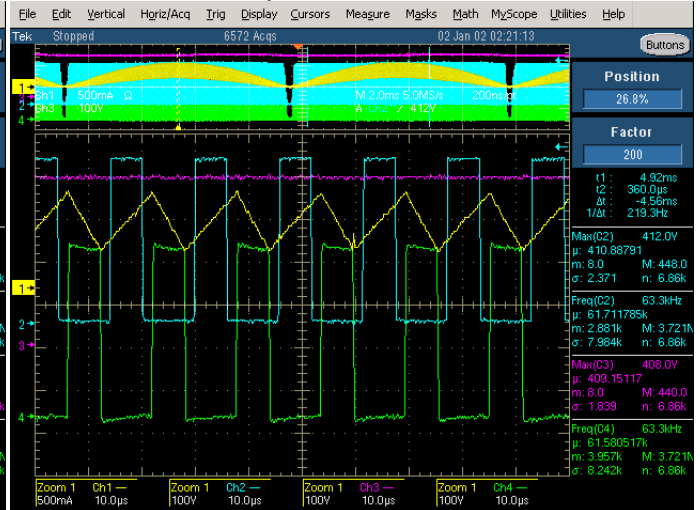

Vin=110Vac, Pin=1610W

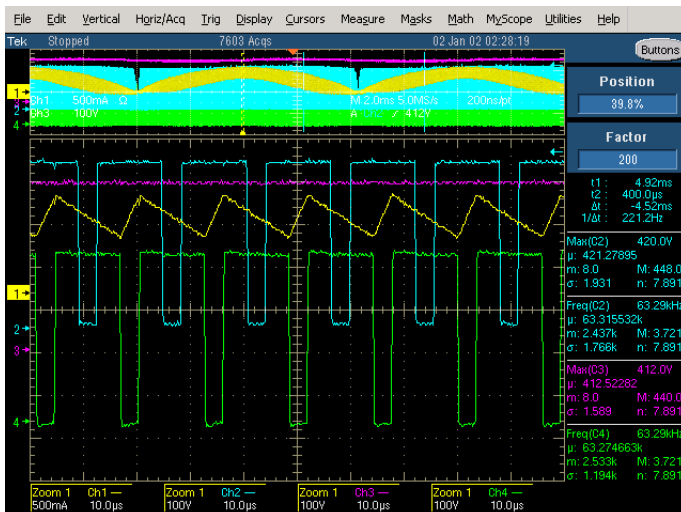

Vin=220Vac, Pin=3315W

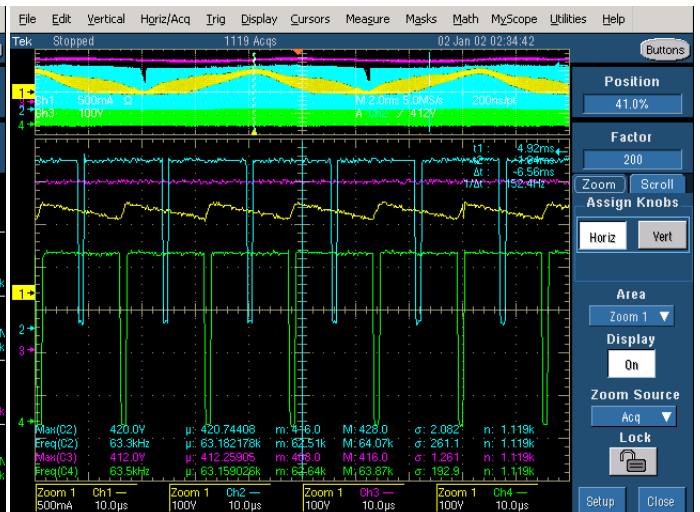

Vin=264Vac, Pin=3296W

DN05107/D

Efficiency of total set

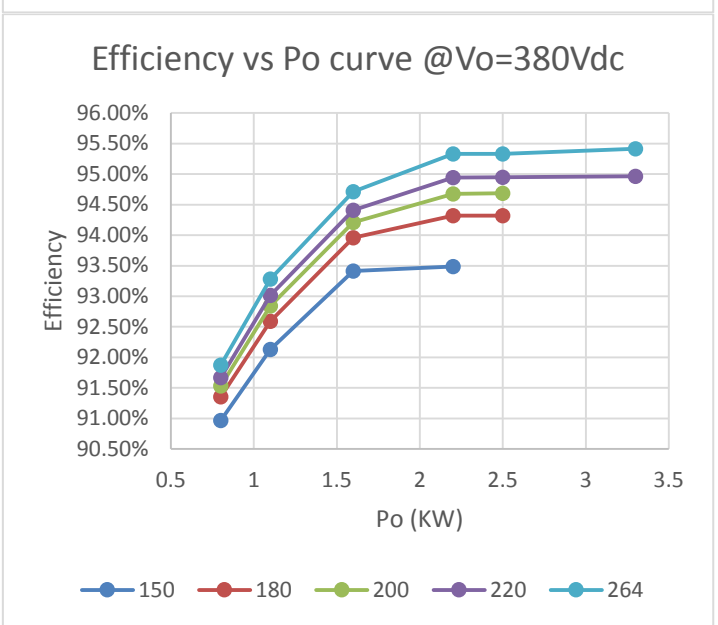
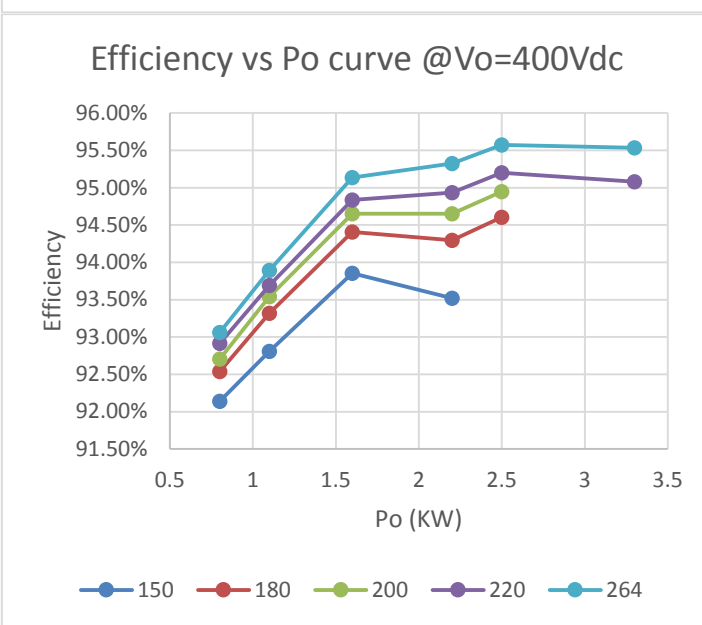
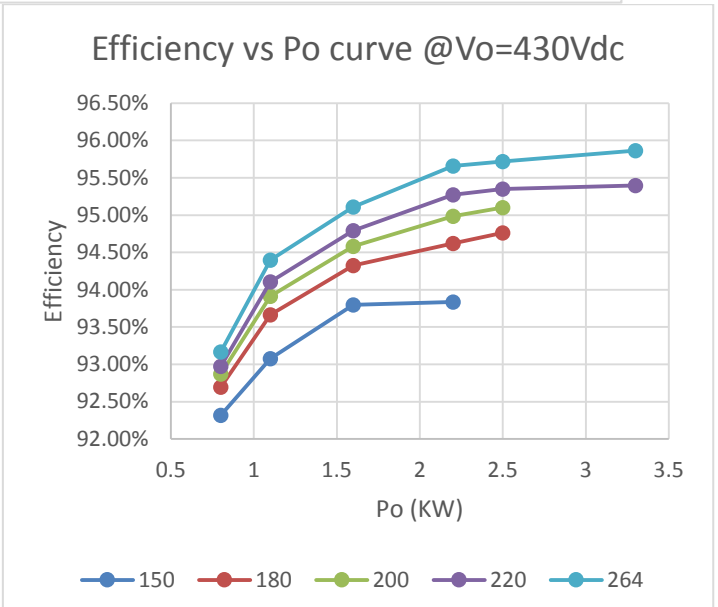
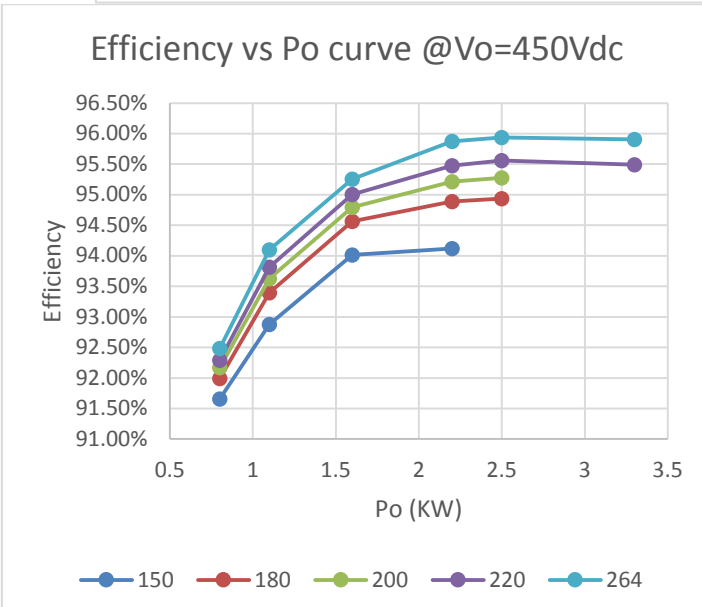
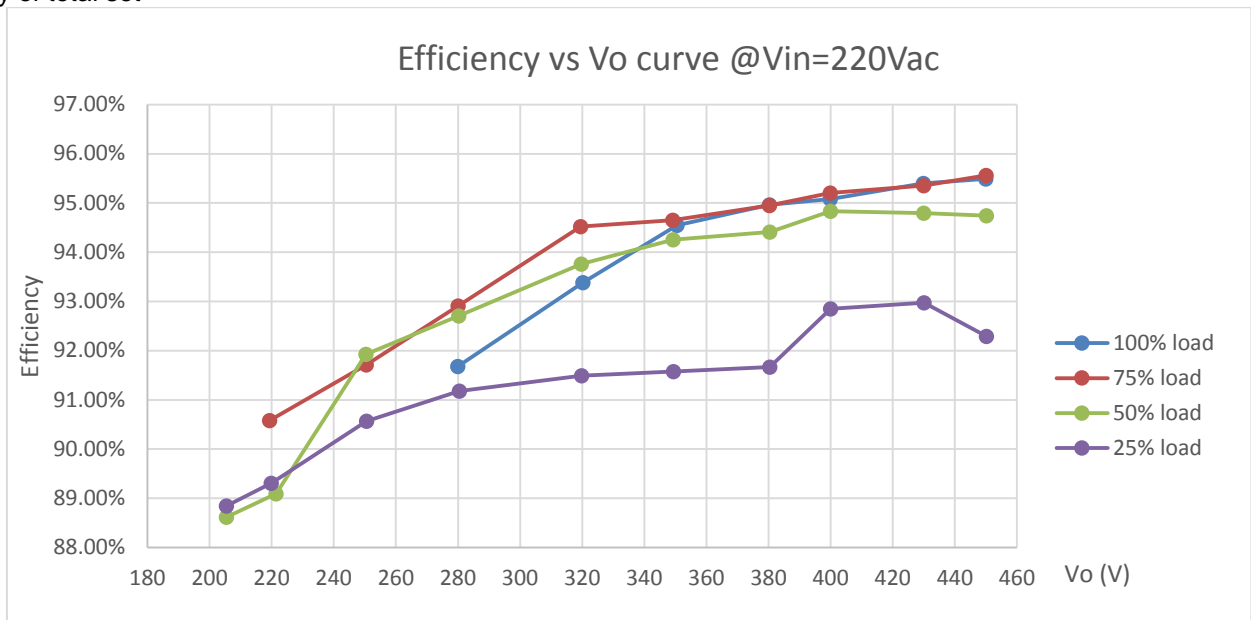

DN05107/D

Efficiency vs Po curve @Vo=350Vdc

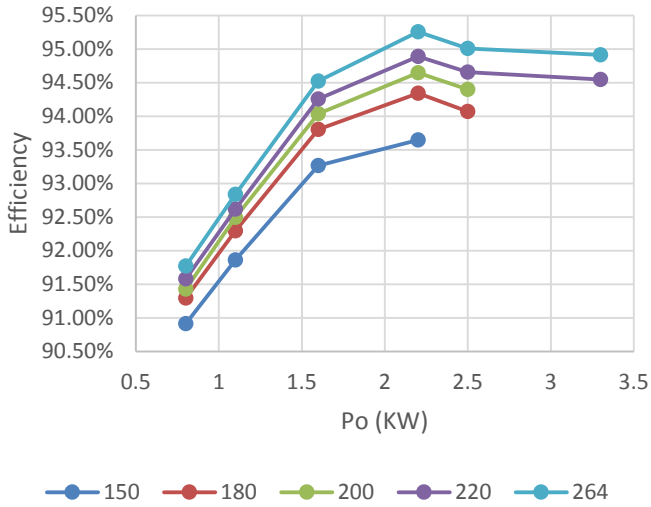

Efficiency vs Po curve @Vo=320Vdc

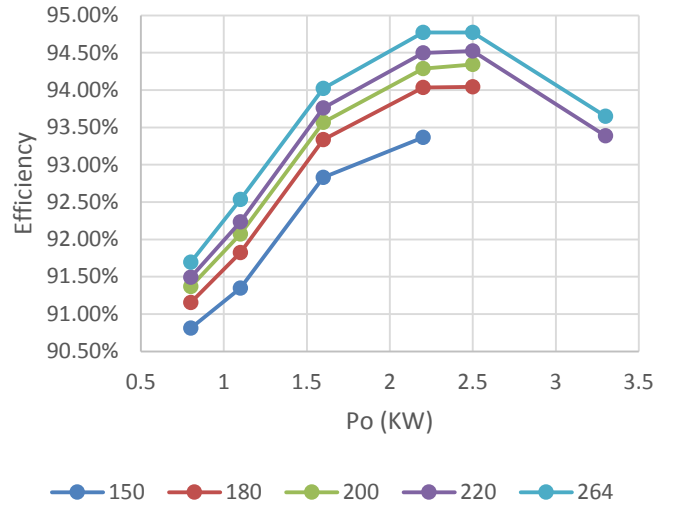

Efficiency vs Po curve @Vo=280Vdc

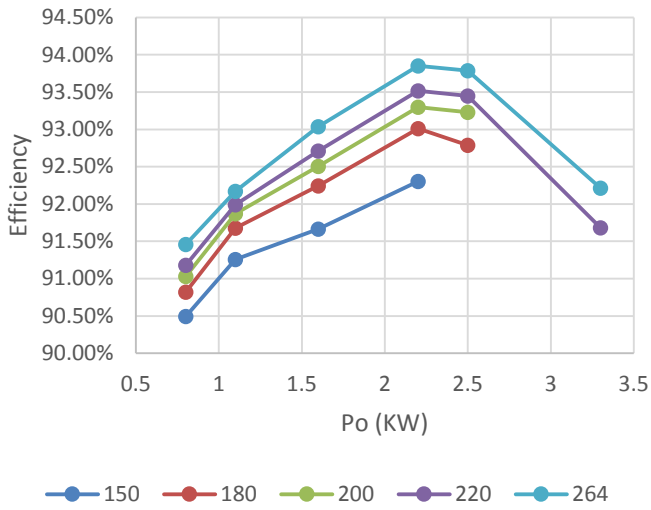

Efficiency vs Po curve @Vo=250Vdc

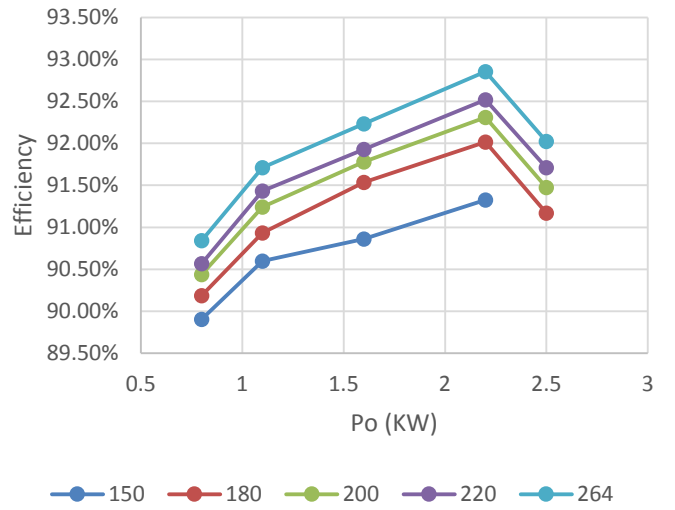

Efficiency vs Po curve @Vo=220Vdc

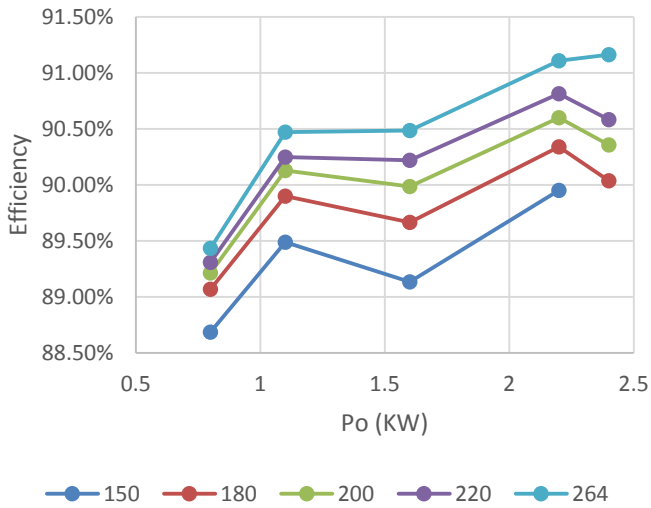

Efficiency vs Po curve @Vo=200Vdc

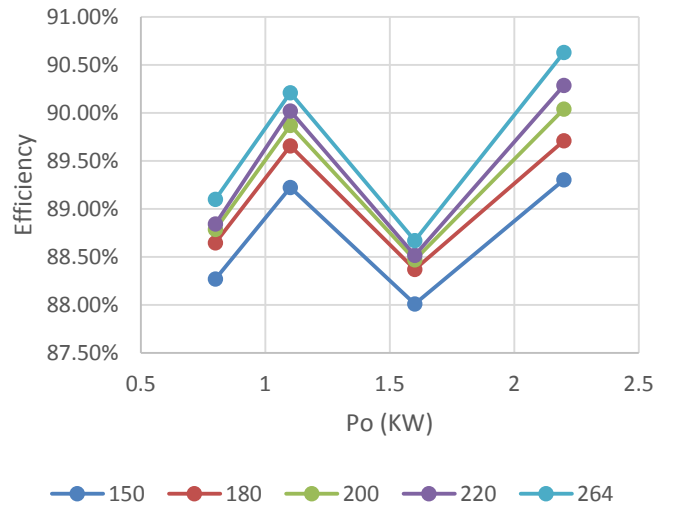

DN05107/D

Waveforms of LLC stage. : Green: Current of the resonate tank; Yellow: Drain of Q61; Pink: Drain of Q71.

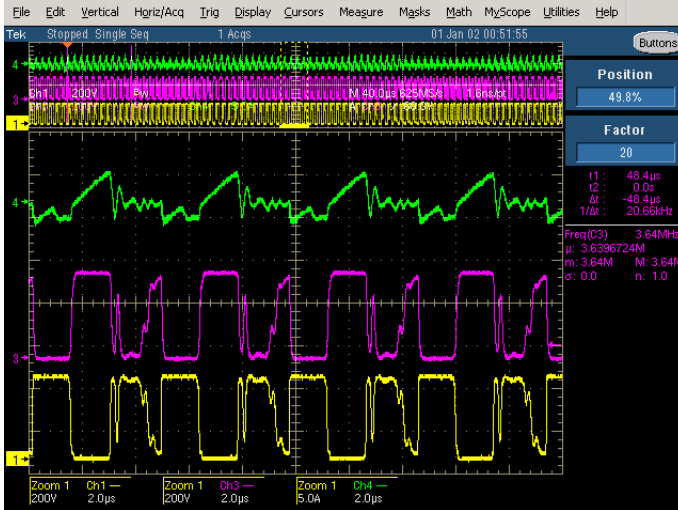

Vo=450Vdc, Load=10%

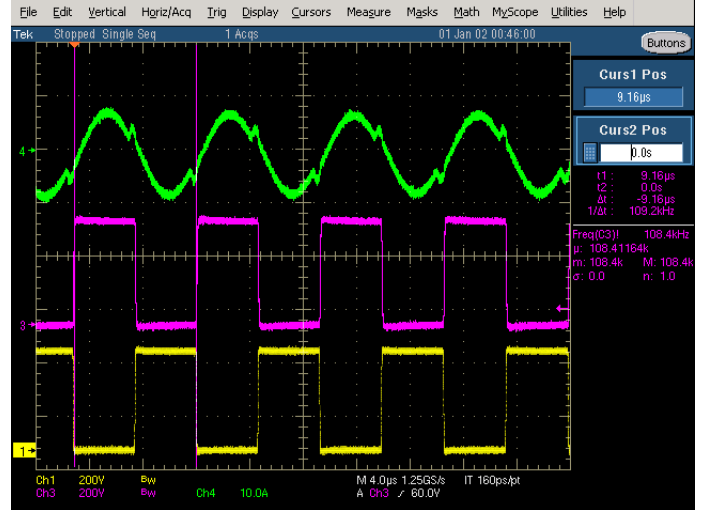

Vo=450Vdc, Load=50%

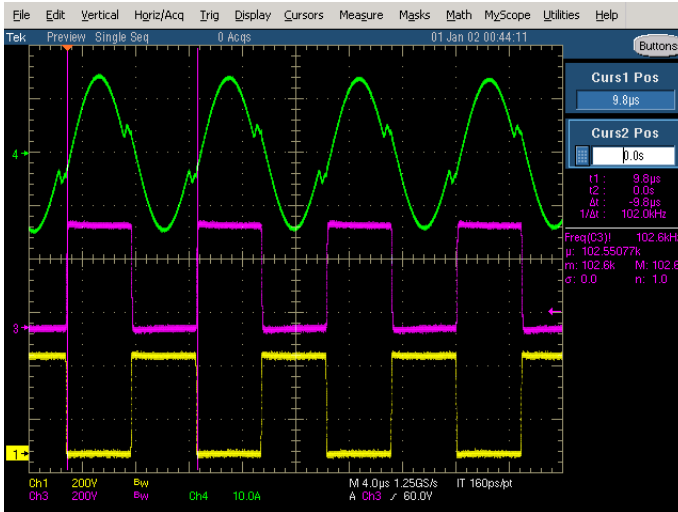

Vo=450Vac, Load=100%

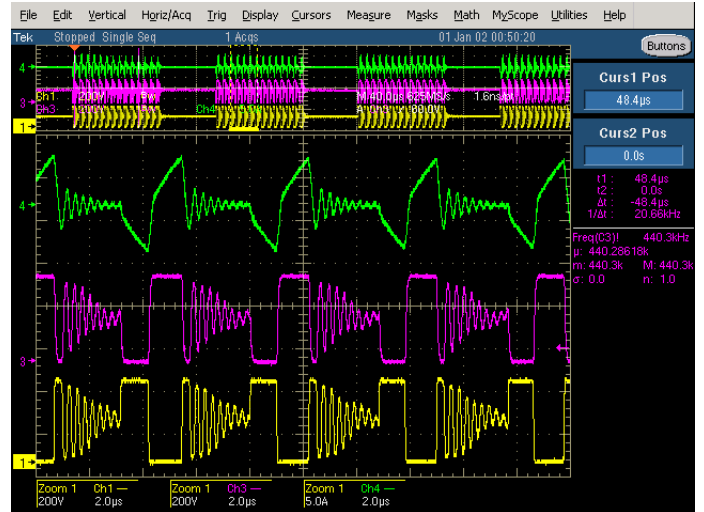

Vin=350Vac, Load=10%

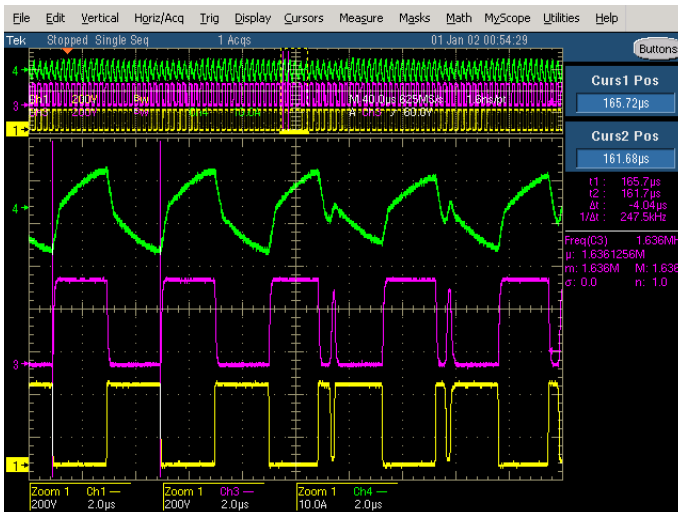

Vo=350Vac, Load=50%

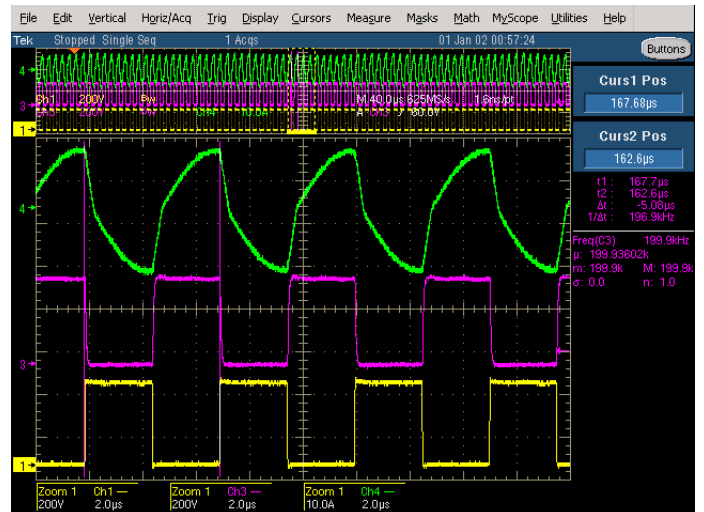

Vin=350Vac, Load=100%

DN05107/D

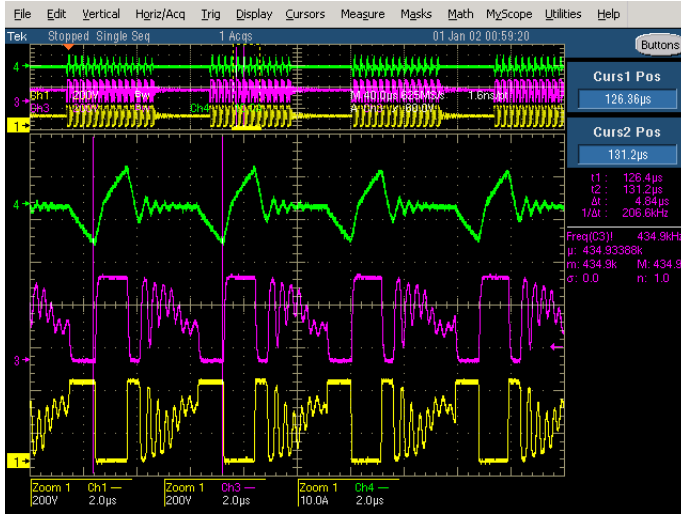

Vo=250Vac, Load=10%

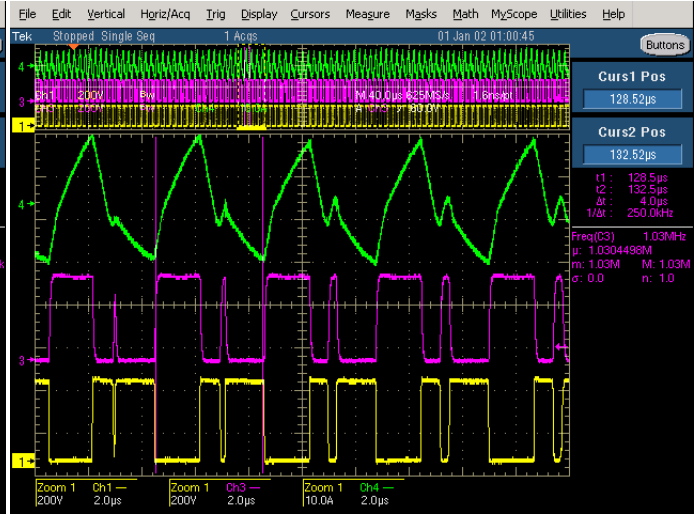

Vin=250Vac, Load=50%

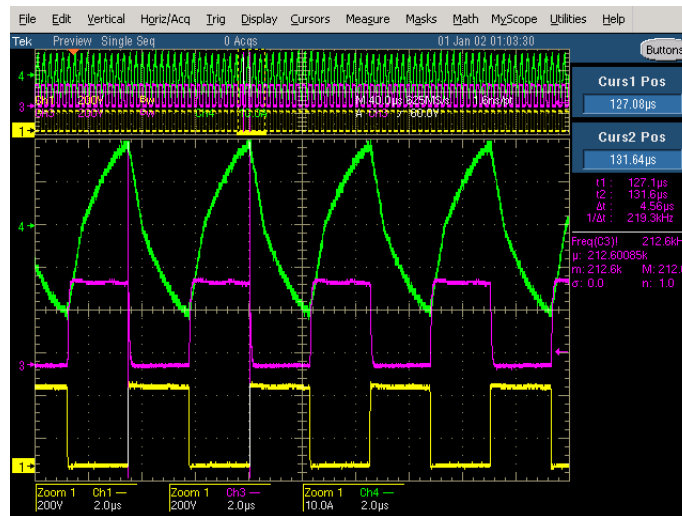

Vo=250Vac, Load=100%

Waveforms of start-up. Pink: AC input voltage; Green: AC input current; Cyan: Bus voltage; Yellow: Output voltage.

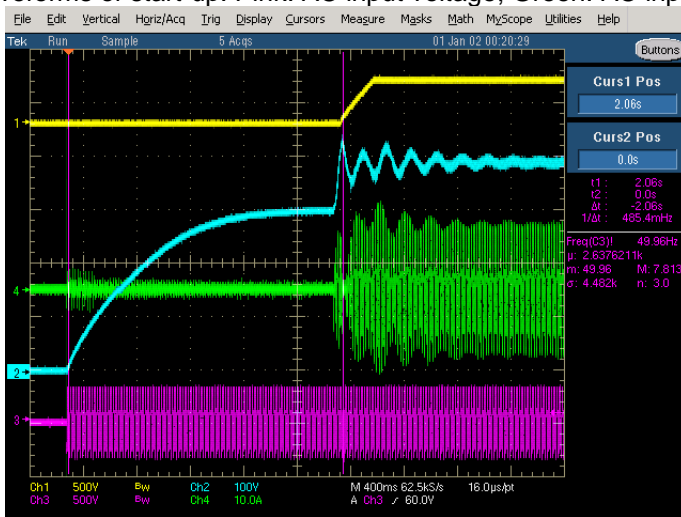

Switch mode inrush current limit board

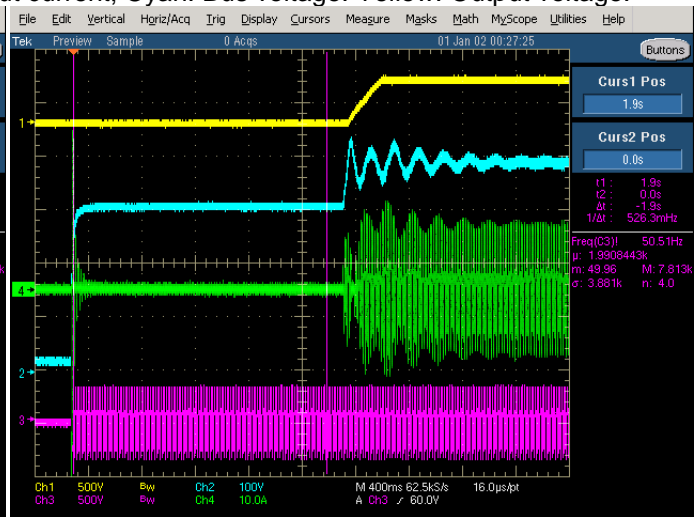

NTC

DN05107/D

PCB Layout

Top side of main board. 254x180.4x2mm. 2oz.

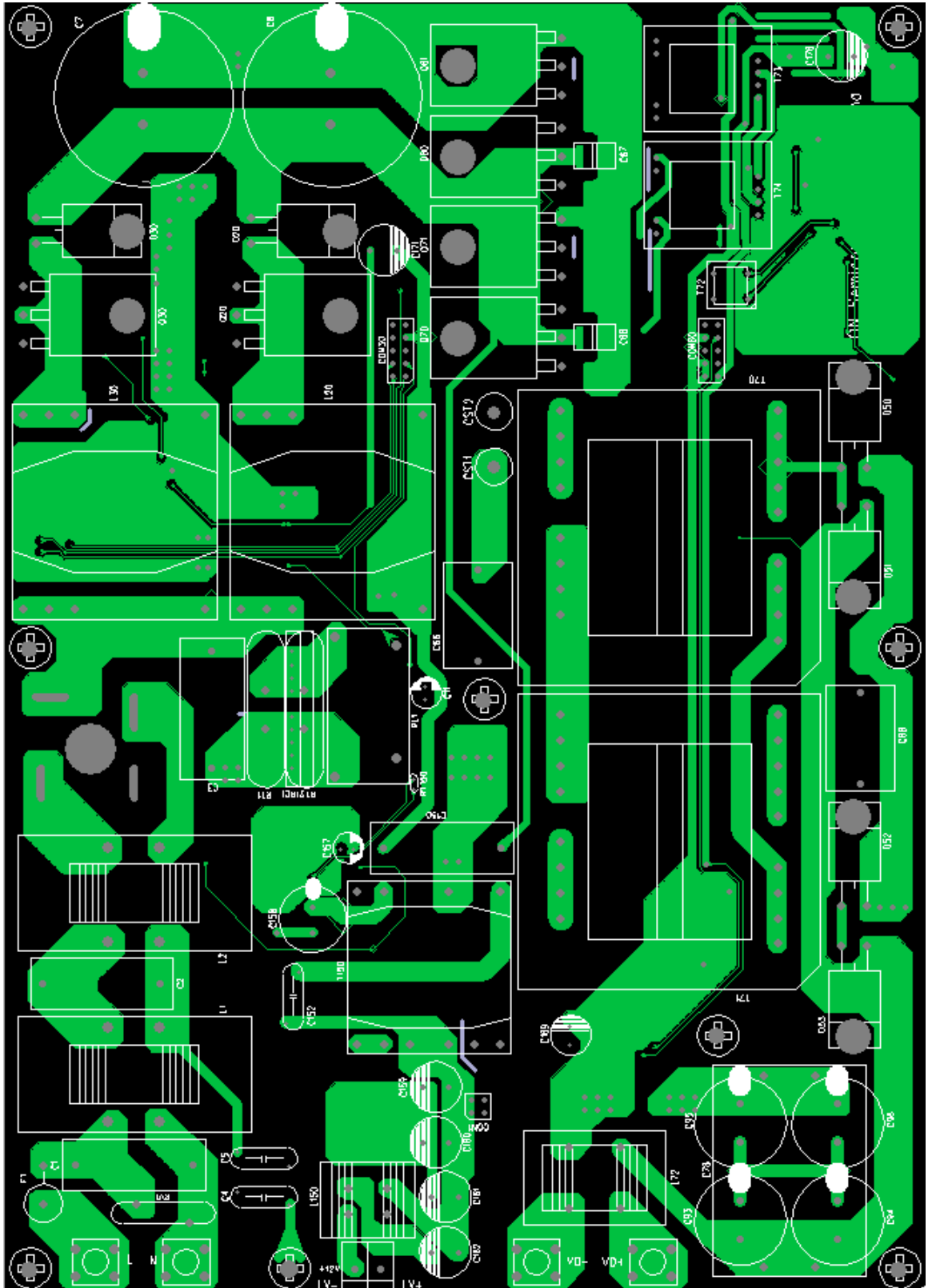

DN05107/D

Bottom side of main board

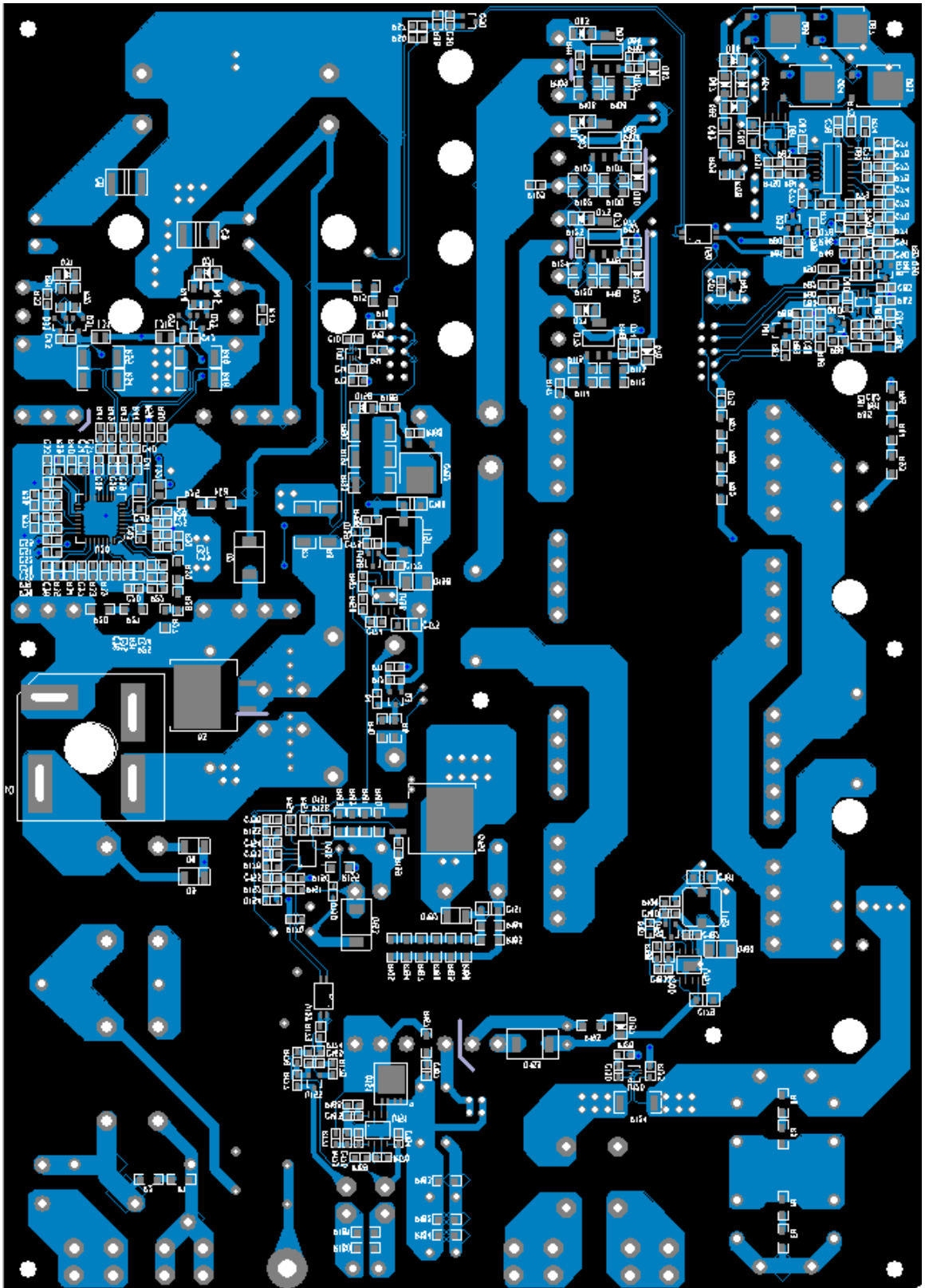

View through of main board

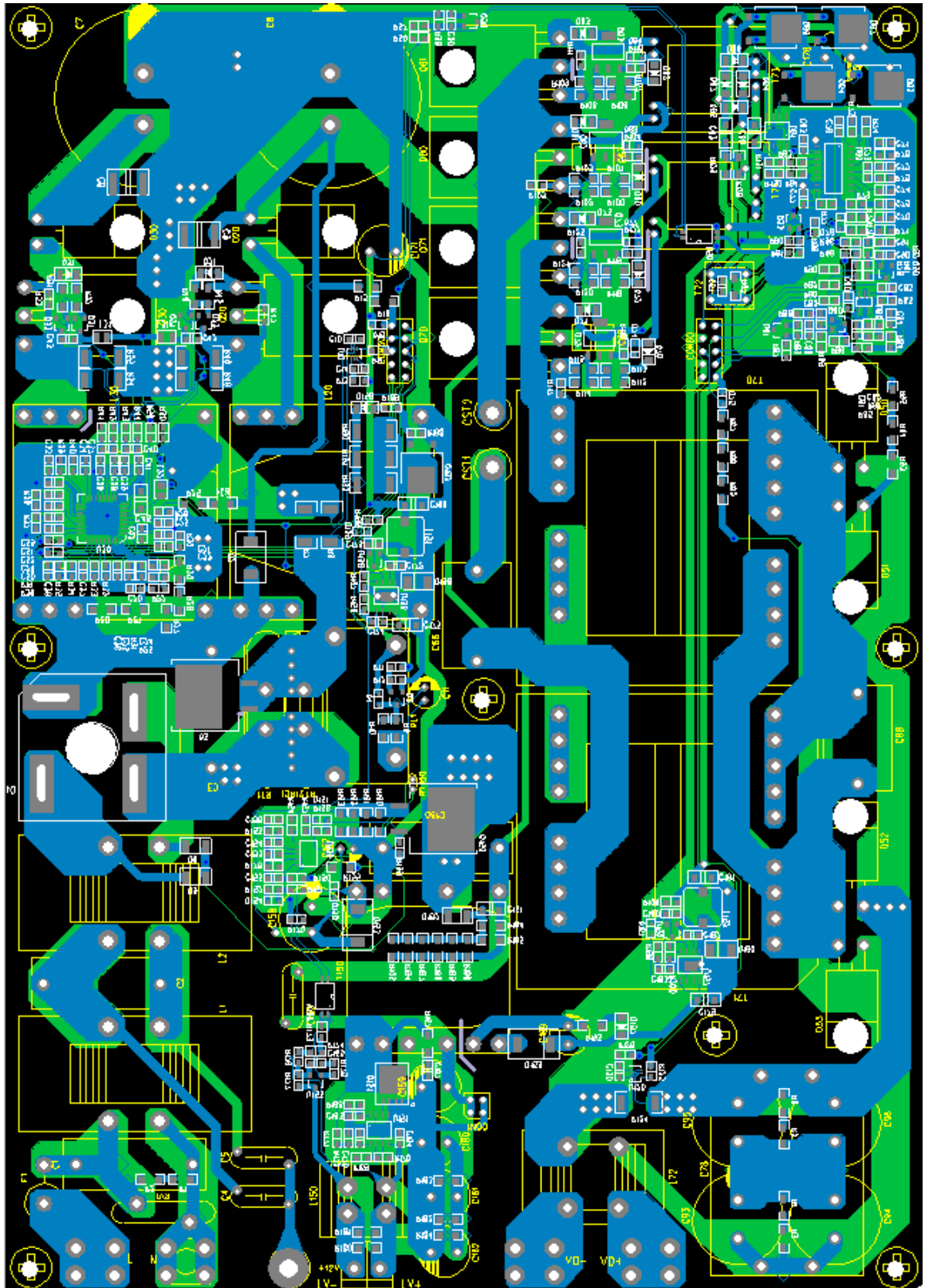

DN05107/D

Top side of manual control interface board. 163.1x 73.7x 1.2mm.

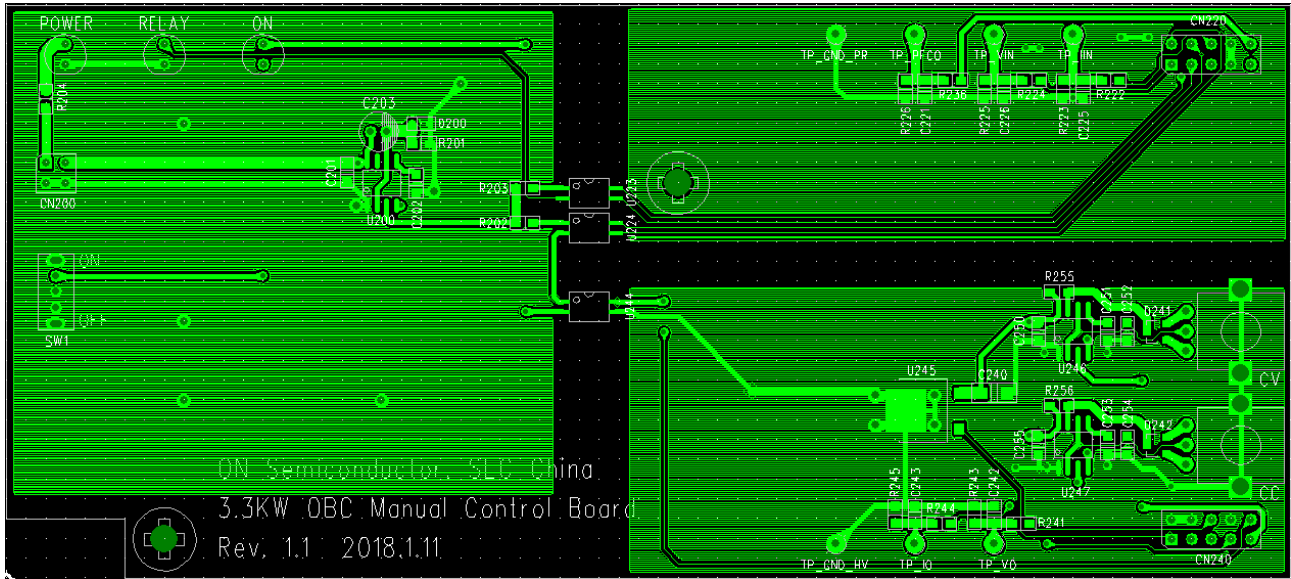

Bottom side of manual control interface board

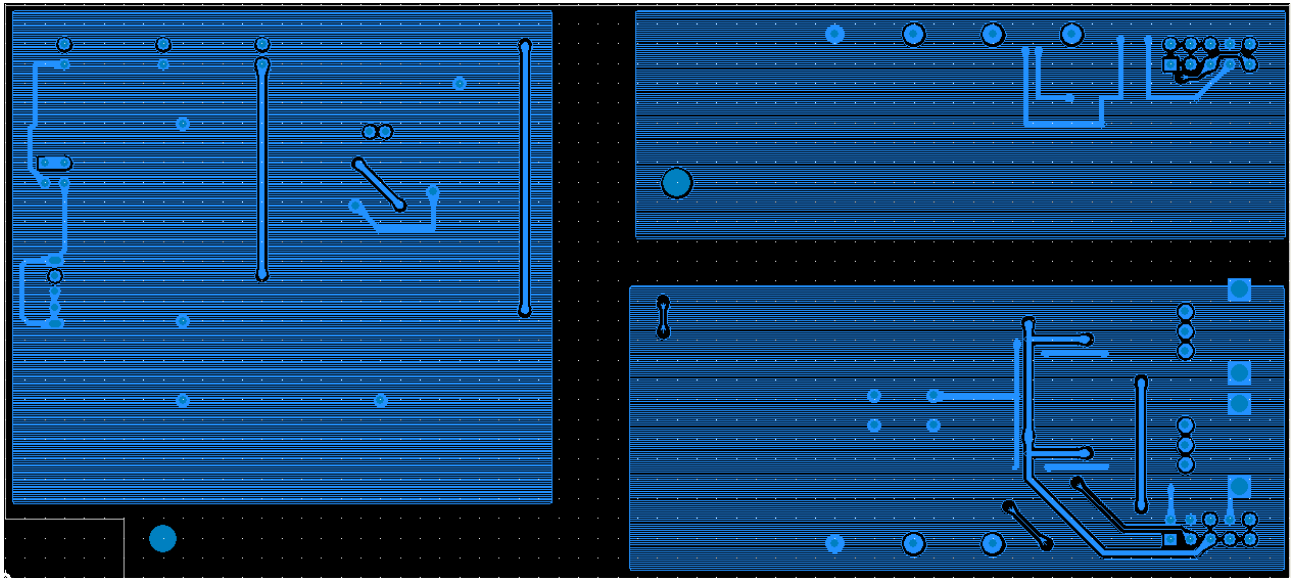

View through of manual control interface board

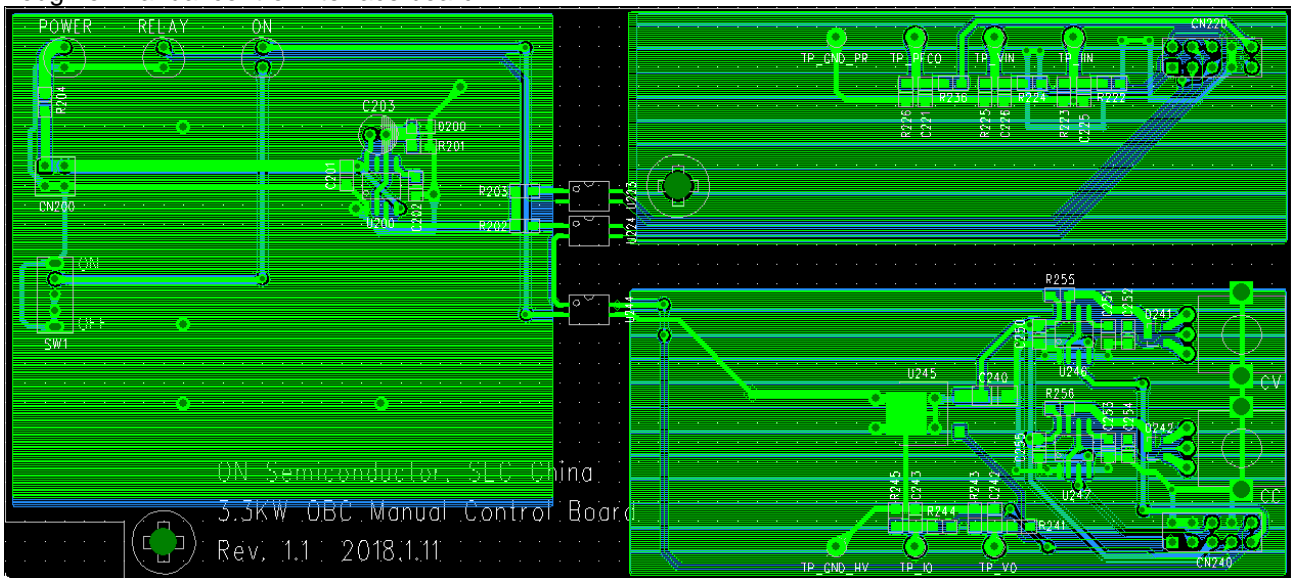

DN05107/D

Top, bottom side and view through of switch mode inrush current limit board. 45.7x 30.5x 1.6mm.

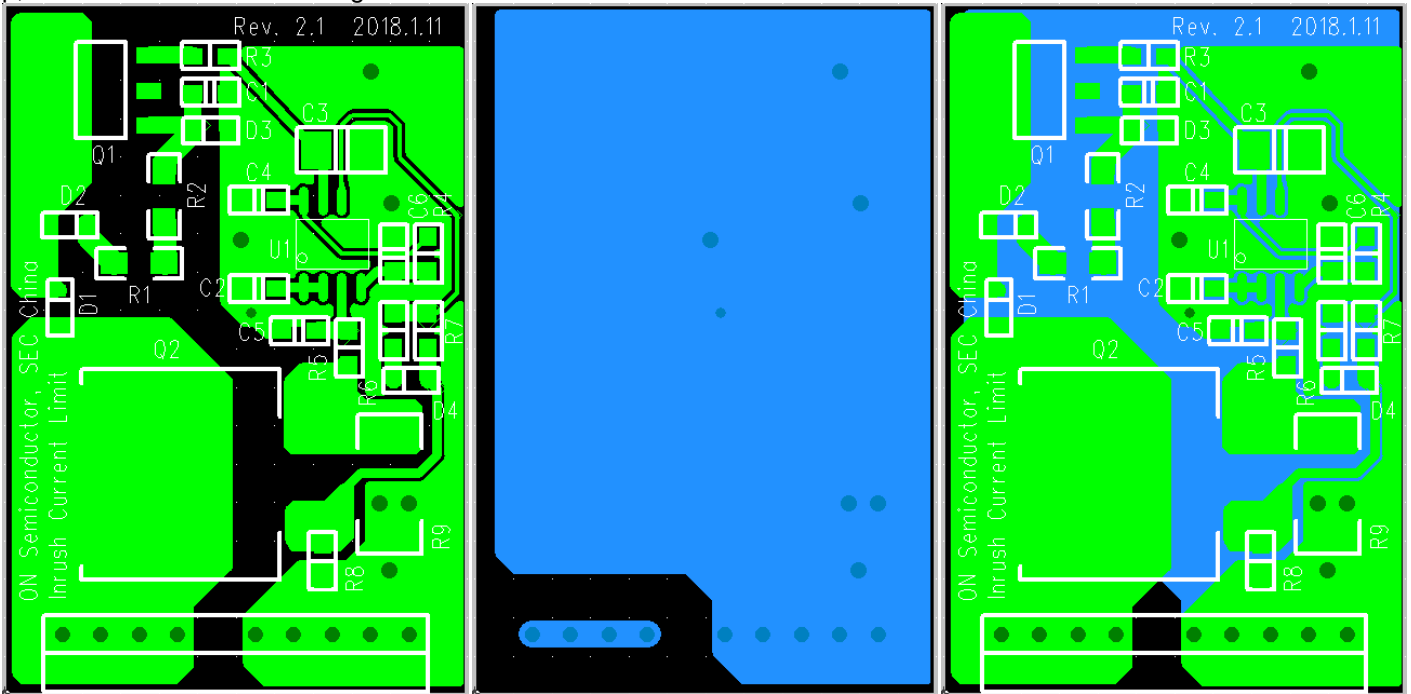

Bottom view and view through of bridge board. 28.2x 713.2x 1.6mm. Single layer.

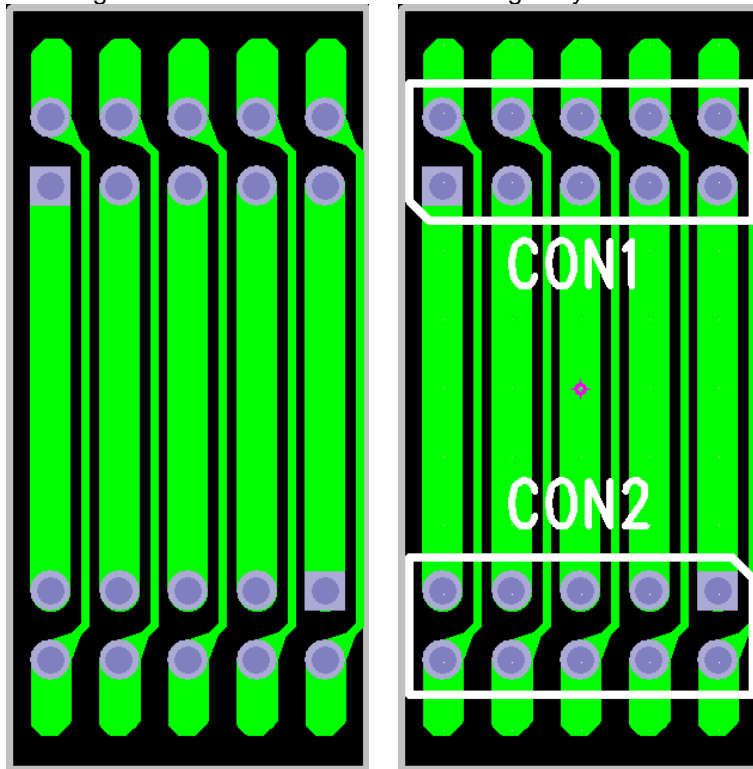

DN05107/D

Bill of Materials

Main board

| Description | Manufacturer Part Number | Manufacturer | Qty. | Designator |
|---------------------------------------|--------------------------|------------------|------|---|
| IC PWM Controller, QR, SOIC9 | NCP1340B3D1R2G | ON Semiconductor | 1 | U150, |
| IC ICCM PFC Controller, QFP32 | FAN9672Q | ON Semiconductor | 1 | U20, |
| IC Current mode LLC Controller, SOP16 | FAN7688SJX | ON Semiconductor | 1 | U60, |
| IC SR Controller, SO8 | FAN6224M | ON Semiconductor | 1 | U151, |
| IC Dual 4A Low-Side Gate Drivers, SO8 | FAN3224TUMX-F085 | ON Semiconductor | 1 | U61, |
| IC Buck Switcher, 1.2 A, 2 MHz, SO8EP | NCV890100PDR2G | ON Semiconductor | 2 | U156, U157, |
| IC 3.3V Voltage Reference, SOT-23 | NCV51460SN33T1G | ON Semiconductor | 2 | U158, U159, |
| IC Current Sense Amplifier, SC70-6 | NCV210SQT2G | ON Semiconductor | 2 | U10, U120, |
| IC RRO OP Amplifier, SOT-23 5L | NCV2003SN2T1G | ON Semiconductor | 1 | U80, |
| IC Shunt Regulator, SOT23-3L | SC431AVSNT1G | ON Semiconductor | 2 | U81, U153, |
| IC Photo Coupler High Temp, MFP-4L | FODM8801C | ON Semiconductor | 2 | U50, U152, |
| | | | | |
| MOSFET 259mΩ 800V, D2PAK | FCB290N80 | ON Semiconductor | 1 | Q150, |
| MOSFET 91mΩ 600V, TO-247 | FCH104N60F_F085 | ON Semiconductor | 4 | Q60, Q61, Q70, Q71, |
| MOSFET 2.4mΩ 60V, SO8-FL | NVMFS5C628NLT3G | ON Semiconductor | 1 | Q151, |
| MOSFET 68mΩ 650V, TO-247 | FCH077N65F_F085 | ON Semiconductor | 2 | Q20, Q30, |
| Transistor 40 V, 3.0 A PNP, SOT223 | NJT4030PT1G | ON Semiconductor | 4 | Q62, Q63, Q72, Q73, |
| Transistor 25 V 5A NPN, DPAK | MJD200G | ON Semiconductor | 2 | Q64, Q66, |
| Transistor 25 V 5A PNP, DPAK | MJD210G | ON Semiconductor | 2 | Q65, Q67, |
| Transistor 40 V 3A NPN, DPAK | NJVMJD31T4G | ON Semiconductor | 1 | Q152, |
| Transistor 40V 2A PNP, SOT23 | NSV40200LT1G | ON Semiconductor | 3 | Q22, Q32, Q53, |
| Transistor 40V 2A NPN, SOT23 | NSV40201LT1G | ON Semiconductor | 3 | Q3, Q21, Q31, |
| Transistor 40V 0.2A NPN, SOT23 | MMBT3904LT1G | ON Semiconductor | 1 | Q50, |
| MOSFET 60V 7.5Ω, SOT23 | 2V7002LT1G | ON Semiconductor | 2 | Q80, Q90, |
| | | | | |
| Bridge Rectifier 35A 600V, GBPC-4L | GBPC3506 | ON Semiconductor | 1 | D1, |
| FR Diode 16A 600V 60nS, D2PAK | NRVUB1660CTT4G | ON Semiconductor | 1 | D3, |
| SIC Diode 30A 650V, TO220 | FFSP3065A | ON Semiconductor | 6 | D20, D30, D50, D51, D52, D53, |
| Diode 1A 1000V, SMA | NRVA4007T3G | ON Semiconductor | 3 | D5, D6, D152, |
| Schottky Diode 3A 100V, SMC | NRVBS3100T3G | ON Semiconductor | 2 | D153, D155, |
| Schottky Diode 3A 40V, SMA | MBRA340T3G | ON Semiconductor | 2 | D158, D160, |
| Schottky Diode 1A 20V, SOD123 | NRVB120ESFT1G | ON Semiconductor | 14 | D21, D31, D60, D61, D62, D63, D64, D65, D66, D67, D70, D71, D72, D73, |
| Switching Diode 0.2A 100V, SOD323 | BAS16HT1G | ON Semiconductor | 13 | D4, D15, D68, D69, D74, D75, D76, D77, D150, D151, D154, D159, D161, |
| ZENER Diode 0.5W 22V, SOD123 | SZMMSZ22T1G | ON Semiconductor | 2 | D156, D157, |
| | | | | |
| Chip resistor 0805 0ohm-J | | Any | 1 | R68, |
| Chip resistor 0805 10ohm-J | | Any | 4 | R13, R80, R126, R157, |
| Chip resistor 0805 22ohm-J | | Any | 1 | R158, |
| Chip resistor 0805 47ohm-J | | Any | 4 | R104, R110, R116, R122, |
| Chip resistor 0805 82ohm-J | | Any | 2 | R197, R200, |
| Chip resistor 0805 100ohm-J | | Any | 2 | R150, R154, |
| Chip resistor 0805 220ohm-J | | Any | 2 | R50, R56, |

DN05107/D

| | | | | |
|-------------------------------|---------------|------|----|--|
| Chip resistor 0805 470ohm-J | | Any | 6 | R41, R42, R43, R44, R188, R189, |
| Chip resistor 0805 1Kohm-J | | Any | 4 | R63, R64, R130, R131, |
| Chip resistor 0805 1.2Kohm-J | | Any | 1 | R199, |
| Chip resistor 0805 1.5Kohm-J | | Any | 1 | R196, |
| Chip resistor 0805 2.2Kohm-J | | Any | 7 | R59, R60, R61, R86, R151, R153, R173, |
| Chip resistor 0805 3Kohm-J | | Any | 1 | R87, |
| Chip resistor 0805 4.7Kohm-J | | Any | 1 | R174, |
| Chip resistor 0805 4.75Kohm-F | | Any | 7 | R36, R82, R83, R89, R91, R92, R125, |
| Chip resistor 0805 5.1Kohm-J | | Any | 1 | R71, |
| Chip resistor 0805 8.2Kohm-J | | Any | 3 | R11, R12, R35, |
| Chip resistor 0805 10Kohm-J | | Any | 20 | R19, R39, R47, R53, R57, R69, R75, R81, R84, R85, R90, R105, R111, R117, R123, R156, R159, R175, R177, R198, |
| Chip resistor 0805 12.4Kohm-F | | Any | 4 | R33, R34, R78, R172, |
| Chip resistor 0805 12.7Kohm-F | | Any | 2 | R14, R26, |
| Chip resistor 0805 15Kohm-J | | Any | 1 | R74, |
| Chip resistor 0805 18Kohm-J | | Any | 4 | R30, R37, R38, R70, |
| Chip resistor 0805 27Kohm-J | | Any | 1 | R170, |
| Chip resistor 0805 33Kohm-J | | Any | 3 | R31, R88, R96, |
| Chip resistor 0805 36Kohm-J | | Any | 2 | R23, R72, |
| Chip resistor 0805 39Kohm-J | | Any | 3 | R32, R176, R179, |
| Chip resistor 0805 43Kohm-J | | Any | 1 | R169, |
| Chip resistor 0805 47Kohm-J | | Any | 1 | R40, |
| Chip resistor 0805 68Kohm-J | | Any | 1 | R77, |
| Chip resistor 0805 75Kohm-J | | Any | 1 | R168, |
| Chip resistor 0805 100Kohm-J | | Any | 1 | R98, |
| Chip resistor 0805 120Kohm-J | | Any | 1 | R171, |
| Chip resistor 0805 200Kohm-J | | Any | 4 | R22, R73, R79, R178, |
| Chip resistor 0805 360Kohm-J | | Any | 1 | R152, |
| Chip resistor 1206 0ohm-J | | Any | 4 | R102, R108, R114, R120, |
| Chip resistor 1206 0.62ohm-J | | Any | 4 | R160, R161, R162, R163, |
| Chip resistor 1206 1ohm-J | | Any | 2 | R128, R129, |
| Chip resistor 1206 2.2ohm-J | | Any | 1 | R167, |
| Chip resistor 1206 4.7ohm-J | | Any | 8 | R100, R101, R106, R107, R112, R113, R118, R119, |
| Chip resistor 1206 10ohm-J | | Any | 4 | R45, R46, R51, R52, |
| Chip resistor 1206 68ohm-J | | Any | 1 | R97, |
| Chip resistor 1206 82ohm-J | | Any | 1 | R193, |
| Chip resistor 1206 1Kohm-J | | Any | 2 | R9, R10, |
| Chip resistor 1206 1.5Kohm-J | | Any | 2 | R180, R181, |
| Chip resistor 1206 4.7Kohm-J | | Any | 1 | R155, |
| Chip resistor 1206 220Kohm-J | | Any | 4 | R3, R4, R5, R6, |
| Chip resistor 1206 330Kohm-J | | Any | 3 | R93, R94, R95, |
| Chip resistor 1206 470Kohm-J | | Any | 6 | R164, R165, R166, R185, R186, R187, |
| Chip resistor 1206 750Kohm-J | | Any | 3 | R65, R66, R67, |
| Chip resistor 1206 1Mohm-J | | Any | 6 | R15, R16, R20, R21, R24, R25, |
| Chip resistor 1206 2Mohm-F | | Any | 3 | R27, R28, R29, |
| Chip resistor 2512 2mohm-F | SMA25A2FR002T | SART | 3 | R7, R8, R124, |
| Chip resistor 2512 30mohm-J | SK25G1FR030T | SART | 2 | R49, R55 |

DN05107/D

| | | | | |
|---------------------------------------|----------------------|-------|---|---|
| Chip resister 2512 20mohm-J | SK25G1FR020T | SART | 2 | R48, R54, |
| Chip resister 2512 470ohm-J | | Any | 3 | R190, R191, R192, |
| NTC 100Kohm 1%, AEC-Q200 | B57540G1104F000 | TDK | 1 | RT150, |
| Disk Varistor 320V D20 | 820423211 | WURTH | 1 | RV1 |
| MLCC 0805-50V-10pFK-NP0 | '885012007051 | WURTH | 3 | C70, C154, C170, |
| MLCC 0805-50V-100pFK-NP0 | 885012007057 | WURTH | 3 | C30, C32, C156, |
| MLCC 0805-450V-100pFK-NP0 | CGA4C4C0G2W101J060AA | TDK | 3 | C30, C32, C156, |
| MLCC 0805-50V-220pFK-NP0 | 885012007059 | WURTH | 1 | C77, |
| MLCC 0805-450V-220pFK-NP0 | CGA4C4C0G2W221J060AA | TDK | 1 | C77, |
| MLCC 0805-50V-471J-NP0 | 885012007061 | WURTH | 8 | C23, C26, C27, C34, C71, C75, C82, C155, |
| MLCC 0805-450V-471J-NP0 | CGA4C4C0G2W471J060AA | TDK | 8 | C23, C26, C27, C34, C71, C75, C82, C155, |
| MLCC 0805-50V-102M-X7R | 885012207086 | WURTH | 8 | C29, C31, C37, C40, C61, C83, C163, C167, |
| MLCC 0805-100V-102M-X7R | CGA4C2C0G2A102J060AA | TDK | 8 | C29, C31, C37, C40, C61, C83, C163, C167, |
| MLCC 0805-50V-222M-X7R | 885012207088 | WURTH | 6 | C36, C38, C39, C41, C174, C183, |
| MLCC 0805-50V-222M-X7R | CGA4C2C0G1H222J060AA | TDK | 6 | C36, C38, C39, C41, C174, C183, |
| MLCC 0805-50V-472M-X7R | '885012207090 | WURTH | 1 | C72, |
| MLCC 0805-50V-472M-X7R | CGA4C2C0G1H472J060AA | TDK | 1 | C72, |
| MLCC 0805-50V-103M-X7R | 885012207092 | WURTH | 7 | C25, C28, C33, C35, C50, C81, C153, |
| MLCC 0805-50V-103M-X7R | CGA4C2C0G1H103J060AA | TDK | 7 | C25, C28, C33, C35, C50, C81, C153, |
| MLCC 0805-50V-473M-X7R | '885012207096 | WURTH | 3 | C20, C76, C165, |
| MLCC 0805-100V-473M-X7R | CGA4J2X7R2A473M125AA | TDK | 3 | C20, C76, C165, |
| MLCC 0805-25V-104M-X7R | 885012207072 | WURTH | 9 | C14, C22, C80, C86, C120, C172, C175, C180, C182, |
| MLCC 0805-100V-104M-X7R | CGA4J2X7R2A104K125AA | TDK | 9 | C14, C22, C80, C86, C120, C172, C175, C180, C182, |
| MLCC 0805-25V-224M-X7R | 885012207074 | WURTH | 2 | C24, C73, |
| MLCC 0805-25V-224M-X7R | CGA4J2X7R1H224K125AA | TDK | 2 | C24, C73, |
| MLCC 0805-25V-474M-X7R | 885012207076 | WURTH | 6 | C21, C42, C43, C63, C92, C164, |
| MLCC 0805-25V-474M-X7R | CGA4J2X7R1E474K125AA | TDK | 6 | C21, C42, C43, C63, C92, C164, |
| MLCC 0805-25V-225M-X7R | '885012207079 | WURTH | 2 | C84, C91, |
| MLCC 0805-25V-225M-X7R | CGA4J3X7R1E225K125AB | TDK | 2 | C84, C91, |
| MLCC 0805-16V-475M-X7R | '885012207052 | WURTH | 1 | C74, |
| MLCC 0805-16V-475M-X7R | CGA4J3X7R1C475K125AB | TDK | 1 | C74, |
| MLCC 1206-25V-106M-X7R | 885012208069 | WURTH | 3 | C46, C166, C181 |
| MLCC 1206-25V-106M-X7R | CGA5L1X7R1E106K160AC | TDK | 3 | C46, C166, C181 |
| MLCC 1206-50V-475M-X7R | 885012208094 | WURTH | 4 | C60, C62, C173, C179 |
| MLCC 1206-630V-222M-X7R | CGA5H4X7R2J222K115AA | TDK | 1 | C151, |
| MLCC 2220-630V-105M-X7T | CKG57NX7T2J105M500JJ | TDK | 4 | C6, C9, C67, C68, |
| E-Cap 25V-150uF-105(6.3X11mm) | 860020473010 | WURTH | 1 | C11, |
| E-Cap 35V-82uF-105-10Kh(6.3X15mm) | 860160573010 | WURTH | 1 | C157, |
| E-Cap 35V-220uF-105-LI(8X16mm) | 86080574011 | WURTH | 1 | C169, |
| E-Cap 35V-1500uF-105-LI(13X35mm) | 860080578024 | WURTH | 1 | C158, |
| E-Cap 25V-560uF-105-LI(10X20mm) | 860080475017 | WURTH | 6 | C159, C160, C161, C162, C171, C176, |
| E-Cap 250V-150uF-105-10Kh (18X31.5mm) | 860241181007 | WURTH | 4 | C93, C94, C95, C96, |
| E-Cap 450V-680uF-105 (35X57mm) | 861141486026 | WURTH | 2 | C7, C8, |

DN05107/D

| | | | | |
|--|----------------------|-----------|---|-----------------|
| Film Cap 630V 1uF PP | ECWFD2J105K | Panasonic | 1 | C150, |
| Film Cap 630V 2.2uF PP | ECWFD2J225K | Panasonic | 1 | C3, |
| Film Cap 1600V 47nF MPP | ECWHA3C473J | Panasonic | 2 | C66, C69, |
| Film Cap 800V 20uF PP | EZPE80206MTA | Panasonic | 1 | C78, |
| X-Cap 275VAC 1uF X2 | 890324026027CS | WURTH | 2 | C1, C2, |
| X-Cap 275VAC 1uF X2 | ECQUAAF105K | Panasonic | 2 | C1, C2, |
| Y-Cap 400VAC 4700pF Y2 | CD45-E2GA472M-NKA | TDK | 3 | C4, C5, C152, |
| | | | | |
| Common Choke 1.0mH 25A | 7448262510 | WURTH | 2 | L1, L2 |
| Common Choke 47uH 15A | 744844470 | WURTH | 1 | L72, |
| Common Choke 16uH 10A | 7448421016 | WURTH | 1 | L150, |
| Aux. Transformer PQ3230, 12-Pin, THT. | 750343613 | WURTH | 1 | T150, |
| LLC Transformer EPC54 | | HNDJ | 2 | T70, T71, |
| Current Transformer EE8 | 750343741 | WURTH | 1 | T72, |
| Pulse Transformer EF20/10/6, THT | 750343786 | WURTH | 2 | T73, T74, |
| SMD Inductor 7X7X3.5mm-22uH-1.6A | 784778220 | WURTH | 2 | L151, L152, |
| SMD Inductor 7X7X4.5mm-22uH-1.7A | SPM7045VT-220M-D | TDK | 2 | L151, L152, |
| Chip Inductor 2016-1uH | 74438343010 | WURTH | 3 | L21, L22, L31, |
| Chip Inductor 2016-1uH Automotive | TFM201610ALMA1R0MTAA | TDK | 3 | L21, L22, L31, |
| PFC Inductor PQ4040 150uH | 750343627 | WURTH | 2 | L20, L30, |
| | | | | |
| Connector 5mm 2Pins Screw type | 691101710002 | WURTH | 1 | 12V |
| Connector 5mm Screw type. 200X300mil | 74760050 | WURTH | 4 | VO+, VO-, L, N, |
| Connector 2.54mm Dual Socket Header 4Pns | 61300421821 | WURTH | 1 | CON1, |
| Connector 2.54mm Dual Socket Header 10Pns | 61301021821 | WURTH | 2 | CON30, CON60, |
| | | | | |
| RELAY 25A 250VAC | PCF-11202M | OEG | 1 | RL1 |
| RELAY 20A 250VAC | ALF1P12 | Panasonic | 1 | RL1 |
| Spacer Plastic, metric, internal/external, 8mm | 971080365 | WURTH | 6 | |
| Spacer Brass, metric, internal/external, 8mm | 971080324 | WURTH | 1 | |
| FUSE 30A 250V 6X30mm | | Any | 1 | F1 |

* The adjacent items in same shadow are optional in different manufacturer.

Manual control interface board.

| Description | Manufacturer Part Number | Manufacturer | Qty. | Designator |
|------------------------------------|--------------------------|------------------|------|-------------------------------------|
| IC Single Timer, SO8 | NCV1455BDR2G | ON Semiconductor | 3 | U200, U246, U247, |
| IC 5V 0.5A Voltage Regulator, DPAK | NCV78M05BDTRKG | ON Semiconductor | 1 | U245, |
| Photo Coupler High Temp MFP-4L | FODM8801C | ON Semiconductor | 3 | U223, U224, U244, |
| Switching Diode 0.2A 100V, SOD323 | BAS16HT1G | ON Semiconductor | 1 | D200, |
| Schottky Diode 0.2A 100V, SOT23 | SBAV99LT3G | ON Semiconductor | 2 | D241, D242, |
| LED D=5mm THT Green | 151051VS04000 | WURTH | 2 | POWER, RELAY, |
| LED D=5mm THT Red | 151051RS11000 | WURTH | 1 | ON, |
| | | | | |
| Chip resistor 0805 1Kohm-J | | Any | 3 | R202, R255, R256, |
| Chip resistor 0805 2.2Kohm-J | | Any | 2 | R203, R204, |
| Chip resistor 0805 2.43Kohm-F | | Any | 2 | R222, R224, |
| Chip resistor 0805 12.4Kohm-F | | Any | 6 | R223, R225, R226, R243, R244, R245, |

DN05107/D

| | | | | |
|---|----------------------|-------|---|--|
| Chip resistor 0805 100Kohm-J | | Any | 2 | R236, R241, |
| Chip resistor 0805 150Kohm-J | | Any | 1 | R201, |
| Potentiometer 50Kohm 10X11mm Vertical | | Any | 2 | CC, CV, |
| | | | | |
| MLCC 0805-50V-102M-X7R | 885012207086 | WURTH | 5 | C221, C225, C226, C242, C243, |
| MLCC 0805-100V-102M-X7R | CGA4C2C0G2A102J060AA | TDK | 5 | C221, C225, C226, C242, C243, |
| MLCC 0805-50V-222M-X7R | 885012207088 | WURTH | 2 | C252, C254, |
| MLCC 0805-50V-222M-X7R | CGA4C2C0G1H222J060AA | TDK | 2 | C252, C254, |
| MLCC 0805-50V-103M-X7R | 885012207092 | WURTH | 3 | C202, C251, C253, |
| MLCC 0805-50V-103M-X7R | CGA4C2C0G1H103J060AA | TDK | 3 | C202, C251, C253, |
| MLCC 0805-25V-104M-X7R | 885012207072 | WURTH | 3 | C201, C250, C255, |
| MLCC 0805-100V-104M-X7R | CGA4J2X7R2A104K125AA | TDK | 3 | C201, C250, C255, |
| MLCC 1206-25V-106M-X7R | 885012208069 | WURTH | 1 | C240, |
| MLCC 1206-25V-106M-X7R | CGA5L1X7R1E106K160AC | TDK | 1 | C240, |
| E-Cap 35V-10uF-105(5X11mm) | 860020572003 | WURTH | 1 | C203, |
| | | | | |
| 2.54mm Dual Socket Header 4Pns | 61300421821 | WURTH | 1 | CON200, |
| 2.54mm Dual Socket Header 10Pns | 61301021821 | WURTH | 2 | CON220, CON240, |
| Test Pin | | Any | 7 | TP_PFCO, TP_IIN, TP_VIN, TP_GND_PR, TP_GND_HV, TP_IO, TP_VO, |
| Switch 1 Connector 2 Position, 8.6X4.4mm | | Any | 1 | SW1, |
| Spacer Plastic, metric, internal/external, 15mm | 971150365 | WURTH | 6 | |

* The adjacent items in same shadow are optional in different manufacturer.

Switch mode inrush current limit board.

| Description | Manufacturer Part Number | Manufacturer | Qty. | Designator |
|------------------------------------|--------------------------|------------------|------|-------------|
| IC Current Mode PWM Controller SO8 | NCV3843BVD1R2G | ON Semiconductor | 1 | U1, |
| MOSFET 11.5Ω 600V QFET, SOT223 | FQT1N60CTF-WS | ON Semiconductor | 1 | Q1, |
| MOSFET 173m Ω 600V SuperFET, D2PAK | FCB20N60-F085 | ON Semiconductor | 1 | Q2, |
| Switching Diode 0.2A 100V, SOD323 | BAS16HT1G | ON Semiconductor | 3 | D1, D2, D4, |
| ZENER Diode 0.5W 15V, SOD323 | MM5Z15VT1G | ON Semiconductor | 1 | D3, |
| | | | | |
| Chip resistor 0805 4.7ohm-J | | Any | 1 | R6, |
| Chip resistor 0805 10ohm-J | | Any | 2 | R7, |
| Chip resistor 0805 22ohm-J | | Any | 1 | R3, |
| Chip resistor 0805 1Kohm-J | | Any | 1 | R5, |
| Chip resistor 0805 22Kohm-J | | Any | 1 | R8, |
| Chip resistor 0805 100Kohm-J | | Any | 1 | R4, |
| Chip resistor 1206 330Kohm-J | | Any | 2 | R1, R2, |
| Chip resistor 2512 0.1ohm-F | | Any | 1 | R9, |
| | | | | |
| MLCC 0805-50V-100pFK-NP0 | 885012007057 | WURTH | 2 | C5, C6, |
| MLCC 0805-450V-100pFK-NP0 | CGA4C4C0G2W101J060AA | TDK | 2 | C5, C6, |
| MLCC 0805-50V-103M-X7R | 885012207092 | WURTH | 1 | C2, |
| MLCC 0805-50V-103M-X7R | CGA4C2C0G1H103J060AA | TDK | 1 | C2, |
| MLCC 0805-25V-105M-X7R | 885012207078 | WURTH | 2 | C1, C4, |

DN05107/D

| | | | | |
|---------------------------|----------------------|-------|---|-----------------|
| MLCC 0805-25V-105M-X7R | CGA4J3X7R1E105K125AB | TDK | 2 | C1, C4, |
| MLCC 1206-25V-106M-X7R | 885012208069 | WURTH | 3 | C46, C166, C181 |
| MLCC 1206-25V-106M-X7R | CGA5L1X7R1E106K160AC | TDK | 3 | C46, C166, C181 |
| | | | | |
| 2.54mm Header 10Pns 90Deg | 61301011021 | WURTH | 1 | |

* The adjacent items in same shadow are optional in different manufacturer.

Bridge board.

| Description | Manufacturer Part Number | Manufacturer | Qty. | Designator |
|---------------------------------------|--------------------------|--------------|------|-------------|
| 2.54mm THT Angled Dual Pin Header 10P | 61301021021 | WURTH | 2 | CON1, CON2, |