

# MMIC Amplifier

3 V, 16 mA, 0.1 to 3.6 GHz, MCPH6

## SMA3109

### Features

- High Gain:  $G_p = 23$  dB Typ. @ 1 GHz
- Wideband Response:  $f_u = 3.6$  GHz
- Low current:  $I_{CC} = 16$  mA Typ
- High Output Power:  $P_o(1dB) = 4$  dBm
- Port Impedance: Input/Output  $50 \Omega$
- This is a Pb-Free Device

### Specifications

#### ABSOLUTE MAXIMUM RATINGS (Ta = 25°C)

Symbol	Parameter	Ratings	Unit
V <sub>CC</sub>	Supply Voltage	5	V
I <sub>CC</sub>	Circuit Current	25	mA
P <sub>D</sub>	Allowable Power Dissipation	280	mW
Topr	Operating Temperature	-40 to +85	°C
Tstg	Storage Temperature	-55 to +150	°C

Stresses exceeding those listed in the Maximum Ratings table may damage the device. If any of these limits are exceeded, device functionality should not be assumed, damage may occur and reliability may be affected.

#### RECOMMENDED OPERATING CONDITIONS (Ta = 25°C)

Symbol	Parameter	Ratings			Unit
		Min	Typ	Max	
V <sub>CC</sub>	Supply Voltage	2.7	3	3.3	V
Topr	Operating Ambient Temperature	-40	+25	+85	°C

Functional operation above the stresses listed in the Recommended Operating Ranges is not implied. Extended exposure to stresses beyond the Recommended Operating Ranges limits may affect device reliability.

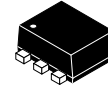

SC-88FL / MCPH6  
CASE 419AS

### MARKING DIAGRAM

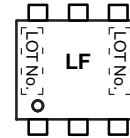

### PIN DESCRIPTION

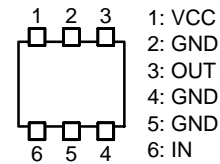

### ORDERING INFORMATION

See detailed ordering and shipping information on page 5 of this data sheet.

# SMA3109

## ELECTRICAL CHARACTERISTICS (Ta = 25°C, VCC = 3 V, ZS = ZL = 50 Ω)

Symbol	Parameter	Conditions	Ratings			Unit
			Min	Typ	Max	
I <sub>CC</sub>	Circuit Current		11.5	16.0	20.5	mA
G <sub>p</sub>	Power Gain	f = 1 GHz	21.0	23.0	26.0	dB
		f = 2.2 GHz	22.0	24.0	27.0	
ISL	Isolation	f = 1 GHz	27.0	31.5	–	dB
		f = 2.2 GHz	27.0	31.5	–	
RL <sub>in</sub>	Input Return Loss	f = 1 GHz	16.0	20.5	–	dB
		f = 2.2 GHz	10.0	15.0	–	
RL <sub>out</sub>	Output Return Loss	f = 1 GHz	15.0	20.0	–	dB
		f = 2.2 GHz	10.0	14.0	–	
NF	Noise Figure	f = 1 GHz	–	4.3	5.0	dB
		f = 2.2 GHz	–	4.3	5.0	
Po(1dB)	Gain 1 dB Compression Output Power	f = 1 GHz	4.0	6.4	–	dBm
		f = 2.2 GHz	2.0	4.2	–	
f <sub>u</sub>	Upper Limit Operating Frequency	3 dB down below flat gain at f = 1 GHz	–	3.6	–	GHz

Product parametric performance is indicated in the Electrical Characteristics for the listed test conditions, unless otherwise noted. Product performance may not be indicated by the Electrical Characteristics if operated under different conditions.

NOTE: Pay attention to handling since it is liable to be affected by static electricity due to the high frequency process adopted.

### Test Circuit

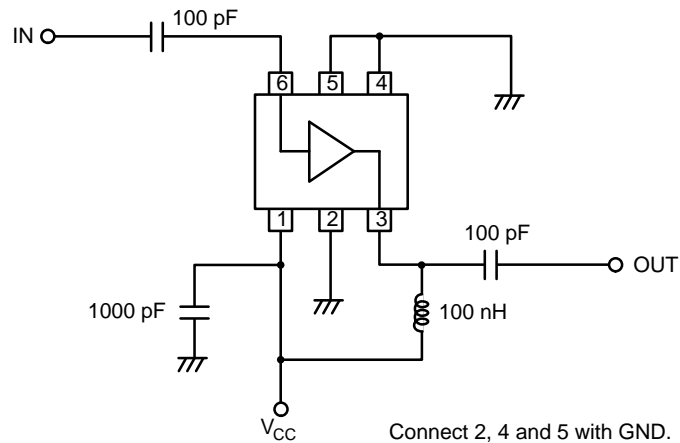

Figure 1. Test Circuit

# SMA3109

## Design of the Evaluation Board

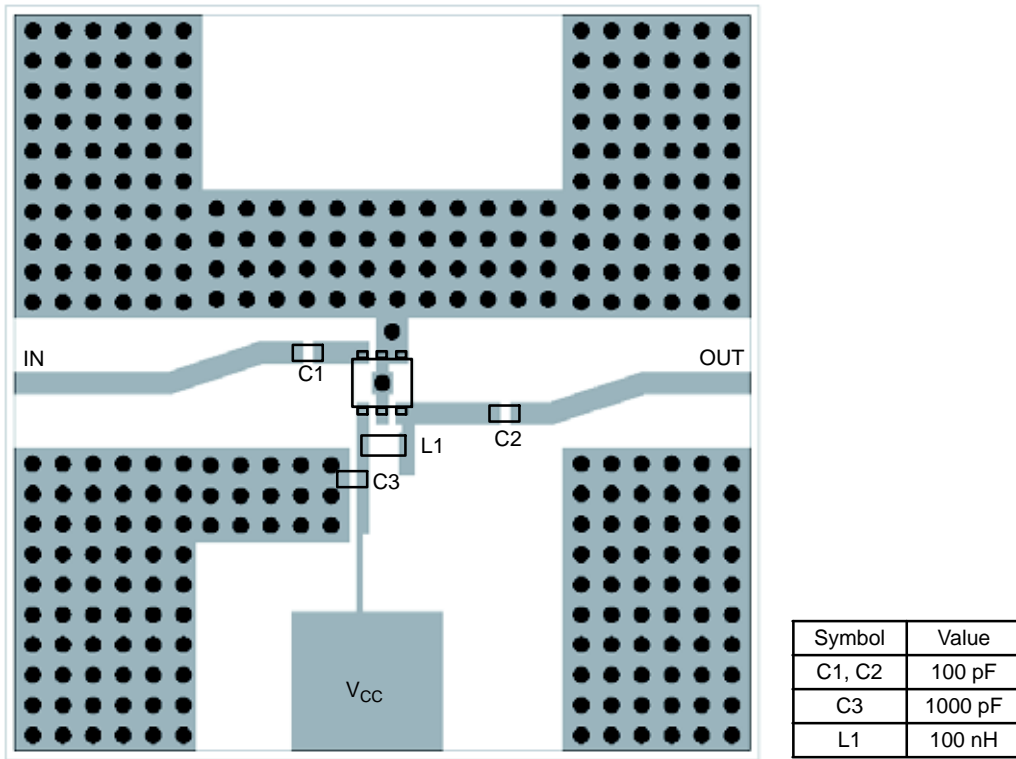

Figure 2. Design of the Evaluation Board

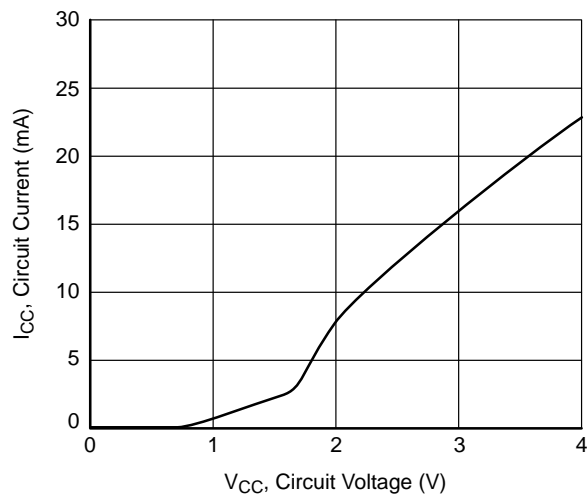

Figure 3. I<sub>CC</sub> – V<sub>CC</sub>

# SMA3109

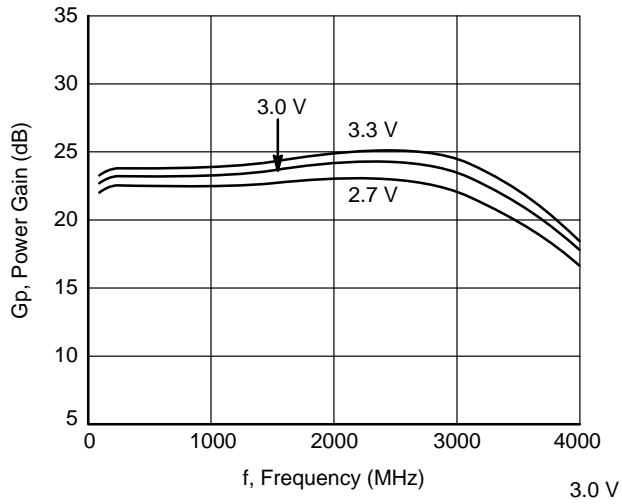

Figure 4. Gp - f

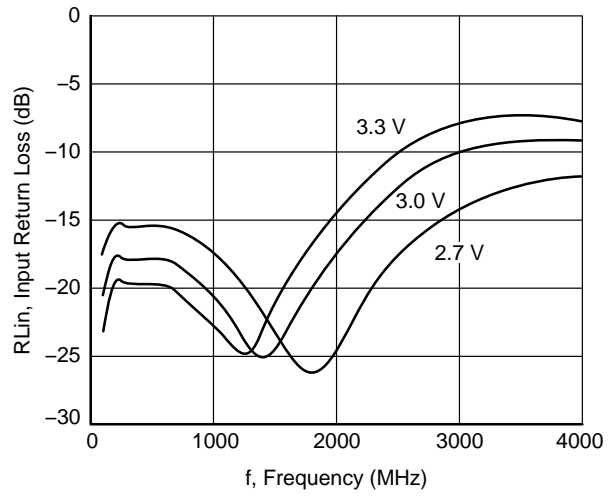

Figure 5. RLIn - f

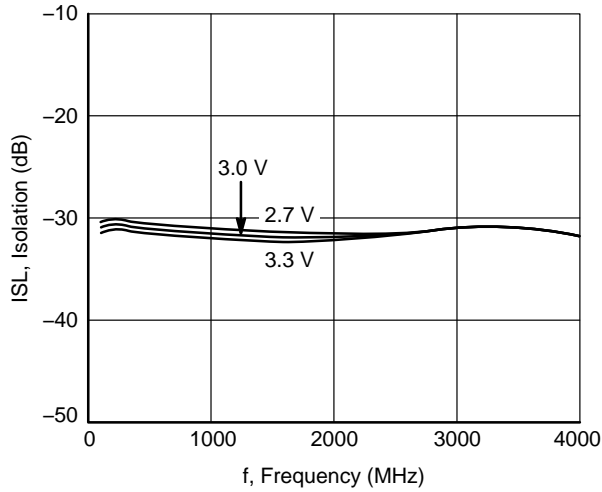

Figure 6. ISL - f

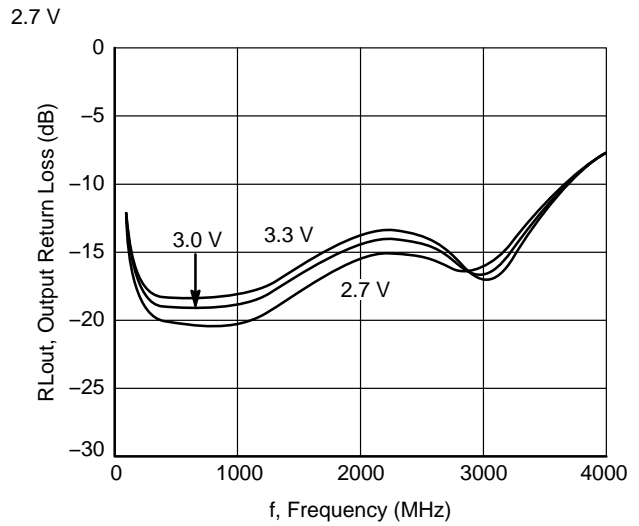

Figure 7. RLout - f

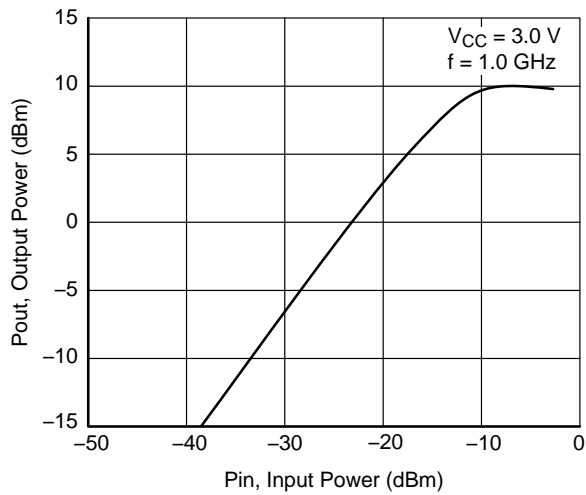

Figure 8. Pout - Pin

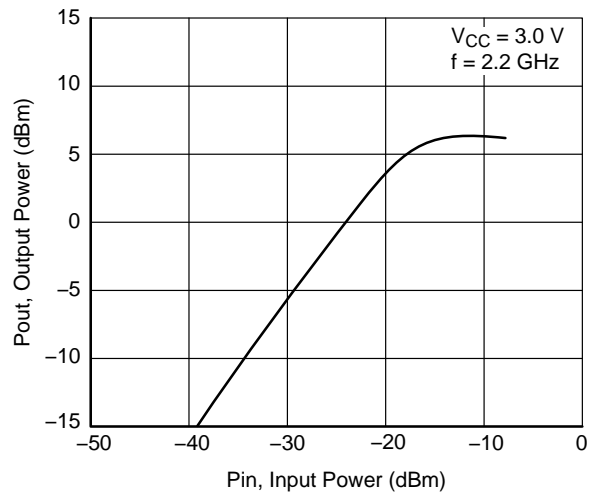

Figure 9. Pout - Pin

# SMA3109

## S Parameter

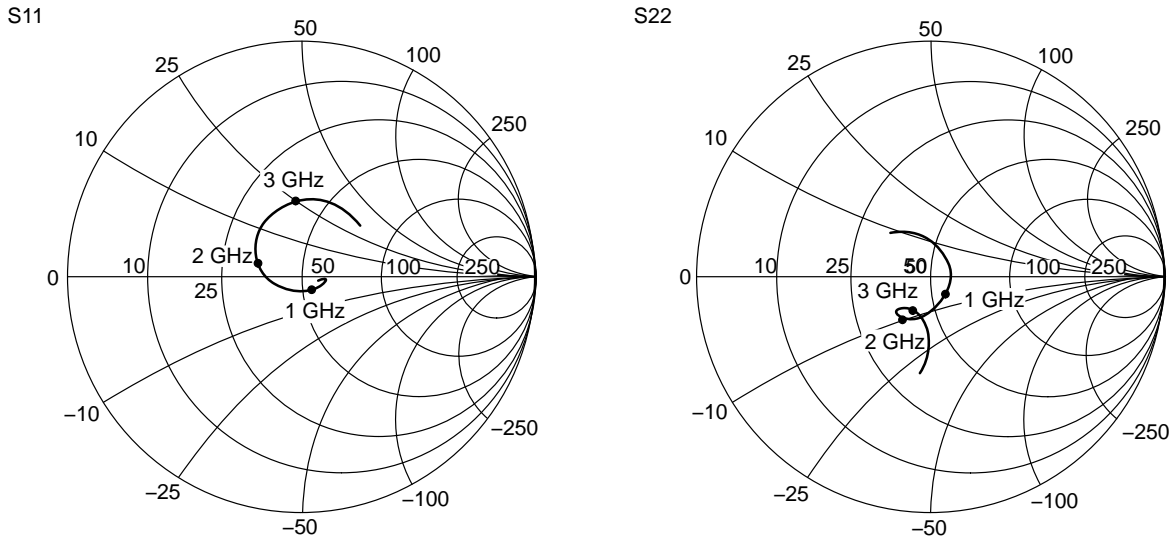

Figure 10. S Parameter

## ORDERING INFORMATION

Device	Specific Device Marking	Package Type (JEITA, JEDEC)	Package Type	Shipping†
SMA3109-TL-E	LF	SC-88FL (Pb-Free)	MCPH6 (Pb-Free)	3000 / Tape & Reel

†For Information On Tape And Reel Specifications, Including Part Orientation And Tape Sizes, Please Refer To Our Tape And Reel Packaging Specifications Brochure, Brd8011/D.

# MECHANICAL CASE OUTLINE

## PACKAGE DIMENSIONS



SC-88FL / MCPH6  
CASE 419AS  
ISSUE A

DATE 28 SEP 2022



NOTES:

1. NO INDUSTRY STANDARD APPLIES TO THIS PACKAGE.
2. ALL DIMENSIONS ARE IN MILLIMETERS.
3. DIMENSIONS ARE EXCLUSIVE OF BURRS, MOLD FLASH AND THE BAR PROTRUSIONS.

DIM	MILLIMETERS		
	MIN.	NOM.	MAX.
A	0.80	0.85	0.90
A1	0.00	---	0.02
b	0.25	0.30	0.40
c	0.12	0.15	0.25
D	1.94	2.00	2.06
E	1.54	1.60	1.66
He	2.05	2.10	2.15
L	0.19	0.25	0.31
L1	0.00	0.07	0.12
e	0.65 BSC		

**GENERIC MARKING DIAGRAM\***

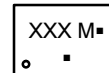

- XXX = Specific Device Code
- M = Date Code
- = Pb-Free Package

(Note: Microdot may be in either location)

\*This information is generic. Please refer to device data sheet for actual part marking. Pb-Free indicator, "G" or microdot "▪", may or may not be present. Some products may not follow the Generic Marking.

<b>DOCUMENT NUMBER:</b>	<b>98AON65646E</b>	Electronic versions are uncontrolled except when accessed directly from the Document Repository. Printed versions are uncontrolled except when stamped "CONTROLLED COPY" in red.
<b>DESCRIPTION:</b>	<b>SC-88FL / MCPH6</b>	<b>PAGE 1 OF 1</b>

onsemi and ONSEMI are trademarks of Semiconductor Components Industries, LLC dba onsemi or its subsidiaries in the United States and/or other countries. onsemi reserves the right to make changes without further notice to any products herein. onsemi makes no warranty, representation or guarantee regarding the suitability of its products for any particular purpose, nor does onsemi assume any liability arising out of the application or use of any product or circuit, and specifically disclaims any and all liability, including without limitation special, consequential or incidental damages. onsemi does not convey any license under its patent rights nor the rights of others.

**onsemi**, **Onsemi**, and other names, marks, and brands are registered and/or common law trademarks of Semiconductor Components Industries, LLC dba "**onsemi**" or its affiliates and/or subsidiaries in the United States and/or other countries. **onsemi** owns the rights to a number of patents, trademarks, copyrights, trade secrets, and other intellectual property. A listing of **onsemi**'s product/patent coverage may be accessed at [www.onsemi.com/site/pdf/Patent-Marking.pdf](http://www.onsemi.com/site/pdf/Patent-Marking.pdf). **onsemi** reserves the right to make changes at any time to any products or information herein, without notice. The information herein is provided "as-is" and **onsemi** makes no warranty, representation or guarantee regarding the accuracy of the information, product features, availability, functionality, or suitability of its products for any particular purpose, nor does **onsemi** assume any liability arising out of the application or use of any product or circuit, and specifically disclaims any and all liability, including without limitation special, consequential or incidental damages. Buyer is responsible for its products and applications using **onsemi** products, including compliance with all laws, regulations and safety requirements or standards, regardless of any support or applications information provided by **onsemi**. "Typical" parameters which may be provided in **onsemi** data sheets and/or specifications can and do vary in different applications and actual performance may vary over time. All operating parameters, including "Typicals" must be validated for each customer application by customer's technical experts. **onsemi** does not convey any license under any of its intellectual property rights nor the rights of others. **onsemi** products are not designed, intended, or authorized for use as a critical component in life support systems or any FDA Class 3 medical devices or medical devices with a same or similar classification in a foreign jurisdiction or any devices intended for implantation in the human body. Should Buyer purchase or use **onsemi** products for any such unintended or unauthorized application, Buyer shall indemnify and hold **onsemi** and its officers, employees, subsidiaries, affiliates, and distributors harmless against all claims, costs, damages, and expenses, and reasonable attorney fees arising out of, directly or indirectly, any claim of personal injury or death associated with such unintended or unauthorized use, even if such claim alleges that **onsemi** was negligent regarding the design or manufacture of the part. **onsemi** is an Equal Opportunity/Affirmative Action Employer. This literature is subject to all applicable copyright laws and is not for resale in any manner.

## ADDITIONAL INFORMATION

### TECHNICAL PUBLICATIONS:

Technical Library: [www.onsemi.com/design/resources/technical-documentation](http://www.onsemi.com/design/resources/technical-documentation)  
onsemi Website: [www.onsemi.com](http://www.onsemi.com)

### ONLINE SUPPORT: [www.onsemi.com/support](http://www.onsemi.com/support)

For additional information, please contact your local Sales Representative at [www.onsemi.com/support/sales](http://www.onsemi.com/support/sales)