

# Si/SiC Hybrid Modules – EliteSiC, 3 Channel Flying Capacitor Boost 1000 V, 100 A IGBT, 1200 V, 30 A SiC Diode, Q2 Package

## NXH300B100H4Q2F2, NXH300B100H4Q2F2SG-R

This high-density, integrated power module combines high-performance IGBTs with 1200 V SiC diode.

### Features

- Extremely Efficient Trench with Field Stop Technology
- Low Switching Loss Reduces System Power Dissipation
- Module Design Offers High Power Density
- Low Inductive Layout
- 3-channel in Q2BOOST Package
- These are Pb-Free Devices

### Typical Applications

- Solar Inverter
- Uninterruptible Power Supplies

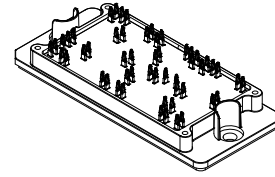

PIM53, 93x47 (PRESSFIT)  
CASE 180CB

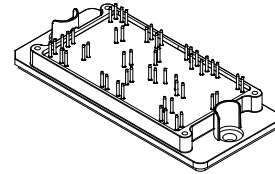

PIM53, 93x47 (SOLDER PIN)  
CASE 180CC

### MARKING DIAGRAM

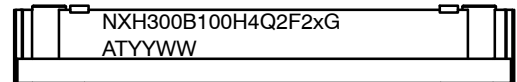

NXH300B100H4Q2F2x = Specific Device Code  
(x = P, S)

AT = Assembly & Test Site Code  
YYWW = Year and Work Week Code

### PIN CONNECTION

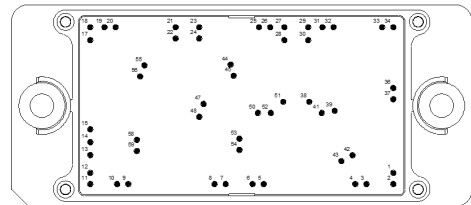

### ORDERING INFORMATION

See detailed ordering and shipping information on page 11 of this data sheet.

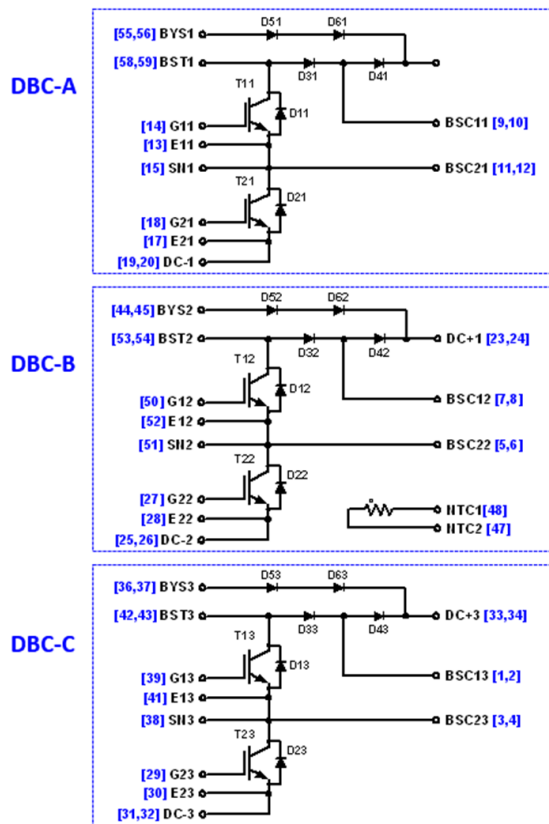

Figure 1. NXH300B100H4Q2F2PG/SG/SG-R Schematic Diagram

# NXH300B100H4Q2F2, NXH300B100H4Q2F2SG-R

## ABSOLUTE MAXIMUM RATINGS (Note 1) ( $T_J = 25^\circ\text{C}$ unless otherwise noted)

Symbol	Parameter	Value	Unit
<b>IGBT (T11, T21, T12, T22, T13, T23)</b>			
$V_{CES}$	Collector-Emitter voltage	1000	V
$V_{GE}$	Gate-Emitter Voltage Positive transient gate-emitter voltage ( $T_{pulse} = 5 \mu\text{s}$ , $D < 0.10$ )	$\pm 20$ 30	V
$I_C$	Continuous Collector Current (@ $V_{GE} = 20 \text{ V}$ , $T_C = 80^\circ\text{C}$ )	73	A
$I_{C(Pulse)}$	Pulsed Peak Collector Current @ $T_C = 80^\circ\text{C}$ ( $T_J = 150^\circ\text{C}$ )	219	A
$P_{tot}$	Power Dissipation ( $T_J = 150^\circ\text{C}$ , $T_C = 80^\circ\text{C}$ )	194	W
$T_{JMIN}$	Minimum Operating Junction Temperature	-40	$^\circ\text{C}$
$T_{JMAX}$	Maximum Operating Junction Temperature	175	$^\circ\text{C}$

## IGBT INVERSE DIODE (D11, D21, D12, D22, D13, D23) AND BYPASS DIODE (D51, D61, D52, D62, D53, D63)

$V_{RRM}$	Peak Repetitive Reverse Voltage	1600	V
$I_F$	Continuous Forward Current @ $T_C = 80^\circ\text{C}$	36	A
$I_{FRM}$	Repetitive Peak Forward Current ( $T_J = 150^\circ\text{C}$ , $T_J$ limited by $T_{Jmax}$ )	108	A
$P_{tot}$	Maximum Power Dissipation @ $T_C = 80^\circ\text{C}$ ( $T_J = 150^\circ\text{C}$ )	79	W
$T_{JMIN}$	Minimum Operating Junction Temperature	-40	$^\circ\text{C}$
$T_{JMAX}$	Maximum Operating Junction Temperature	150	$^\circ\text{C}$

## BOOST SILICON CARBIDE SCHOTTKY DIODE (D31, D41, D32, D42, D33, D43)

$V_{RRM}$	Peak Repetitive Reverse Voltage	1200	V
$I_F$	Continuous Forward Current @ $T_C = 80^\circ\text{C}$	36	A
$I_{FRM}$	Repetitive Peak Forward Current ( $T_J = 150^\circ\text{C}$ , $T_J$ limited by $T_{Jmax}$ )	108	A
$P_{tot}$	Maximum Power Dissipation @ $T_C = 80^\circ\text{C}$ ( $T_J = 150^\circ\text{C}$ )	104	W
$T_{JMIN}$	Minimum Operating Junction Temperature	-40	$^\circ\text{C}$
$T_{JMAX}$	Maximum Operating Junction Temperature	175	$^\circ\text{C}$

Stresses exceeding those listed in the Maximum Ratings table may damage the device. If any of these limits are exceeded, device functionality should not be assumed, damage may occur and reliability may be affected.

1. Refer to ELECTRICAL CHARACTERISTICS, RECOMMENDED OPERATING RANGES and/or APPLICATION INFORMATION for Safe Operating parameters.

## THERMAL AND INSULATION PROPERTIES (Note 1) ( $T_J = 25^\circ\text{C}$ unless otherwise noted)

Symbol	Rating	Value	Unit
<b>THERMAL PROPERTIES</b>			
$T_{VJOP}$	Operating Temperature under Switching Condition	-40 to 150	$^\circ\text{C}$
$T_{stg}$	Storage Temperature Range	-40 to 125	$^\circ\text{C}$

## INSULATION PROPERTIES

$V_{is}$	Isolation Test Voltage, $t = 2 \text{ sec}$ , 50 Hz (Note 3)	4000	$V_{RMS}$
	Creepage Distance	12.7	mm
CTI	Comparative Tracking Index	>600	

Stresses exceeding those listed in the Maximum Ratings table may damage the device. If any of these limits are exceeded, device functionality should not be assumed, damage may occur and reliability may be affected.

2. Refer to ELECTRICAL CHARACTERISTICS, RECOMMENDED OPERATING RANGES and/or APPLICATION INFORMATION for Safe Operating parameters.
3. 4000  $V_{ACRMS}$  for 1 second duration is equivalent to 3333  $V_{ACRMS}$  for 1 minute duration.

# NXH300B100H4Q2F2, NXH300B100H4Q2F2SG-R

## ELECTRICAL CHARACTERISTICS (T<sub>J</sub> = 25°C unless otherwise noted)

Symbol	Parameter	Test Condition	Min	Typ	Max	Unit
<b>IGBT (T11, T21, T12, T22, T13, T23)</b>						
V <sub>(BR)CES</sub>	Collector-Emitter Breakdown Voltage	V <sub>GE</sub> = 0 V, I <sub>C</sub> = 1 mA	1000	1118	–	V
V <sub>CE(SAT)</sub>	Collector-Emitter Saturation Voltage	V <sub>GE</sub> = 15 V, I <sub>C</sub> = 100 A, T <sub>C</sub> = 25°C	–	1.80	2.25	V
		V <sub>GE</sub> = 15 V, I <sub>C</sub> = 100 A, T <sub>C</sub> = 150°C	–	2.03	–	
V <sub>GE(TH)</sub>	Gate-Emitter Threshold Voltage	V <sub>GE</sub> = V <sub>CE</sub> , I <sub>C</sub> = 100 mA	4.1	5.08	5.9	V
I <sub>CES</sub>	Collector-Emitter Cutoff Current	V <sub>GE</sub> = 0 V, V <sub>CE</sub> = 1000 V	–	–	800	μA
I <sub>GES</sub>	Gate Leakage Current	V <sub>GE</sub> = ±20 V, V <sub>CE</sub> = 0 V	–	–	±400	nA
r <sub>g</sub>	Internal Gate Resistor		–	5	–	Ω
t <sub>d(on)</sub>	Turn-On Delay Time	T <sub>J</sub> = 25°C V <sub>CE</sub> = 600 V, I <sub>C</sub> = 50 A V <sub>GE</sub> = -9 V, +15 V, R <sub>G</sub> = 6 Ω	–	95	–	ns
t <sub>r</sub>	Rise Time		–	15.42	–	
t <sub>d(off)</sub>	Turn-Off Delay Time		–	267	–	
t <sub>f</sub>	Fall time		–	59	–	
E <sub>on</sub>	Turn on switching loss		–	1030	–	
E <sub>off</sub>	Turn off switching loss	–	1200	–	μJ	
t <sub>d(on)</sub>	Turn-On Delay Time	T <sub>J</sub> = 125°C V <sub>CE</sub> = 600 V, I <sub>C</sub> = 50 A V <sub>GE</sub> = -9 V, +15 V, R <sub>G</sub> = 6 Ω	–	97	–	ns
t <sub>r</sub>	Rise Time		–	18	–	
t <sub>d(off)</sub>	Turn-Off Delay Time		–	314	–	
t <sub>f</sub>	Fall time		–	93	–	
E <sub>on</sub>	Turn on switching loss		–	1260	–	
E <sub>off</sub>	Turn off switching loss	–	2140	–	μJ	
C <sub>ies</sub>	Input capacitance	V <sub>CE</sub> = 20 V, V <sub>GE</sub> = 0 V, f = 1 MHz	–	6323	–	pF
C <sub>oes</sub>	Output capacitance		–	241	–	
C <sub>res</sub>	Reverse transfer capacitance		–	34	–	
Q <sub>g</sub>	Gate Charge	V <sub>CE</sub> = 600 V, V <sub>GE</sub> = -15/+15 V, I <sub>C</sub> = 75 A	–	340	–	nC
R <sub>thJH</sub>	Thermal Resistance – chip-to-heatsink	Thermal grease, Thickness = 2.1 Mil ±2% λ = 2.9 W/mK	–	0.66	–	K/W
R <sub>thJC</sub>	Thermal Resistance – chip-to-case		–	0.48	–	K/W

## IGBT INVERSE DIODE (D11, D21, D12, D22, D13, D23) AND BYPASS DIODE (D51, D61, D52, D62, D53, D63)

V <sub>F</sub>	Diode Forward Voltage	I <sub>F</sub> = 30 A, T <sub>J</sub> = 25°C	–	1.04	1.7	V
		I <sub>F</sub> = 30 A, T <sub>J</sub> = 150°C	–	0.94	–	
R <sub>thJH</sub>	Thermal Resistance – chip-to-heatsink	Thermal grease, Thickness = 2.1 Mil ±2% λ = 2.9 W/mK	–	1.04	–	K/W

## BOOST SILICON CARBIDE SCHOTTKY DIODE (D31, D41, D32, D42, D33, D43)

I <sub>R</sub>	Diode Reverse Leakage Current	V <sub>R</sub> = 1200 V, T <sub>J</sub> = 25°C	–	–	600	μA
V <sub>F</sub>	Diode Forward Voltage	I <sub>F</sub> = 30 A, T <sub>J</sub> = 25°C	–	1.42	1.7	V
		I <sub>F</sub> = 30 A, T <sub>J</sub> = 150°C	–	1.85	–	
t <sub>rr</sub>	Reverse Recovery Time	T <sub>J</sub> = 25°C V <sub>DS</sub> = 600 V, I <sub>C</sub> = 50 A V <sub>GE</sub> = -9 V, 15 V, R <sub>G</sub> = 1 Ω	–	15	–	ns
Q <sub>rr</sub>	Reverse Recovery Charge		–	128	–	nC
I <sub>RRM</sub>	Peak Reverse Recovery Current		–	13	–	A
di/dt	Peak Rate of Fall of Recovery Current		–	4200	–	A/μs
E <sub>rr</sub>	Reverse Recovery Energy		–	16	–	μJ

## NXH300B100H4Q2F2, NXH300B100H4Q2F2SG-R

### ELECTRICAL CHARACTERISTICS ( $T_J = 25^\circ\text{C}$ unless otherwise noted) (continued)

Symbol	Parameter	Test Condition	Min	Typ	Max	Unit
<b>BOOST SILICON CARBIDE SCHOTTKY DIODE (D31, D41, D32, D42, D33, D43)</b>						
$t_{rr}$	Reverse Recovery Time	$T_J = 125^\circ\text{C}$ $V_{DS} = 600\text{ V}$ , $I_C = 50\text{ A}$ $V_{GE} = -9\text{ V}$ , $15\text{ V}$ , $R_G = 1\ \Omega$	-	19	-	ns
$Q_{rr}$	Reverse Recovery Charge		-	175	-	nC
$I_{RRM}$	Peak Reverse Recovery Current		-	17	-	A
$di/dt$	Peak Rate of Fall of Recovery Current		-	3153	-	A/ $\mu\text{s}$
$E_{rr}$	Reverse Recovery Energy		-	18	-	$\mu\text{J}$
$R_{thJH}$	Thermal Resistance - chip-to-heatsink	Thermal grease, Thickness = 2.1 Mil $\pm 2\%$ $\lambda = 2.9\text{ W/mK}$	-	0.85	-	K/W
$R_{thJC}$	Thermal Resistance - chip-to-case		-	0.73	-	K/W

### THERMISTOR CHARACTERISTICS

$R_{25}$	Nominal resistance		-	22	-	k $\Omega$
$R_{100}$	Nominal resistance	$T = 100^\circ\text{C}$	-	1486	-	$\Omega$
$\Delta R/R$	Deviation of $R_{25}$		-5	-	5	%
$P_D$	Power dissipation		-	200	-	mW
	Power dissipation constant		-	2	-	mW/K
	B-value	B (25/50), tolerance $\pm 3\%$	-	3950	-	K
	B-value	B (25/100), tolerance $\pm 3\%$	-	3998	-	K

Product parametric performance is indicated in the Electrical Characteristics for the listed test conditions, unless otherwise noted. Product performance may not be indicated by the Electrical Characteristics if operated under different conditions.

# NXH300B100H4Q2F2, NXH300B100H4Q2F2SG-R

## TYPICAL CHARACTERISTICS – IGBT, INVERSE & BYPASS DIODE AND BOOST DIODE

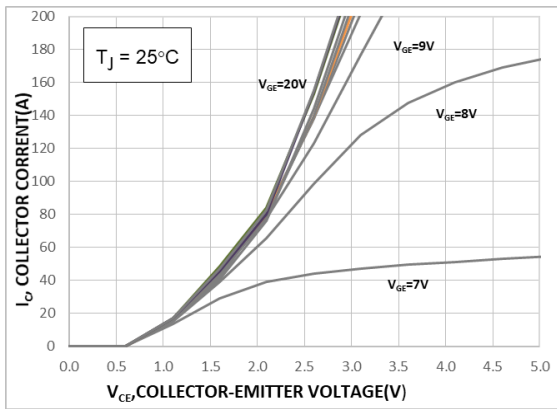

Figure 2. Typical Output Characteristics

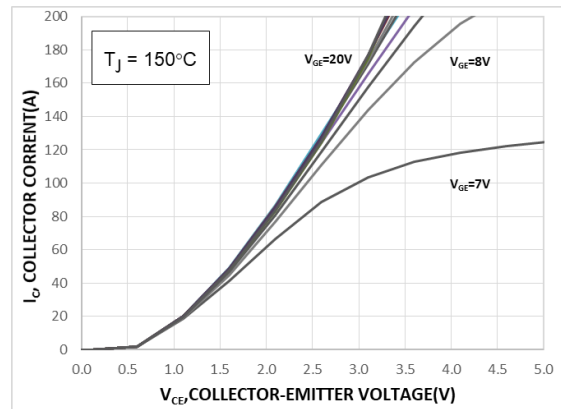

Figure 3. Typical Output Characteristics

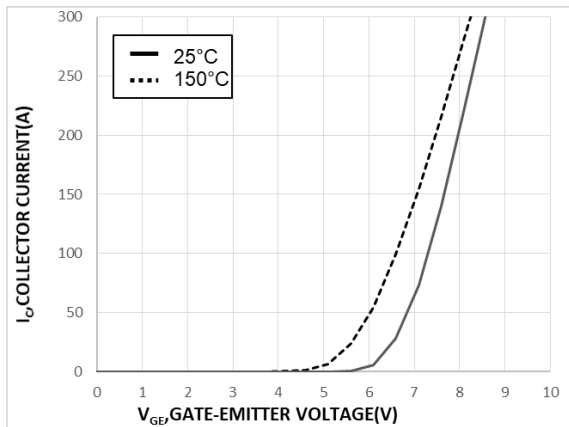

Figure 4. Transfer Characteristics

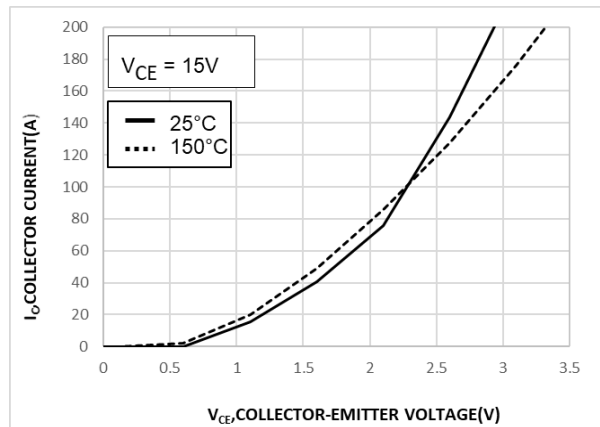

Figure 5. Typical Saturation Voltage Characteristics

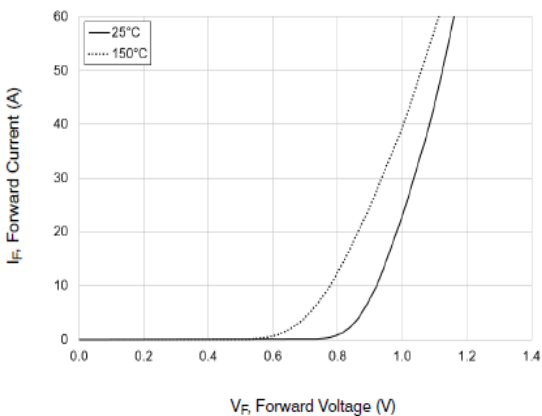

Figure 6. Inverse Diode Forward Characteristics

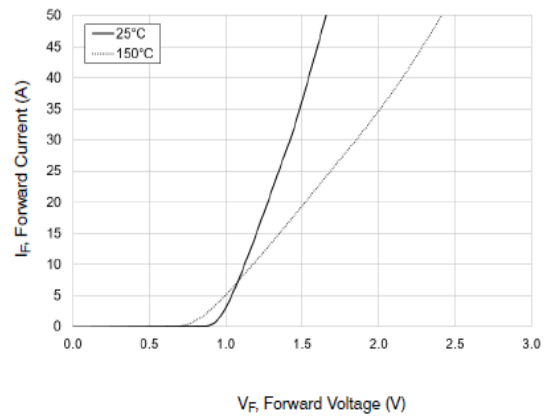

Figure 7. Boost Diode Forward Characteristics

TYPICAL CHARACTERISTICS – IGBT, INVERSE & BYPASS DIODE AND BOOST DIODE (CONTINUED)

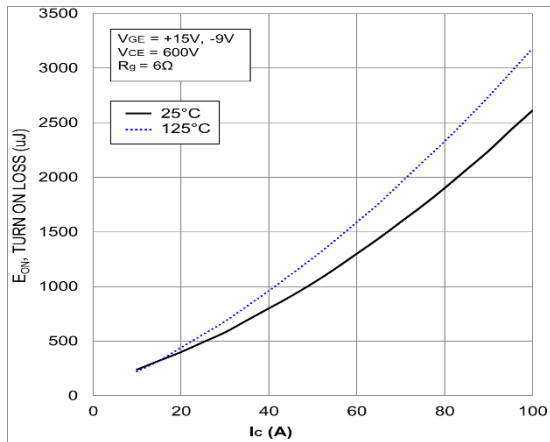

Figure 8. Typical Turn On Loss vs.  $I_c$

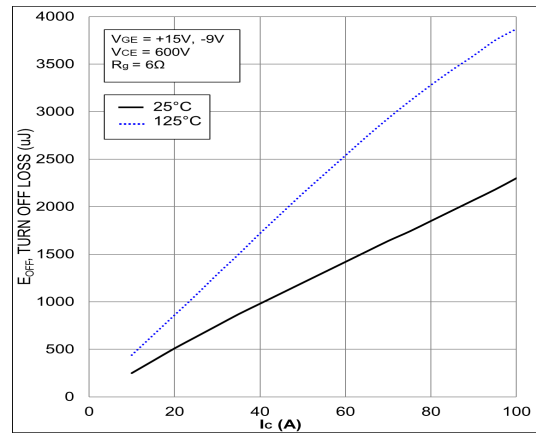

Figure 9. Typical Turn Off Loss vs.  $I_c$

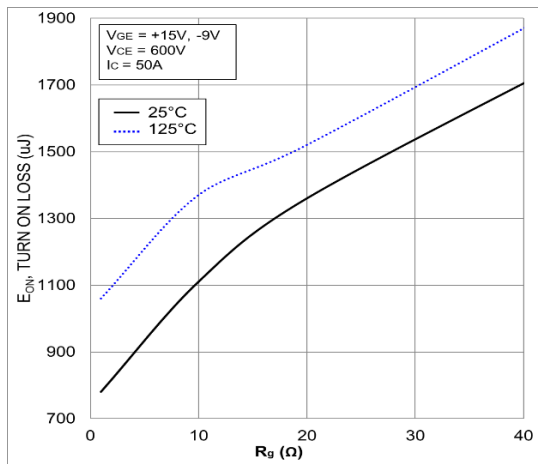

Figure 10. Typical Turn On Loss vs.  $R_g$

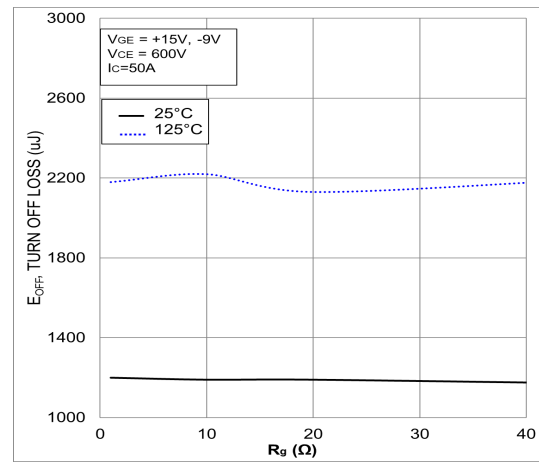

Figure 11. Typical Turn Off Loss vs.  $R_g$

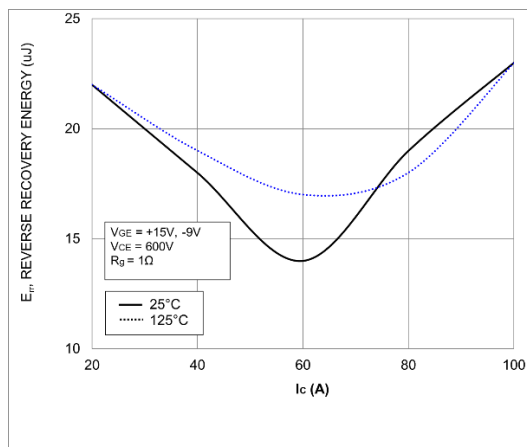

Figure 12. Typical Reverse Recovery Energy Loss vs.  $I_c$

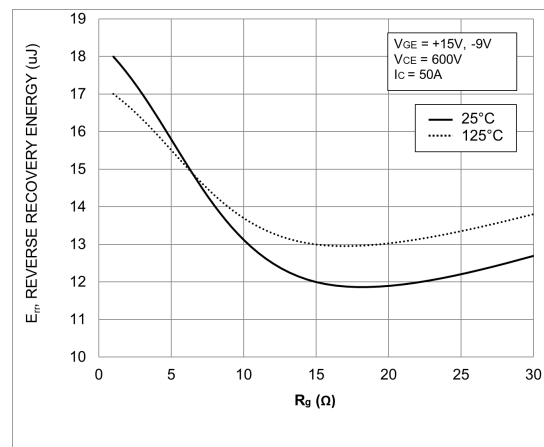

Figure 13. Typical Reverse Recovery Energy Loss vs.  $R_g$

# NXH300B100H4Q2F2, NXH300B100H4Q2F2SG-R

## TYPICAL CHARACTERISTICS – IGBT, INVERSE & BYPASS DIODE AND BOOST DIODE (CONTINUED)

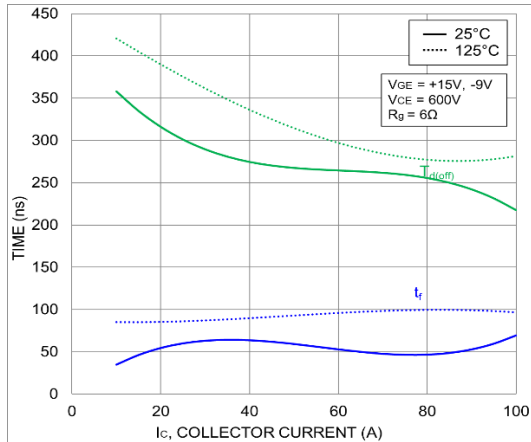

Figure 14. Typical Turn-Off Switching Time vs.  $I_c$

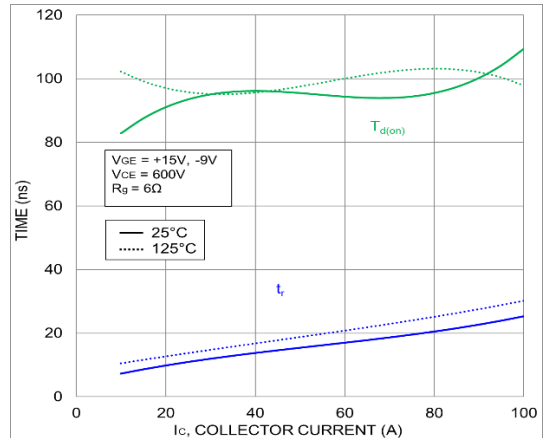

Figure 15. Typical Turn-On Switching Time vs.  $I_c$

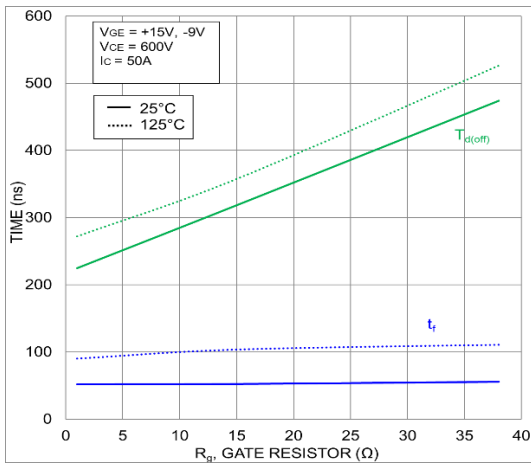

Figure 16. Typical Turn-Off Switching Time vs.  $R_g$

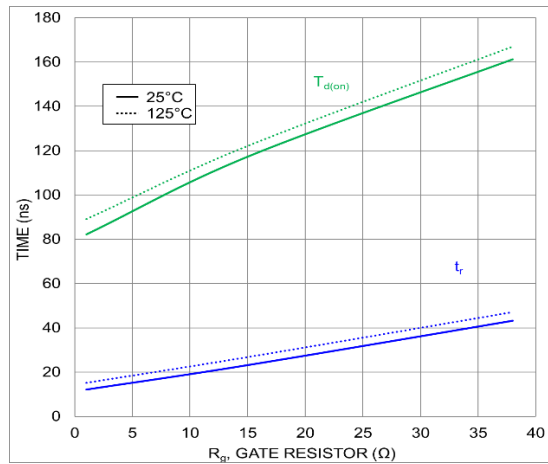

Figure 17. Typical Turn-On Switching Time vs.  $R_g$

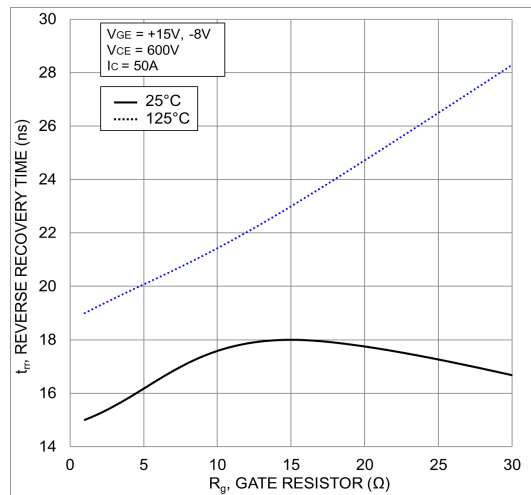

Figure 18. Typical Reverse Recovery Time vs.  $R_g$

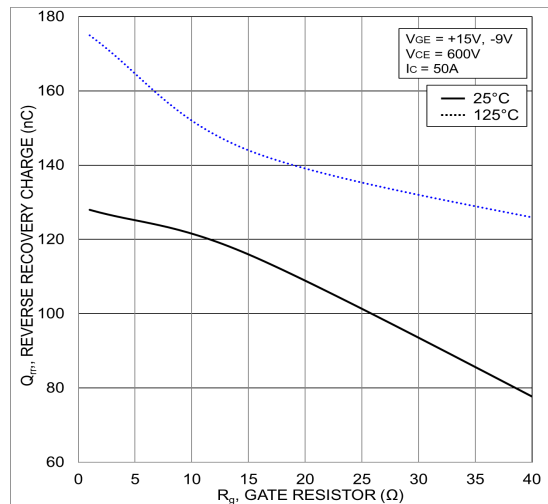
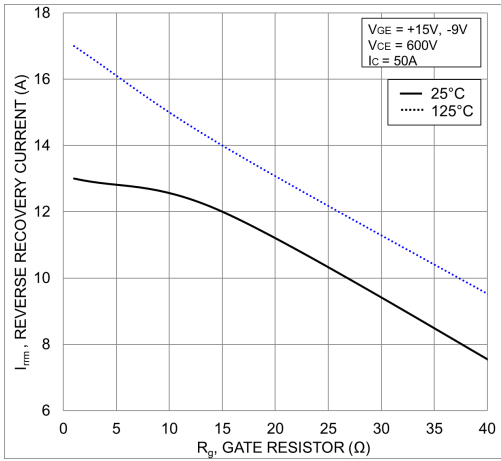

Figure 19. Typical Reverse Recovery Charge vs.  $R_g$

# NXH300B100H4Q2F2, NXH300B100H4Q2F2SG-R

## TYPICAL CHARACTERISTICS – IGBT, INVERSE & BYPASS DIODE AND BOOST DIODE (CONTINUED)



**Figure 20. Typical Reverse Recovery Peak Current vs.  $R_g$**

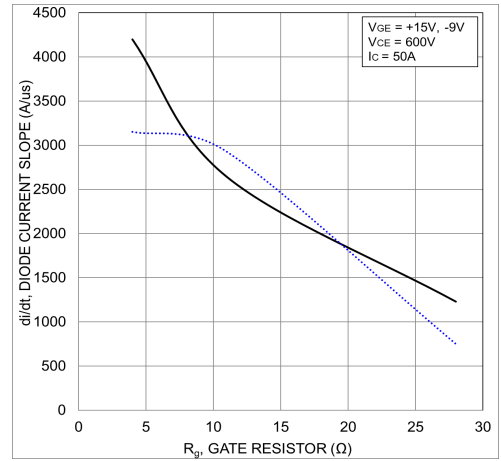

**Figure 21. Typical  $di/dt$  vs.  $R_g$**

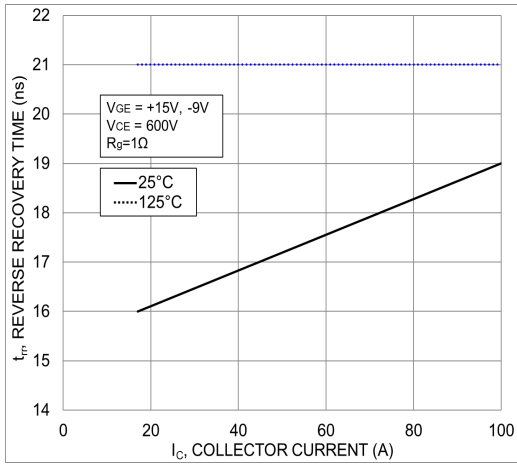

**Figure 22. Typical Reverse Recovery Time vs.  $I_C$**

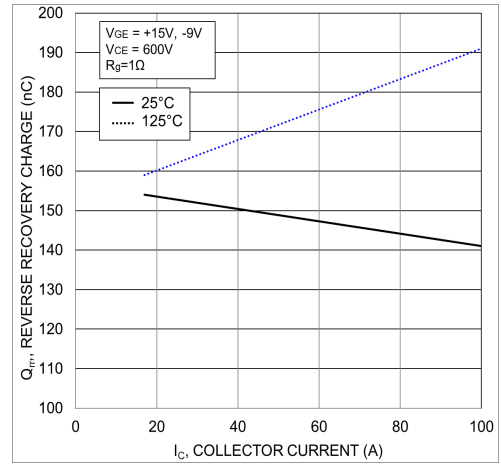

**Figure 23. Typical Reverse Recovery Charge vs.  $I_C$**

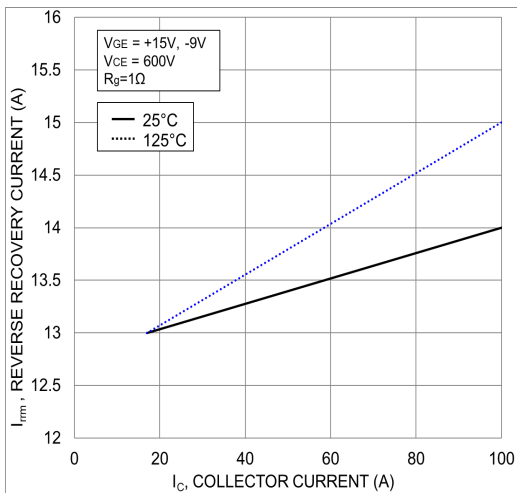

**Figure 24. Typical Reverse Recovery Current vs.  $I_C$**

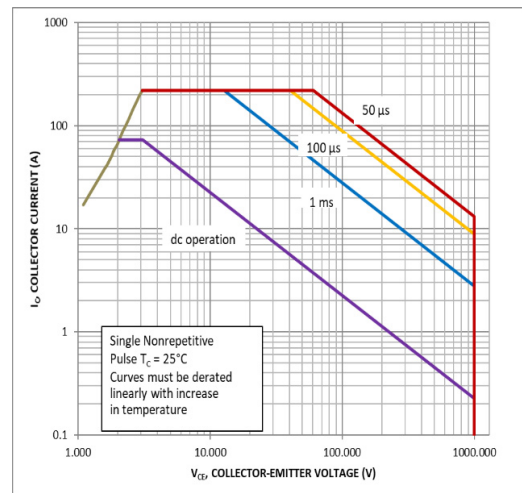
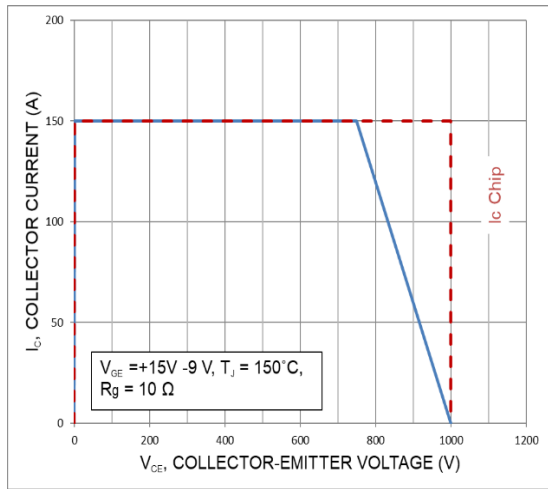

**Figure 25. FBSOA**



# NXH300B100H4Q2F2, NXH300B100H4Q2F2SG-R

## TYPICAL CHARACTERISTICS – IGBT, INVERSE & BYPASS DIODE AND BOOST DIODE (CONTINUED)



**Figure 26. RBSOA**

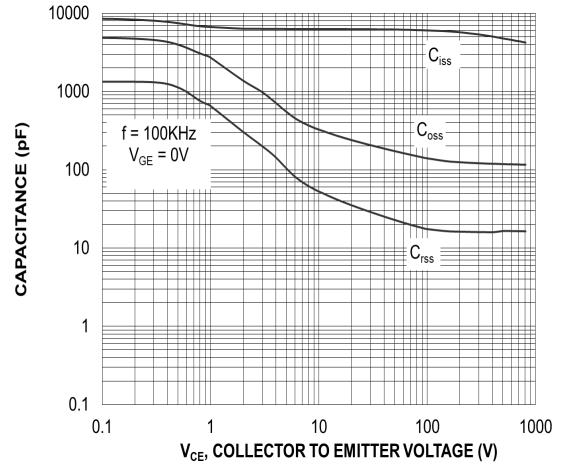

**Figure 27. Capacitance Charge**

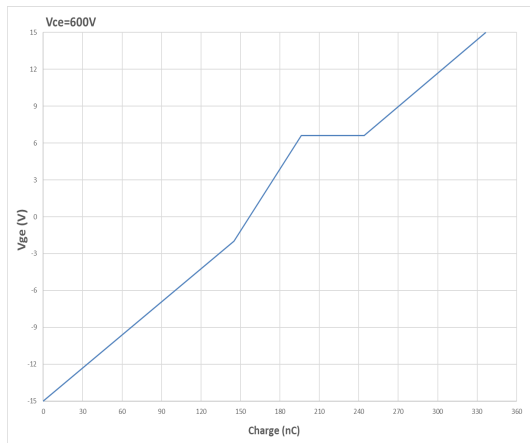

**Figure 28. Gate Voltage vs. Gate Charge**

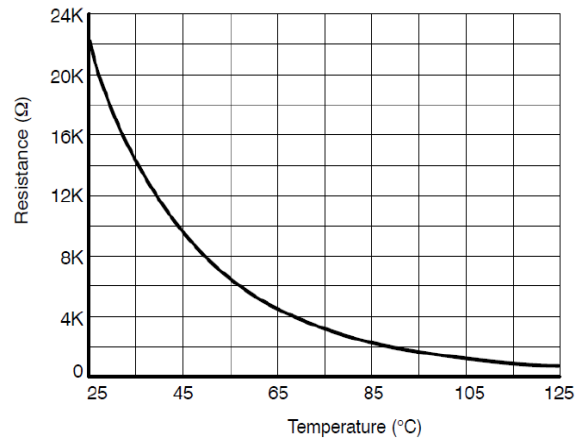

**Figure 29. NTC Characteristics**

TYPICAL CHARACTERISTICS – IGBT, INVERSE & BYPASS DIODE AND BOOST DIODE (CONTINUED)

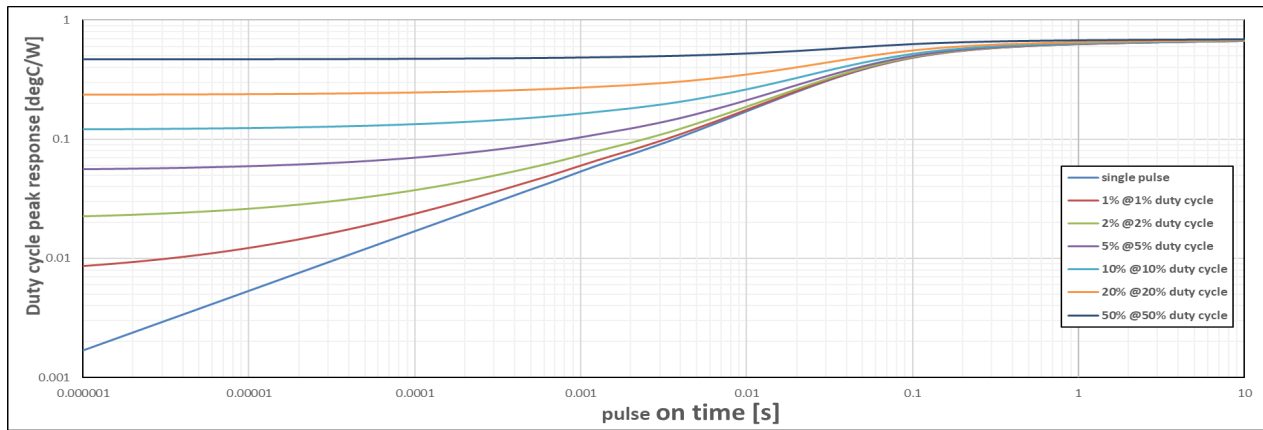

Figure 30. Transient Thermal Impedance (IGBT)

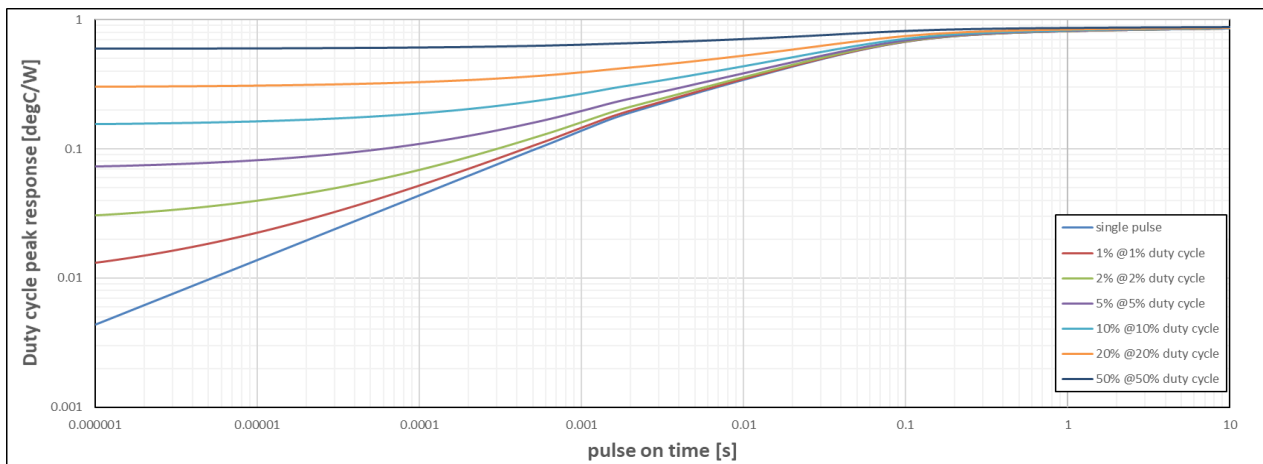

Figure 31. Transient Thermal Impedance (BOOST DIODE)

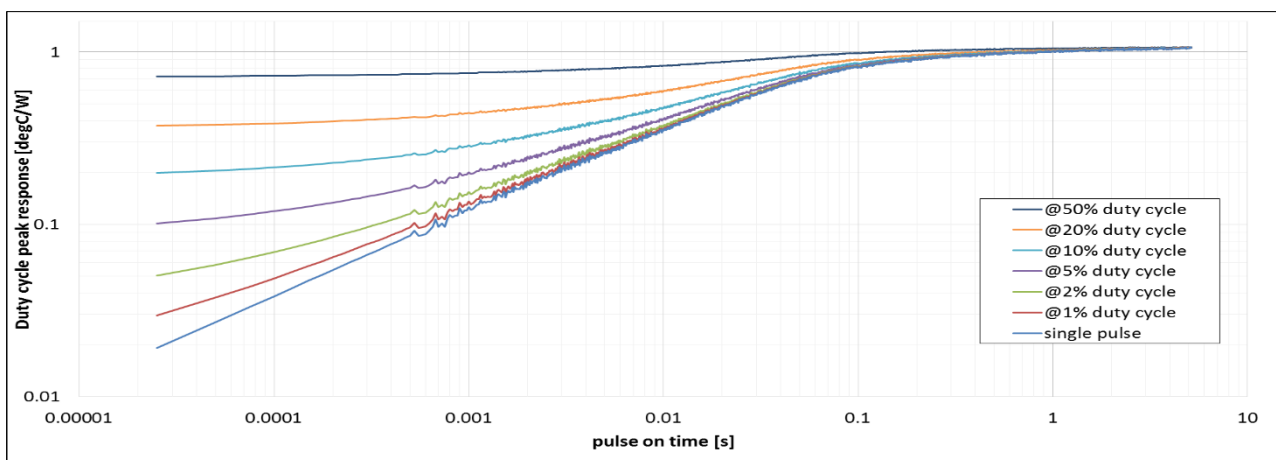

Figure 32. Transient Thermal Impedance (INVERSE&BYPASS DIODE)

# NXH300B100H4Q2F2, NXH300B100H4Q2F2SG-R

## ORDERING INFORMATION

Orderable Part Number	Marking	Package	Shipping
NXH300B100H4Q2F2PG PRESS FIT PINS	NXH300B100H4Q2F2PG	Q2BOOST - PIM53, 93x47 (PRESSFIT) (Pb-Free and Halide-Free Press Fit Pins)	12 Units / Blister Tray
NXH300B100H4Q2F2SG, NXH300B100H4Q2F2SG-R SOLDER PINS	NXH300B100H4Q2F2SG, NXH300B100H4Q2F2SG-R	Q2BOOST - PIM53, 93x47 (SOLDER PIN) (Pb-Free and Halide-Free Solder Pins)	12 Units / Blister Tray

# MECHANICAL CASE OUTLINE

## PACKAGE DIMENSIONS

ON Semiconductor®



### PIM53, 93x47 (PRESSFIT) CASE 180CB ISSUE O

DATE 30 APR 2020

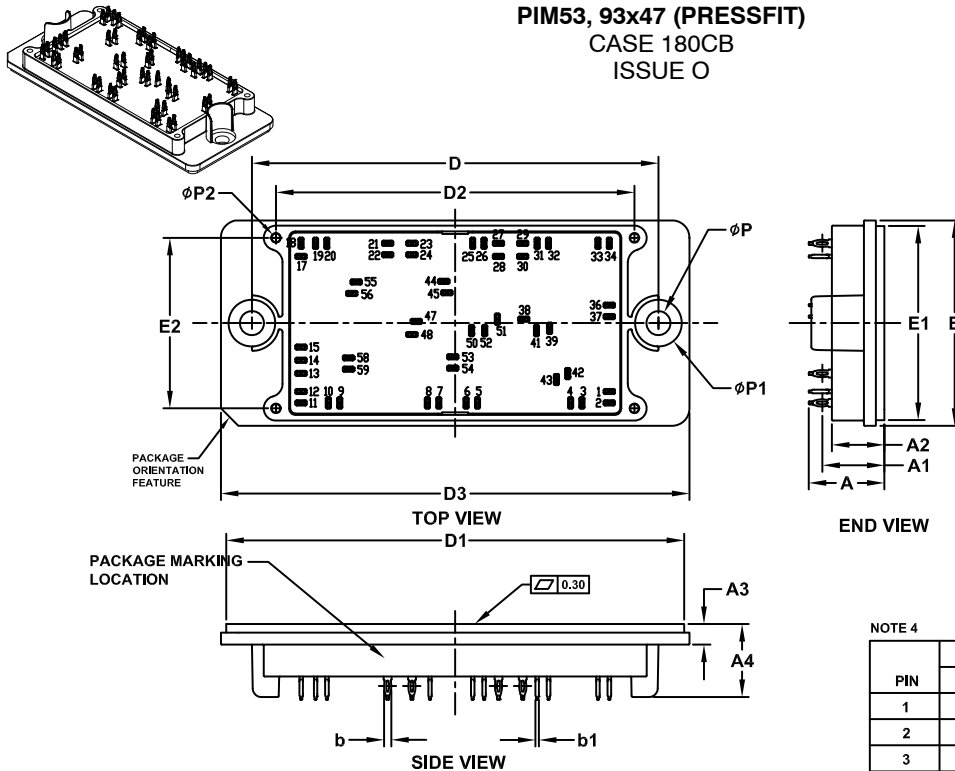

DIM	MILLIMETERS		
	MIN.	NOM.	MAX.
A	16.90	17.30	17.70
A1	13.97	14.18	14.39
A2	11.70	12.00	12.30
A3	4.40	4.70	5.00
A4	16.40	16.70	17.00
b	1.61	1.66	1.71
b1	0.75	0.80	0.85
D	92.90	93.00	93.10
D1	104.45	104.75	105.05
D2	81.80	82.00	82.20
D3	106.90	107.20	107.50
E	46.70	47.00	47.30
E1	44.10	44.40	44.70
E2	38.80	39.00	39.20
P	5.40	5.50	5.60
P1	10.60	10.70	10.80
P2	1.80	2.00	2.20

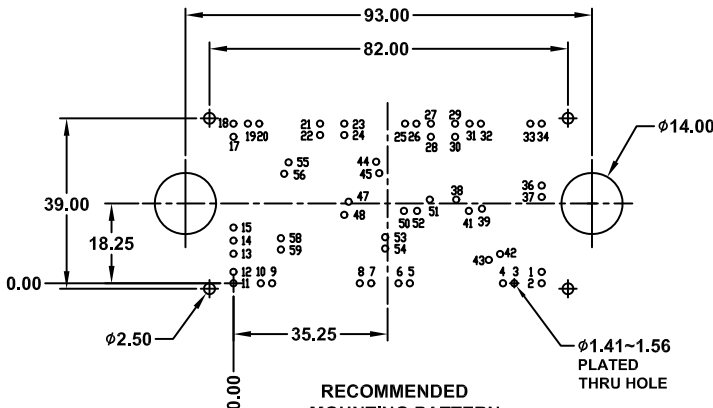

NOTES:

1. DIMENSIONING AND TOLERANCING PER ASME Y14.5M, 2009
2. CONTROLLING DIMENSION : MILLIMETERS
3. DIMENSIONS b AND b1 APPLY TO THE PLATED TERMINALS AND ARE MEASURED AT DIMENSION A1
4. PIN POSITION TOLERANCE IS ± 0.4mm
5. PACKAGE MARKING IS LOCATED AS SHOWN ON THE SIDE OPPOSITE THE PACKAGE ORIENTATION FEATURES

### GENERIC MARKING DIAGRAM\*

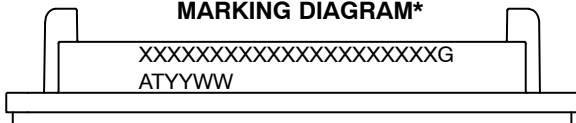

XXXXX = Specific Device Code  
 G = Pb-Free Package  
 AT = Assembly & Test Site Code  
 YYWW= Year and Work Week Code

\*This information is generic. Please refer to device data sheet for actual part marking. Pb-Free indicator, "G" or microdot "▪", may or may not be present. Some products may not follow the Generic Marking.

NOTE 4

PIN	PIN POSITION		PIN	PIN POSITION	
	X	Y		X	Y
1	70.50	2.60	29	50.70	36.50
2	70.50	0.00	30	50.70	33.50
3	64.25	0.00	31	54.00	36.50
4	61.65	0.00	32	56.60	36.50
5	40.35	0.00	33	67.90	36.50
6	37.75	0.00	34	70.50	36.50
7	31.50	0.00	36	70.50	22.35
8	28.90	0.00	37	70.50	19.75
9	8.85	0.00	38	50.95	19.15
10	6.25	0.00	39	56.85	17.05
11	0.00	0.00	41	53.85	16.55
12	0.00	2.60	42	61.00	6.70
13	0.00	6.75	43	58.40	5.35
14	0.00	9.75	44	32.65	27.80
15	0.00	12.75	45	33.35	25.20
17	0.00	33.50	47	26.35	18.65
18	0.00	36.50	48	25.35	15.65
19	3.30	36.50	50	39.00	16.55
20	5.90	36.50	51	44.90	19.15
21	19.80	36.50	52	42.00	16.55
22	19.80	33.90	53	34.70	10.55
23	25.35	36.50	54	34.70	7.95
24	25.35	33.90	55	12.60	27.65
25	39.25	36.50	56	11.60	25.05
26	41.85	36.50	58	10.85	10.30
27	45.15	36.50	59	10.85	7.70
28	45.15	33.50			

DOCUMENT NUMBER:	98AON20720H	Electronic versions are uncontrolled except when accessed directly from the Document Repository. Printed versions are uncontrolled except when stamped "CONTROLLED COPY" in red.
DESCRIPTION:	PIM53 93X47 (PRESS FIT)	PAGE 1 OF 1

ON Semiconductor and ON are trademarks of Semiconductor Components Industries, LLC dba ON Semiconductor or its subsidiaries in the United States and/or other countries. ON Semiconductor reserves the right to make changes without further notice to any products herein. ON Semiconductor makes no warranty, representation or guarantee regarding the suitability of its products for any particular purpose, nor does ON Semiconductor assume any liability arising out of the application or use of any product or circuit, and specifically disclaims any and all liability, including without limitation special, consequential or incidental damages. ON Semiconductor does not convey any license under its patent rights nor the rights of others.

# MECHANICAL CASE OUTLINE

## PACKAGE DIMENSIONS

ON Semiconductor®



### PIM53, 93x47 (SOLDER PIN) CASE 180CC ISSUE O

DATE 04 MAY 2020

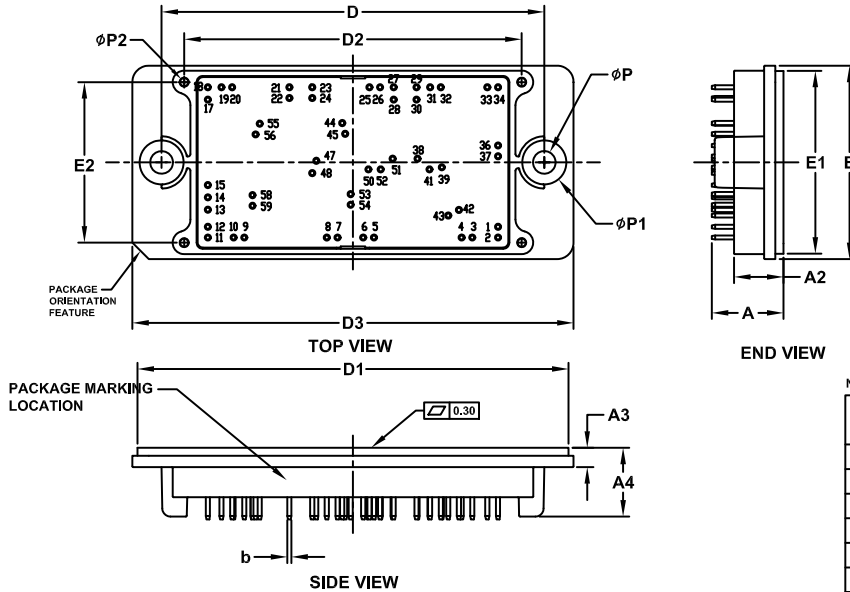
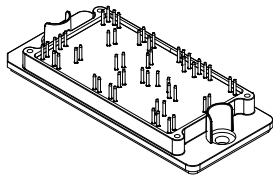

DIM	MILLIMETERS		
	MIN.	NOM.	MAX.
A	16.80	17.20	17.60
A2	11.70	12.00	12.30
A3	4.40	4.70	5.00
A4	16.40	16.70	17.00
b	0.95	1.00	1.05
D	92.90	93.00	93.10
D1	104.45	104.75	105.05
D2	81.80	82.00	82.20
D3	106.90	107.20	107.50
E	46.70	47.00	47.30
E1	44.10	44.40	44.70
E2	38.80	39.00	39.20
P	5.40	5.50	5.60
P1	10.60	10.70	10.80
P2	1.80	2.00	2.20

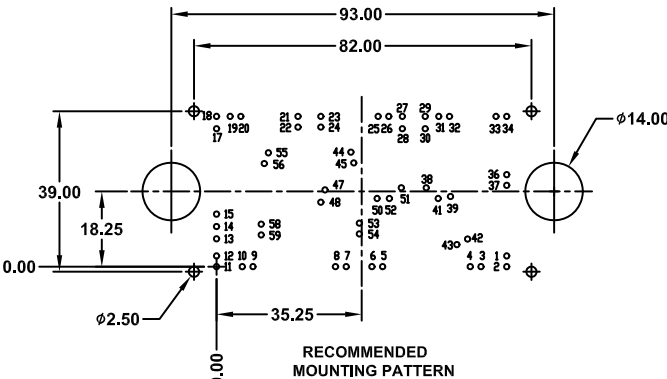

**RECOMMENDED MOUNTING PATTERN**  
\* For additional information on our Pb-Free strategy and soldering details, please download the ON Semiconductor Soldering and Mounting Techniques Reference Manual, SOLDERRM/D.

**NOTES:**

1. DIMENSIONING AND TOLERANCING PER ASME Y14.5M, 2009
2. CONTROLLING DIMENSION : MILLIMETERS
3. DIMENSIONS b AND b1 APPLY TO THE PLATED TERMINALS AND ARE MEASURED AT DIMENSION A1
4. PIN POSITION TOLERANCE IS ± 0.4mm
5. PACKAGE MARKING IS LOCATED AS SHOWN ON THE SIDE OPPOSITE THE PACKAGE ORIENTATION FEATURES

**GENERIC MARKING DIAGRAM\***

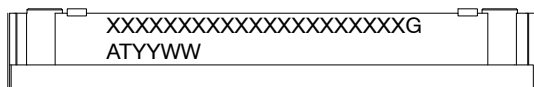

XXXXX = Specific Device Code  
G = Pb-Free Package  
AT = Assembly & Test Site Code  
YYWW = Year and Work Week Code

\*This information is generic. Please refer to device data sheet for actual part marking. Pb-Free indicator, "G" or microdot "▪", may or may not be present. Some products may not follow the Generic Marking.

**NOTE 4**

PIN	PIN POSITION		PIN	PIN POSITION	
	X	Y		X	Y
1	70.50	2.60	29	50.70	36.50
2	70.50	0.00	30	50.70	33.50
3	64.25	0.00	31	54.00	36.50
4	61.65	0.00	32	56.60	36.50
5	40.35	0.00	33	67.90	36.50
6	37.75	0.00	34	70.50	36.50
7	31.50	0.00	36	70.50	22.35
8	28.90	0.00	37	70.50	19.75
9	8.85	0.00	38	50.95	19.15
10	6.25	0.00	39	56.85	17.05
11	0.00	0.00	41	53.85	16.55
12	0.00	2.60	42	61.00	6.70
13	0.00	6.75	43	58.40	5.35
14	0.00	9.75	44	32.65	27.80
15	0.00	12.75	45	33.35	25.20
17	0.00	33.50	47	26.35	18.65
18	0.00	36.50	48	25.35	15.65
19	3.30	36.50	50	39.00	16.55
20	5.90	36.50	51	44.90	19.15
21	19.80	36.50	52	42.00	16.55
22	19.80	33.90	53	34.70	10.55
23	25.35	36.50	54	34.70	7.95
24	25.35	33.90	55	12.60	27.65
25	39.25	36.50	56	11.60	25.05
26	41.85	36.50	58	10.85	10.30
27	45.15	36.50	59	10.85	7.70
28	45.15	33.50			

<b>DOCUMENT NUMBER:</b>	<b>98AON20721H</b>	Electronic versions are uncontrolled except when accessed directly from the Document Repository. Printed versions are uncontrolled except when stamped "CONTROLLED COPY" in red.
<b>DESCRIPTION:</b>	<b>PIM53 93X47 (SOLDER PIN)</b>	<b>PAGE 1 OF 1</b>

ON Semiconductor and ON are trademarks of Semiconductor Components Industries, LLC dba ON Semiconductor or its subsidiaries in the United States and/or other countries. ON Semiconductor reserves the right to make changes without further notice to any products herein. ON Semiconductor makes no warranty, representation or guarantee regarding the suitability of its products for any particular purpose, nor does ON Semiconductor assume any liability arising out of the application or use of any product or circuit, and specifically disclaims any and all liability, including without limitation special, consequential or incidental damages. ON Semiconductor does not convey any license under its patent rights nor the rights of others.

**onsemi**, **Onsemi**, and other names, marks, and brands are registered and/or common law trademarks of Semiconductor Components Industries, LLC dba "**onsemi**" or its affiliates and/or subsidiaries in the United States and/or other countries. **onsemi** owns the rights to a number of patents, trademarks, copyrights, trade secrets, and other intellectual property. A listing of **onsemi**'s product/patent coverage may be accessed at [www.onsemi.com/site/pdf/Patent-Marking.pdf](http://www.onsemi.com/site/pdf/Patent-Marking.pdf). **onsemi** reserves the right to make changes at any time to any products or information herein, without notice. The information herein is provided "as-is" and **onsemi** makes no warranty, representation or guarantee regarding the accuracy of the information, product features, availability, functionality, or suitability of its products for any particular purpose, nor does **onsemi** assume any liability arising out of the application or use of any product or circuit, and specifically disclaims any and all liability, including without limitation special, consequential or incidental damages. Buyer is responsible for its products and applications using **onsemi** products, including compliance with all laws, regulations and safety requirements or standards, regardless of any support or applications information provided by **onsemi**. "Typical" parameters which may be provided in **onsemi** data sheets and/or specifications can and do vary in different applications and actual performance may vary over time. All operating parameters, including "Typicals" must be validated for each customer application by customer's technical experts. **onsemi** does not convey any license under any of its intellectual property rights nor the rights of others. **onsemi** products are not designed, intended, or authorized for use as a critical component in life support systems or any FDA Class 3 medical devices or medical devices with a same or similar classification in a foreign jurisdiction or any devices intended for implantation in the human body. Should Buyer purchase or use **onsemi** products for any such unintended or unauthorized application, Buyer shall indemnify and hold **onsemi** and its officers, employees, subsidiaries, affiliates, and distributors harmless against all claims, costs, damages, and expenses, and reasonable attorney fees arising out of, directly or indirectly, any claim of personal injury or death associated with such unintended or unauthorized use, even if such claim alleges that **onsemi** was negligent regarding the design or manufacture of the part. **onsemi** is an Equal Opportunity/Affirmative Action Employer. This literature is subject to all applicable copyright laws and is not for resale in any manner.

## ADDITIONAL INFORMATION

### TECHNICAL PUBLICATIONS:

Technical Library: [www.onsemi.com/design/resources/technical-documentation](http://www.onsemi.com/design/resources/technical-documentation)  
onsemi Website: [www.onsemi.com](http://www.onsemi.com)

### ONLINE SUPPORT: [www.onsemi.com/support](http://www.onsemi.com/support)

For additional information, please contact your local Sales Representative at [www.onsemi.com/support/sales](http://www.onsemi.com/support/sales)