

Automotive 750 V, 600 A Dual Side Cooling Half-Bridge Power Module

VE-Trac™ Dual NVG600A75L4DSE2

Product Description

The NVG600A75L4DSE2 is part of VE-Trac™ Dual family of power modules with dual side cooling and compact footprints for Hybrid (HEV) and Electric Vehicle (EV) traction inverter application.

The module consists of two narrow mesa Field Stop (FS4) IGBTs in a half-bridge configuration. The chipset utilizes the new narrow mesa IGBT technology in providing high current density and robust short circuit protection with higher blocking voltage to deliver outstanding performance in EV traction applications.

Liquid cooling heatsink reference design, loss models and CAD models are available to support customers in inverter designs.

Features

- Dual-Side Cooling
- Integrated Chip Level Temperature and Current Sensor
- $T_{vj\ max} = 175^{\circ}C$ for Continuous Operation
- Low-Stray Inductance
- Low Conduction and Switching Losses
- Automotive Grade
- 4.2 kV Isolated DBC Substrate
- AEC Qualified and PPAP Capable
- This Device is Pb-Free and is RoHS Compliant

Typical Applications

- Hybrid and Electric Vehicle Traction Inverter
- High Power DC-DC Boost Converter

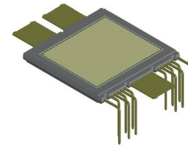

AHPM15-CFA MODULE
 CASE MODHQ

MARKING DIAGRAM

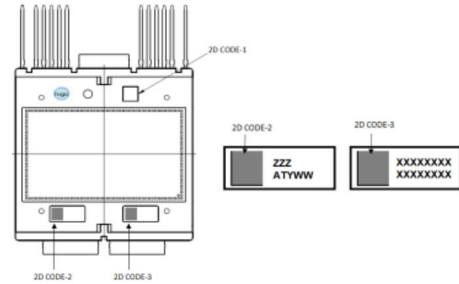

ZZZ = Assembly Lot Code
 AT = Assembly & Test Location
 Y = Year
 WW = Work Week
 XXXX = Specific Device Code

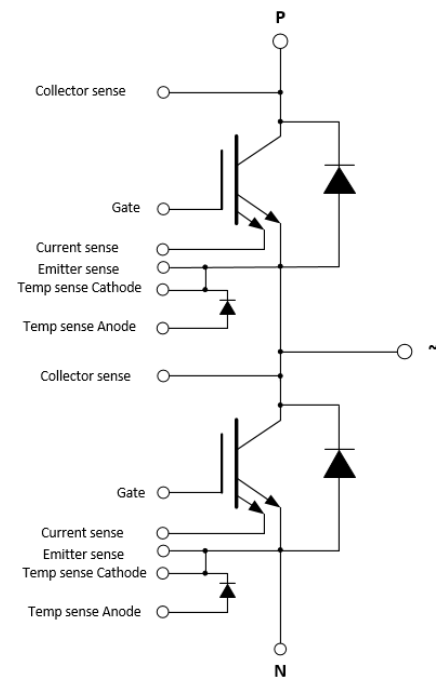

ORDERING INFORMATION

See detailed ordering and shipping information on page 10 of this data sheet.

VE-Trac™ Dual NVG600A75L4DSE2

PIN DESCRIPTION

Pin #	Pin	Pin Function Description	Pin Arrangement
1	N	Low Side Emitter	
2	P	High Side Collector	
3	H/S COLLECTOR SENSE	High Side Collector Sense	
4	H/S CURRENT SENSE	High Side Current Sense	
5	H/S EMITTER SENSE	High Side Emitter Sense	
6	H/S GATE	High Side Gate	
7	H/S TEMP SENSE (CATHODE)	High Side Temp sense Diode Cathode	
8	H/S TEMP SENSE (ANODE)	High Side Temp sense Diode Anode	
9	~	Phase Output	
10	L/S CURRENT SENSE	Low Side Current Sense	
11	L/S EMITTER SENSE	Low Side Emitter Sense	
12	L/S GATE	Low Side Gate	
13	L/S TEMP SENSE (CATHODE)	Low Side Temp sense Diode Cathode	
14	L/S TEMP SENSE (ANODE)	Low Side Temp sense Diode Anode	
15	L/S COLLECTOR SENSE	Low Side Collector Sense	

DBC Substrate

Al₂O₃ isolated substrate, basic isolation, and copper on both sides.

Lead Frame

Copper with Tin electro-plating.

Flammability Information

All materials present in the power module meet UL flammability rating class 94V-0.

MODULE CHARACTERISTICS

Symbol	Parameter	Rating	Unit		
T _{vj}	Continuous Operating Junction Temperature Range	-40 to 175	°C		
T _{STG}	Storage Temperature range	-40 to 125	°C		
V _{ISO}	Isolation Voltage, AC, f = 50 Hz, t = 1 s	4200	V		
CTI	Comparative Tracking Index	>600	-		
		Min	Typ	Max	
Creepage	Pin/Terminal to Pin/Terminal (closest location)	5.0	-	-	mm
Clearance	Pin/Terminal to Pin/Terminal (closest location)	2.9	-	-	mm
L _{sCE}	Stray Inductance	-	8	-	nH
R _{CC'+EE'}	Module Lead Resistance, Terminals - Chip	-	0.15	-	mΩ
G	Module Weight	-	75	-	g

VE-Trac™ Dual NVG600A75L4DSE2

ABSOLUTE MAXIMUM RATINGS (T_{VJ} = 25°C, unless otherwise specified)

Symbol	Parameter	Rating	Unit
--------	-----------	--------	------

IGBT

V _{CES}	Collector to Emitter Voltage	750	V
V _{GES}	Gate to Emitter Voltage	±20	V
I _{CN}	Implemented Collector Current	600	A
I _{C nom}	Continuous DC Collector Current, T _{vjmax} = 175°C, T _F = 65°C, Ref. Heatsink	500	A
I _{CRM}	Pulsed Collector Current @ V _{GE} = 15 V, t _p = 1 ms	1200	A

DIODE

V _{RRM}	Repetitive Peak Reverse Voltage	750	V
I _{FN}	Implemented Forward Current	600	A
I _F	Continuous Forward Current, T _{vjmax} = 175°C, T _F = 65°C, Ref. Heatsink	400	A
I _{FRM}	Repetitive Peak Forward Current, t _p = 1 ms	1200	A
I ² t value	V _R = 0 V, t _p = 10 ms, T _{VJ} = 150°C T _{VJ} = 175°C	14000 12000	A ² s

Stresses exceeding those listed in the Maximum Ratings table may damage the device. If any of these limits are exceeded, device functionality should not be assumed, damage may occur and reliability may be affected.

THERMAL CHARACTERISTICS

Symbol	Parameter	Min	Typ	Max	Unit
IGBT.R _{th,J-C}	Effective Rth, Junction to Case	–	0.06	0.08	°C/W
IGBT.R _{th,J-F}	Effective Rth, Junction to Fluid, λ _{TIM} = 6 W/m-K, F = 660 N 10 L/min, 65°C, 50/50 EGW, Ref. Heatsink	–	0.146	–	°C/W
Diode.R _{th,J-C}	Effective Rth, Junction to Case	–	0.10	0.13	°C/W
Diode.R _{th,J-F}	Effective Rth, Junction to Fluid, λ _{TIM} = 6 W/m-K, F = 660 N 10 L/min, 65°C, 50/50 EGW, Ref. Heatsink	–	0.196	–	°C/W

VE-Trac™ Dual NVG600A75L4DSE2

CHARACTERISTICS OF IGBT ($T_{vj} = 25^{\circ}\text{C}$, unless otherwise specified)

Parameters		Conditions	Min	Typ	Max	unit	
V_{CESAT}	Collector to Emitter Saturation Voltage	$V_{GE} = 15\text{ V}, I_C = 400\text{ A},$	$T_{vj} = 25^{\circ}\text{C}$	–	1.23	1.35	V
			$T_{vj} = 150^{\circ}\text{C}$	–	1.28	–	
			$T_{vj} = 175^{\circ}\text{C}$	–	1.30	–	
		$V_{GE} = 15\text{ V}, I_C = 600\text{ A},$	$T_{vj} = 25^{\circ}\text{C}$	–	1.39	–	
			$T_{vj} = 150^{\circ}\text{C}$	–	1.53	–	
			$T_{vj} = 175^{\circ}\text{C}$	–	1.57	–	
I_{CES}	Collector to Emitter Leakage Current	$V_{GE} = 0, V_{CE} = 750\text{ V}$	$T_{vj} = 25^{\circ}\text{C}$	–	–	1	mA
			$T_{vj} = 175^{\circ}\text{C}$	–	8	–	
I_{GES}	Gate – Emitter Leakage Current	$V_{CE} = 0, V_{GE} = \pm 20\text{ V}$	–	–	± 400	nA	
V_{th}	Threshold Voltage	$V_{CE} = V_{GE}, I_C = 500\text{ mA}$	4.5	5.6	6.5	V	
Q_G	Total Gate Charge	$V_{GE} = -8\text{ to }15\text{ V}, V_{CE} = 400\text{ V},$ $I_C = 400\text{ A}$	–	1.0	–	μC	
R_{Gint}	Internal Gate Resistance		–	2	–	Ω	
C_{ies}	Input Capacitance	$V_{CE} = 30\text{ V}, V_{GE} = 0\text{ V}, f = 1\text{ MHz}$	–	36	–	nF	
C_{oes}	Output Capacitance	$V_{CE} = 30\text{ V}, V_{GE} = 0\text{ V}, f = 1\text{ MHz}$	–	0.7	–	nF	
C_{res}	Reverse Transfer Capacitance	$V_{CE} = 30\text{ V}, V_{GE} = 0\text{ V}, f = 1\text{ MHz}$	–	0.09	–	nF	
$T_{d.on}$	Turn On Delay, Inductive Load	$I_C = 400\text{ A}, V_{CE} = 400\text{ V}$ $V_{GE} = +15/-8\text{ V}$ $R_{g.on} = 3.9\ \Omega$	$T_{vj} = 25^{\circ}\text{C}$	–	194	–	ns
			$T_{vj} = 150^{\circ}\text{C}$	–	224	–	
			$T_{vj} = 175^{\circ}\text{C}$	–	228	–	
T_r	Rise Time, Inductive Load	$I_C = 400\text{ A}, V_{CE} = 400\text{ V}$ $V_{GE} = +15/-8\text{ V}$ $R_{g.on} = 3.9\ \Omega$	$T_{vj} = 25^{\circ}\text{C}$	–	71	–	ns
			$T_{vj} = 150^{\circ}\text{C}$	–	89	–	
			$T_{vj} = 175^{\circ}\text{C}$	–	94	–	
$T_{d.off}$	Turn Off Delay, Inductive Load	$I_C = 400\text{ A}, V_{CE} = 400\text{ V}$ $V_{GE} = +15/-8\text{ V}$ $R_{g.off} = 15\ \Omega$	$T_{vj} = 25^{\circ}\text{C}$	–	969	–	ns
			$T_{vj} = 150^{\circ}\text{C}$	–	1047	–	
			$T_{vj} = 175^{\circ}\text{C}$	–	1063	–	
T_f	Fall Time, Inductive Load	$I_C = 400\text{ A}, V_{CE} = 400\text{ V}$ $V_{GE} = +15/-8\text{ V}$ $R_{g.off} = 15\ \Omega$	$T_{vj} = 25^{\circ}\text{C}$	–	123	–	ns
			$T_{vj} = 150^{\circ}\text{C}$	–	202	–	
			$T_{vj} = 175^{\circ}\text{C}$	–	230	–	
E_{ON}	Turn-On Switching Loss (Including Diode Reverse Recovery Loss)	$I_C = 400\text{ A}, V_{CE} = 400\text{ V}$ $V_{GE} = +15/-8\text{ V}$ $R_{g.on} = 3.9\ \Omega$ $L_s = 25\text{ nH}$ $di/dt (T_{vj} = 25^{\circ}\text{C}) = 4.67\text{ A/ns}$ $di/dt (T_{vj} = 175^{\circ}\text{C}) = 3.61\text{ A/ns}$	$T_{vj} = 25^{\circ}\text{C}$	–	10.09	–	mJ
			$T_{vj} = 150^{\circ}\text{C}$	–	16.73	–	
			$T_{vj} = 175^{\circ}\text{C}$	–	18.57	–	
E_{OFF}	Turn-Off Switching Loss	$I_C = 400\text{ A}, V_{CE} = 400\text{ V}$ $V_{GE} = +15/-8\text{ V}$ $R_{g.off} = 15\ \Omega$ $L_s = 25\text{ nH}$ $dv/dt (T_{vj}=25^{\circ}\text{C}) = 2.82\text{ V/ns}$ $dv/dt (T_{vj}=175^{\circ}\text{C}) = 2.08\text{ V/ns}$	$T_{vj} = 25^{\circ}\text{C}$	–	15.95	–	mJ
			$T_{vj} = 150^{\circ}\text{C}$	–	25.06	–	
			$T_{vj} = 175^{\circ}\text{C}$	–	27.30	–	
E_{sc}	Minimum Short Circuit Energy Withstand	$V_{GE} \leq 15\text{ V}, V_{CE} = 400\text{ V}$	$T_{vj} = 25^{\circ}\text{C}$	–	3.5	–	J
			$T_{vj} = 175^{\circ}\text{C}$	3.5	–	–	

VE-Trac™ Dual NVG600A75L4DSE2

CHARACTERISTICS OF INVERSE DIODE ($T_{vj} = 25^{\circ}\text{C}$, unless otherwise specified)

Parameters		Conditions	Min	Typ	Max	unit	
V_F	Diode Forward Voltage	$V_{GE} = 0\text{ V}, I_C = 400\text{ A},$	$T_{vj} = 25^{\circ}\text{C}$	–	1.34	1.47	V
			$T_{vj} = 150^{\circ}\text{C}$	–	1.30	–	
			$T_{vj} = 175^{\circ}\text{C}$	–	1.29	–	
		$V_{GE} = 0\text{ V}, I_C = 600\text{ A},$	$T_{vj} = 25^{\circ}\text{C}$	–	1.48	–	
			$T_{vj} = 150^{\circ}\text{C}$	–	1.47	–	
			$T_{vj} = 175^{\circ}\text{C}$	–	1.46	–	
E_{rr}	Reverse Recovery Energy	$V_R = 400\text{ V}, I_F = 400\text{ A},$ $R_{GON} = 3.9\ \Omega,$ $-di/dt = 3.61\text{ A/ns (175}^{\circ}\text{C)}$ $V_{GE} = -8\text{ V}$	$T_{vj} = 25^{\circ}\text{C}$	–	1.05	–	mJ
			$T_{vj} = 150^{\circ}\text{C}$	–	4.93	–	
			$T_{vj} = 175^{\circ}\text{C}$	–	5.90	–	
				–	–	–	
Q_{RR}	Recovered Charge	$V_R = 400\text{ V}, I_F = 400\text{ A},$ $R_{GON} = 3.9\ \Omega,$ $-di/dt = 3.61\text{ A/ns (175}^{\circ}\text{C)}$ $V_{GE} = -8\text{ V}$	$T_{vj} = 25^{\circ}\text{C}$	–	11.60	–	μC
			$T_{vj} = 150^{\circ}\text{C}$	–	25.72	–	
			$T_{vj} = 150^{\circ}\text{C}$	–	29.28	–	
				–	–	–	
I_{rr}	Peak Reverse Recovery Current	$V_R = 400\text{ V}, I_F = 400\text{ A},$ $R_{GON} = 3.9\ \Omega,$ $-di/dt = 3.61\text{ A/ns (175}^{\circ}\text{C)}$ $V_{GE} = -8\text{ V}$	$T_{vj} = 25^{\circ}\text{C}$	–	241	–	A
			$T_{vj} = 150^{\circ}\text{C}$	–	294	–	
			$T_{vj} = 175^{\circ}\text{C}$	–	304	–	
				–	–	–	

SENSOR CHARACTERISTICS ($T_{vj} = 25^{\circ}\text{C}$, unless otherwise specified)

Parameters		Conditions	Min	Typ	Max	unit	
T_{sense}	Temperature Sense	$I_F = 200\ \mu\text{A},$	$T_{vj} = 25^{\circ}\text{C}$	–	2.159	–	V
			$T_{vj} = 150^{\circ}\text{C}$	–	1.300	–	
			$T_{vj} = 175^{\circ}\text{C}$	–	1.186	–	
I_{sense}	Current Sense	$R_{shunt} = 0.62\ \Omega,$	$I_C = 1200\text{ A}$	–	65	–	mV
			$I_C = 600\text{ A}$	–	39	–	
			$I_C = 100\text{ A}$	–	20	–	

VE-Trac™ Dual NVG600A75L4DSE2

TYPICAL CHARACTERISTICS

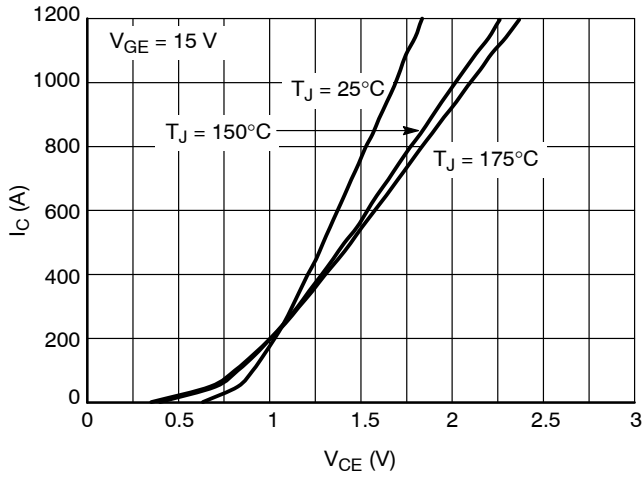

Figure 1. IGBT Output Characteristic

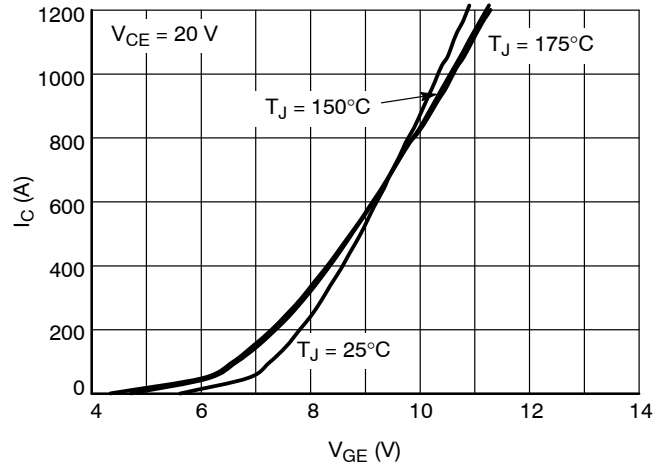

Figure 2. IGBT Transfer Characteristic

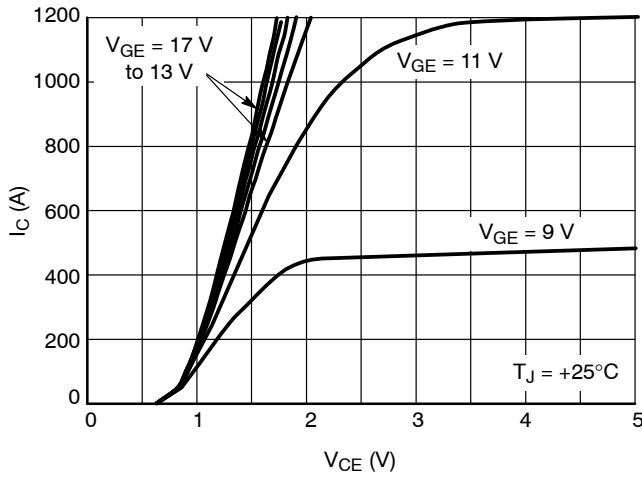

Figure 3. IGBT Output Characteristic, +25°C

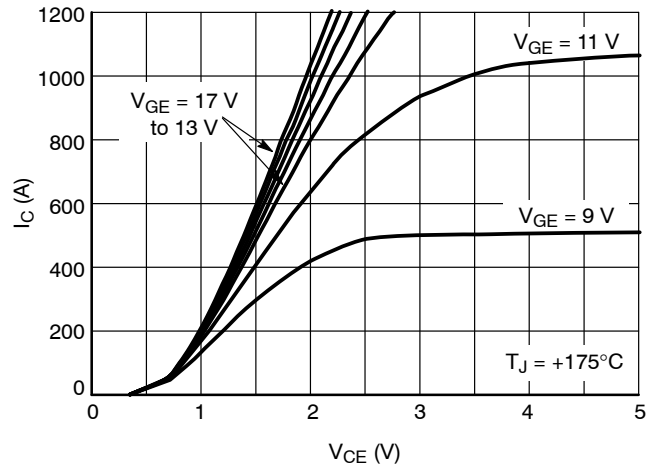

Figure 4. IGBT Output Characteristic, +175°C

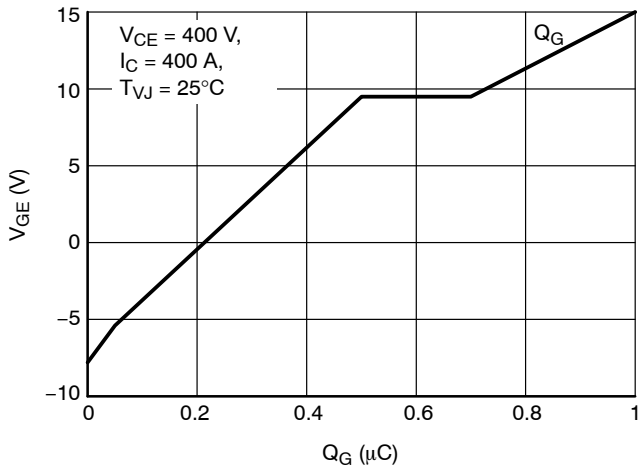

Figure 5. Gate Charge Characteristics

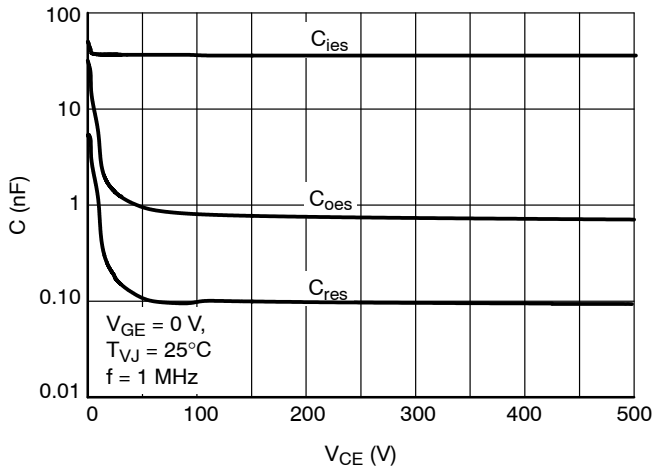

Figure 6. Capacitance Characteristics

VE-Trac™ Dual NVG600A75L4DSE2

TYPICAL CHARACTERISTICS

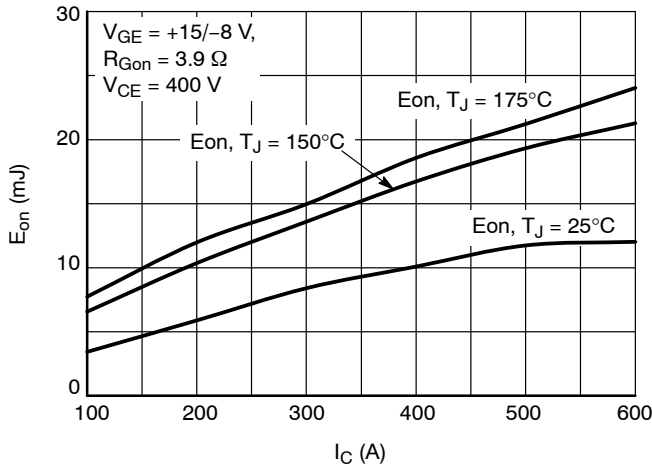

Figure 7. E_{on} vs. I_C

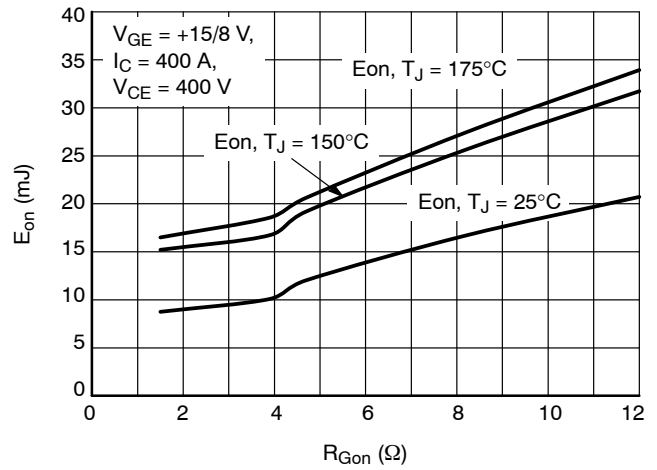

Figure 8. E_{ON} vs. R_{Gon}

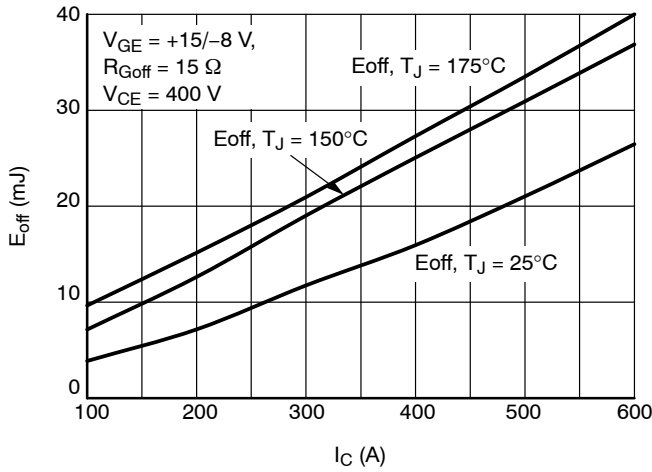

Figure 9. E_{off} vs. I_C

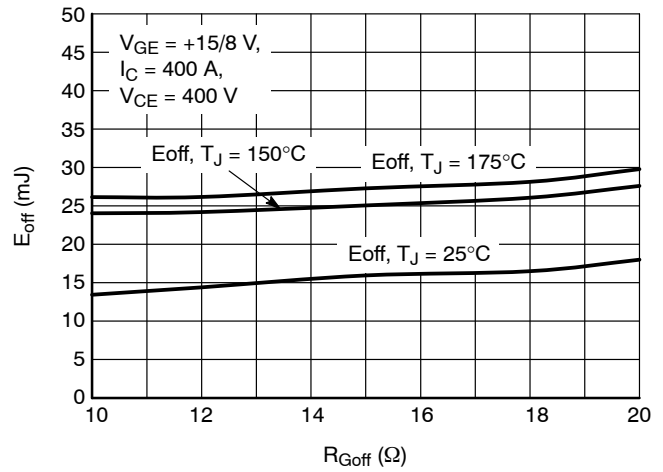

Figure 10. E_{off} vs. R_{Goff}

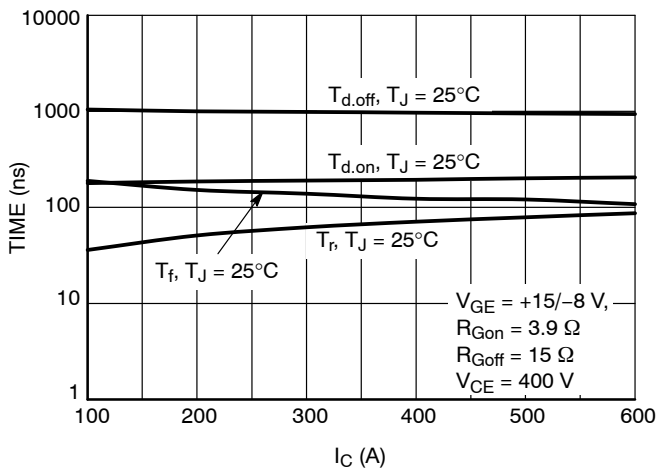

Figure 11. IGBT Switching Times vs. I_C , $T_{VJ} = 25^\circ\text{C}$

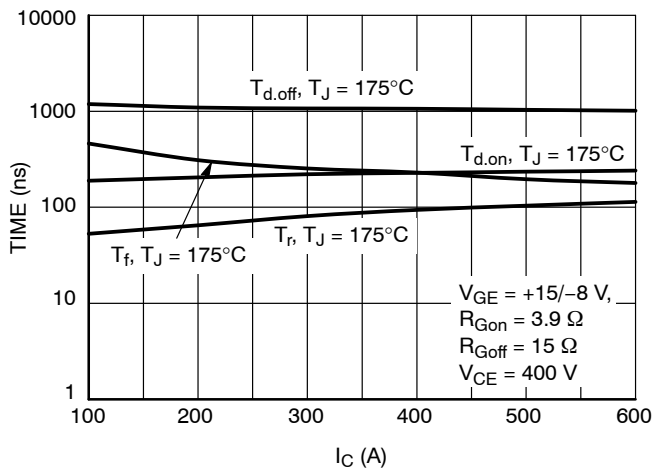

Figure 12. IGBT Switching Times vs. I_C , $T_{VJ} = 175^\circ\text{C}$

VE-Trac™ Dual NVG600A75L4DSE2

TYPICAL CHARACTERISTICS

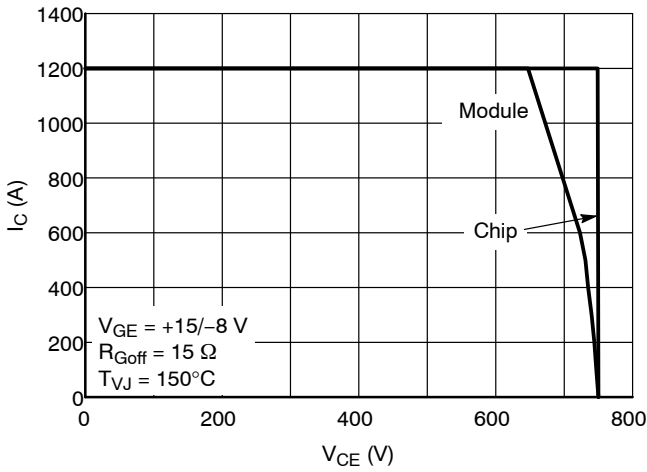

Figure 13. Reverse Bias Safe Operating Area

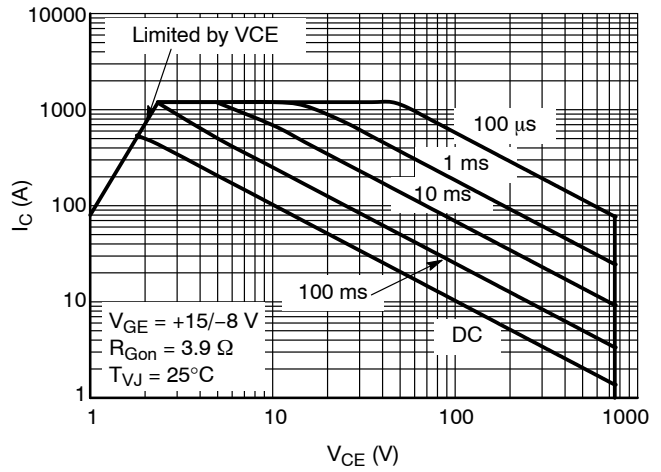

Figure 14. Forward Bias Safe Operating Area

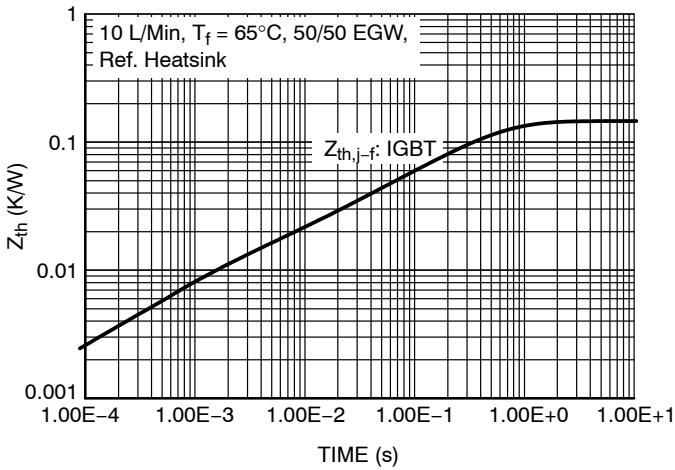

Figure 15. IGBT Transient Thermal Impedance

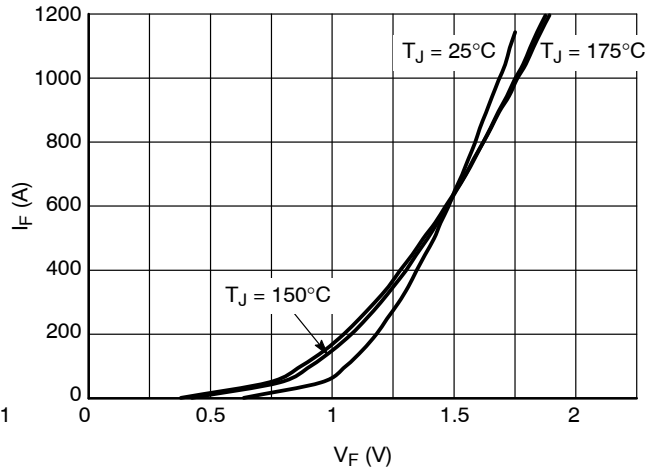

Figure 16. Diode Forward Characteristic

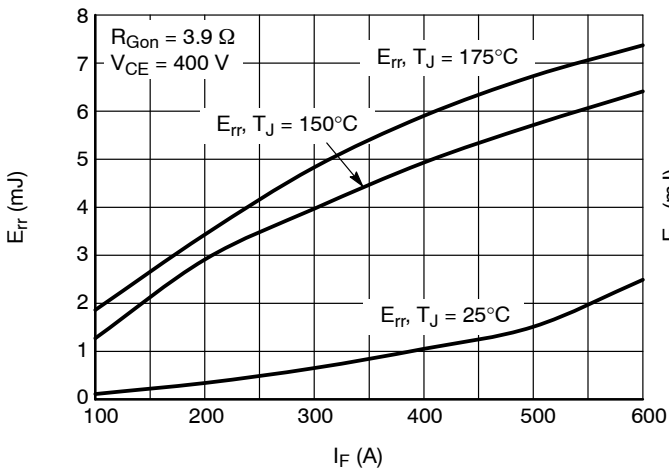

Figure 17. Diode Switching Losses vs. I_F

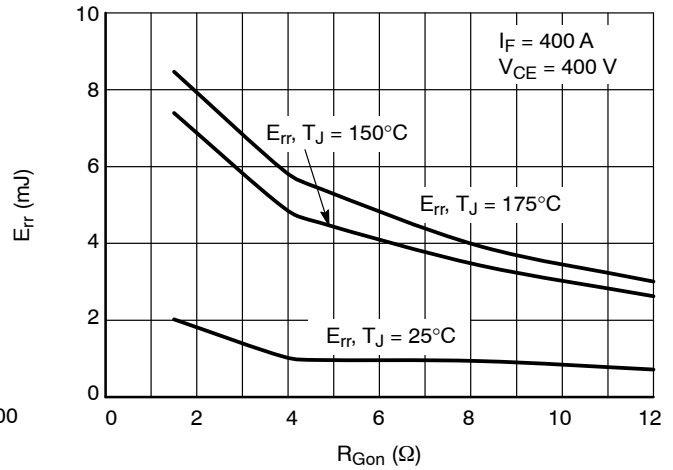

Figure 18. Diode Switching Losses vs. R_{Gon}

TYPICAL CHARACTERISTICS

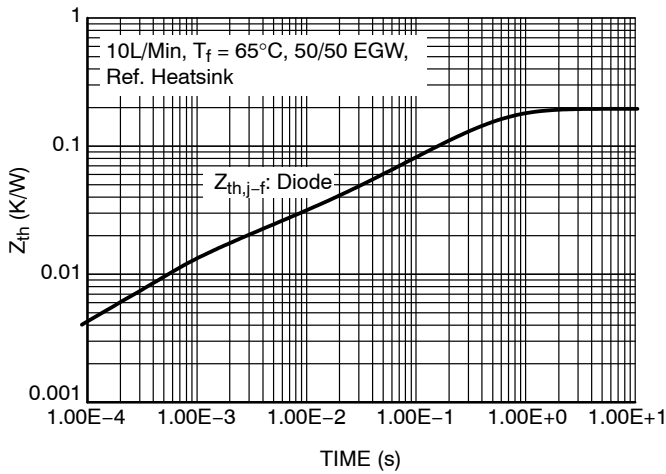

Figure 19. Diode Transient Thermal Impedance

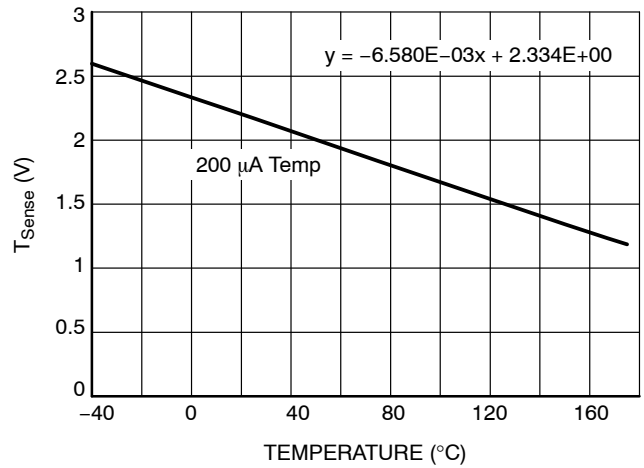

Figure 20. Temperature Sensor Characteristic

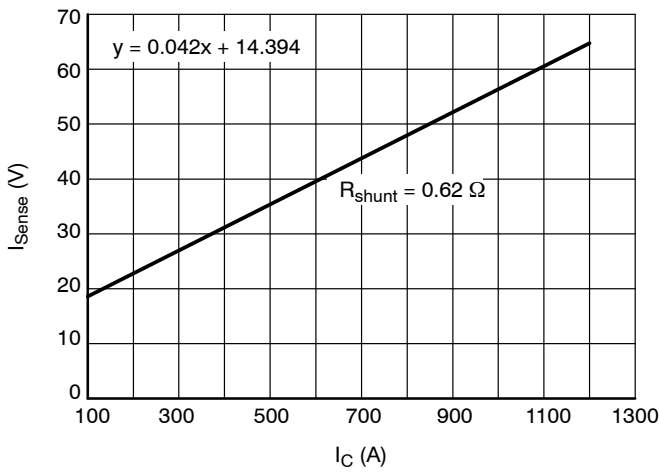

Figure 21. Current Sensor Characteristic

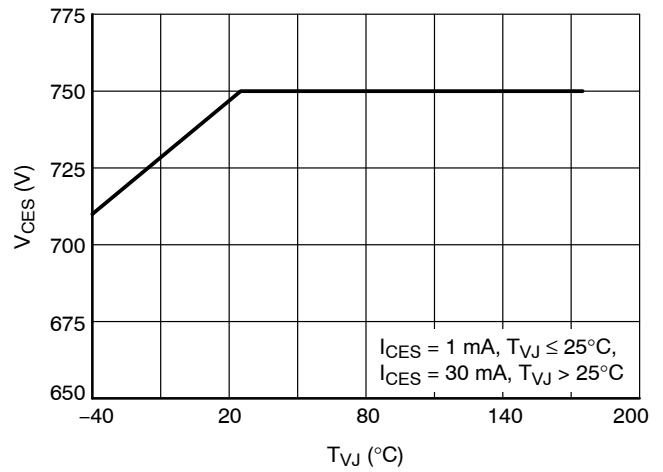

Figure 22. Maximum Allowed V_{CE}

General Note: These are preliminary values measured from a small number of DV units. Values will be updated based on higher quantity of PV measurements.

VE-Trac™ Dual NVG600A75L4DSE2

ORDERING INFORMATION

Part Number	Package	Shipping
NVG600A75L4DSE2	AHPM15-CFA Module, Case MODHQ (Pb-Free)	36 Units / 2x Blister Tray

VE-Trac is a trademark of Semiconductor Components Industries, LLC dba "onsemi" or its affiliates and/or subsidiaries in the United States and/or other countries.

MECHANICAL CASE OUTLINE

PACKAGE DIMENSIONS

ON Semiconductor®

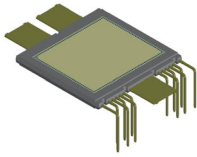

AHPM15-CFA MODULE CASE MODHQ ISSUE A

DATE 11 JUN 2021

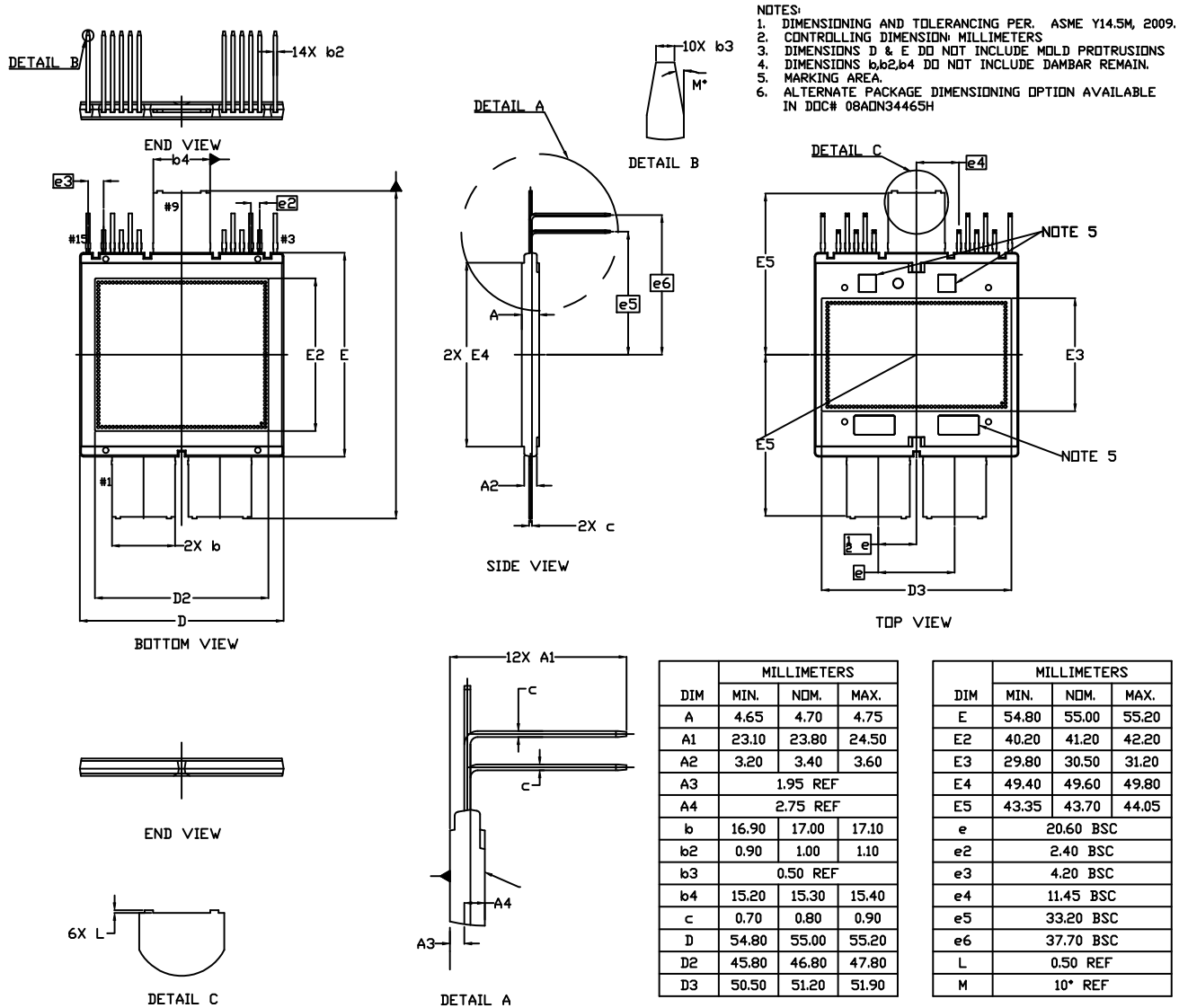

DOCUMENT NUMBER:	98AON31793H	Electronic versions are uncontrolled except when accessed directly from the Document Repository. Printed versions are uncontrolled except when stamped "CONTROLLED COPY" in red.
DESCRIPTION:	AHPM15-CFA MODULE	PAGE 1 OF 2

ON Semiconductor and are trademarks of Semiconductor Components Industries, LLC dba ON Semiconductor or its subsidiaries in the United States and/or other countries. ON Semiconductor reserves the right to make changes without further notice to any products herein. ON Semiconductor makes no warranty, representation or guarantee regarding the suitability of its products for any particular purpose, nor does ON Semiconductor assume any liability arising out of the application or use of any product or circuit, and specifically disclaims any and all liability, including without limitation special, consequential or incidental damages. ON Semiconductor does not convey any license under its patent rights nor the rights of others.

**AHPM15-CFA MODULE
CASE MODHQ
ISSUE A**

DATE 11 JUN 2021

**GENERIC
MARKING DIAGRAM***

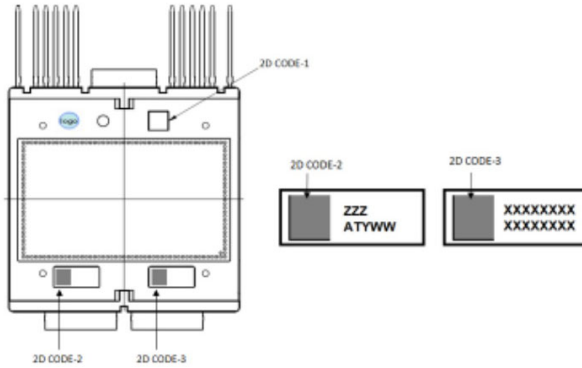

ZZZ = Assembly Lot Code
 AT = Assembly & Test Location
 Y = Year
 WW = Work Week
 XXXX = Specific Device Code

*This information is generic. Please refer to device data sheet for actual part marking. Pb-Free indicator, "G" or microdot "•", may or may not be present. Some products may not follow the Generic Marking.

DOCUMENT NUMBER:	98AON31793H	Electronic versions are uncontrolled except when accessed directly from the Document Repository. Printed versions are uncontrolled except when stamped "CONTROLLED COPY" in red.
DESCRIPTION:	AHPM15-CFA MODULE	PAGE 2 OF 2

ON Semiconductor and  are trademarks of Semiconductor Components Industries, LLC dba ON Semiconductor or its subsidiaries in the United States and/or other countries. ON Semiconductor reserves the right to make changes without further notice to any products herein. ON Semiconductor makes no warranty, representation or guarantee regarding the suitability of its products for any particular purpose, nor does ON Semiconductor assume any liability arising out of the application or use of any product or circuit, and specifically disclaims any and all liability, including without limitation special, consequential or incidental damages. ON Semiconductor does not convey any license under its patent rights nor the rights of others.

onsemi, **Onsemi**, and other names, marks, and brands are registered and/or common law trademarks of Semiconductor Components Industries, LLC dba "**onsemi**" or its affiliates and/or subsidiaries in the United States and/or other countries. **onsemi** owns the rights to a number of patents, trademarks, copyrights, trade secrets, and other intellectual property. A listing of **onsemi**'s product/patent coverage may be accessed at www.onsemi.com/site/pdf/Patent-Marking.pdf. **onsemi** reserves the right to make changes at any time to any products or information herein, without notice. The information herein is provided "as-is" and **onsemi** makes no warranty, representation or guarantee regarding the accuracy of the information, product features, availability, functionality, or suitability of its products for any particular purpose, nor does **onsemi** assume any liability arising out of the application or use of any product or circuit, and specifically disclaims any and all liability, including without limitation special, consequential or incidental damages. Buyer is responsible for its products and applications using **onsemi** products, including compliance with all laws, regulations and safety requirements or standards, regardless of any support or applications information provided by **onsemi**. "Typical" parameters which may be provided in **onsemi** data sheets and/or specifications can and do vary in different applications and actual performance may vary over time. All operating parameters, including "Typicals" must be validated for each customer application by customer's technical experts. **onsemi** does not convey any license under any of its intellectual property rights nor the rights of others. **onsemi** products are not designed, intended, or authorized for use as a critical component in life support systems or any FDA Class 3 medical devices or medical devices with a same or similar classification in a foreign jurisdiction or any devices intended for implantation in the human body. Should Buyer purchase or use **onsemi** products for any such unintended or unauthorized application, Buyer shall indemnify and hold **onsemi** and its officers, employees, subsidiaries, affiliates, and distributors harmless against all claims, costs, damages, and expenses, and reasonable attorney fees arising out of, directly or indirectly, any claim of personal injury or death associated with such unintended or unauthorized use, even if such claim alleges that **onsemi** was negligent regarding the design or manufacture of the part. **onsemi** is an Equal Opportunity/Affirmative Action Employer. This literature is subject to all applicable copyright laws and is not for resale in any manner.

ADDITIONAL INFORMATION

TECHNICAL PUBLICATIONS:

Technical Library: www.onsemi.com/design/resources/technical-documentation
onsemi Website: www.onsemi.com

ONLINE SUPPORT: www.onsemi.com/support

For additional information, please contact your local Sales Representative at www.onsemi.com/support/sales