

# IntelliMAX™ Ultra-Small, Slew-Rate-Controlled Load Switch

## FPF1203, FPF1203L, FPF1204

### Description

The FPF1203 / 03L / 04 are ultra-small integrated IntelliMAX load switches with integrated P-channel switch and analog control features. Integrated slew-rate control prevents inrush current and the resulting excessive voltage drop on the power rail. The input voltage range operates from 1.2 V to 5.5 V to provide power-disconnect capability for post-regulated power rails in portable and consumer products. The low shut-off current allows power designs to meet standby and off-power drain specifications.

The FPF120x are controlled by a logic input (ON pin) compatible with standard CMOS GPIO circuitry found on Field Programmable Gate Array (FPGA) embedded processors. The FPF120x are available in 0.76 mm x 0.76 mm 4-bump WLCSP.

### Features

- 1.2 V to 5.5 V Input Voltage Operating Range
- Typical  $R_{ON}$ :
  - ◆ 45 m $\Omega$  at  $V_{IN} = 5.5$  V
  - ◆ 55 m $\Omega$  at  $V_{IN} = 3.3$  V
  - ◆ 90 m $\Omega$  at  $V_{IN} = 1.8$  V
  - ◆ 185 m $\Omega$  at  $V_{IN} = 1.2$  V
- Slew Rate Control with  $t_{r}$ :
  - ◆ 100  $\mu$ s
- Output Discharge Function on FPF1204
- Low <1.5  $\mu$ A Quiescent Current
- ESD Protected: Above 7 kV HBM, 2 kV CDM
- GPIO / CMOS-Compatible Enable Circuitry
- 4-Bump, WLCSP 0.76 mm x 0.76 mm, 0.4 mm Pitch
- These are Pb-Free Devices

### Applications

- Mobile Devices and Smart Phones
- Portable Media Devices
- Tablet PCs
- Advanced Notebook, UMPC, MID
- Portable Medical Devices
- GPS and Navigation Equipment



ON Semiconductor®

[www.onsemi.com](http://www.onsemi.com)

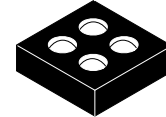

WLCSP4 0.76x0.76x0.586  
CASE 567SS

### MARKING DIAGRAM

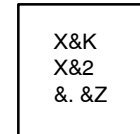

XX (QL, QP, QM, VS) = Specific Device Code  
&K = 2-Digits Lot Run Traceability Code  
&2 = 2-Digit Date Code  
&. = Pin One Dot  
&Z = Assembly Pant Code

### ORDERING INFORMATION

See detailed ordering and shipping information on page 8 of this data sheet.

# FPF1203, FPF1203L, FPF1204

## APPLICATION DIAGRAM

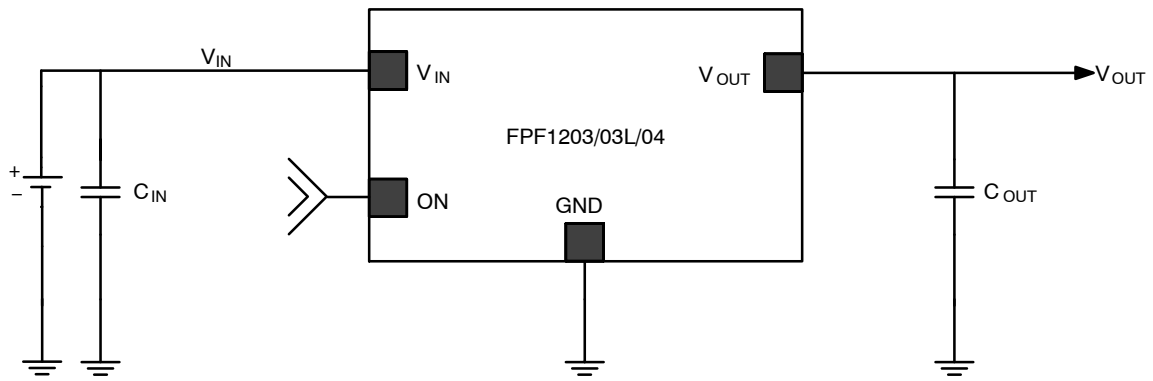

Figure 1. Typical Application

## FUNCTIONAL BLOCK DIAGRAM

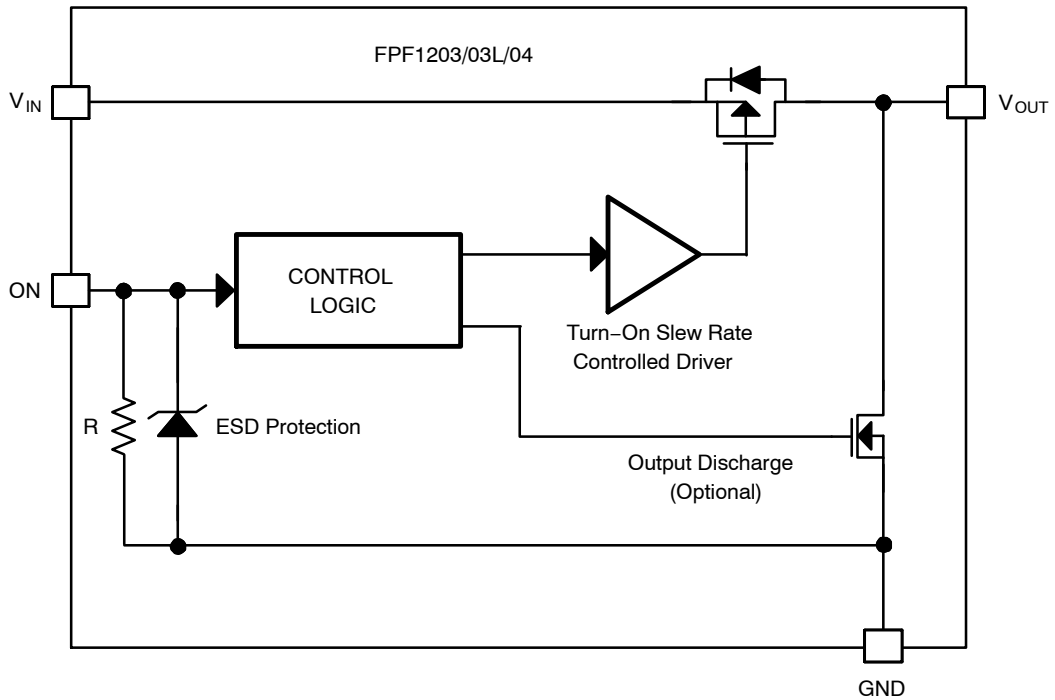

Figure 2. Functional Block Diagram (Output Discharge for FPF1204)

# FPF1203, FPF1203L, FPF1204

## PIN CONFIGURATIONS



Figure 3. WLCSP Bumps Facing Down (Top View)

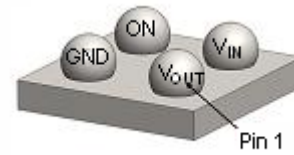

Figure 4. WLCSP Bumps Facing Up (Bottom View)

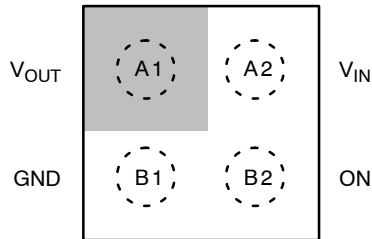

Figure 5. Pin Assignments (Top View)

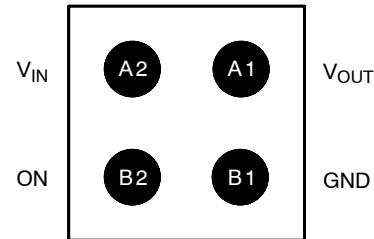

Figure 6. Pin Assignments (Bottom View)

### PIN DEFINITONS

Pin No.	Name	Description
A1	$V_{OUT}$	Switch output
A2	$V_{IN}$	Supply input: input to the power switch
B1	GND	Ground
B2	ON	ON/OFF Control, active HIGH; FPF1203/04
B2	ON	ON/OFF Control, active LOW; FPF1203L

### ABSOLUTE MAXIMUM RATINGS

Symbol	Parameter	Min	Max	Unit	
$V_{IN}$	$V_{IN}$ , $V_{OUT}$ , $V_{ON}$ to GND	-0.3	6.0	V	
$I_{SW}$	Maximum Continuous Switch Current at Ambient Operating Temperature	-	2.2	A	
$P_D$	Power Dissipation at $T_A = 25^\circ\text{C}$	-	1.0	W	
$T_{STG}$	Storage Temperature Range	-65	+150	$^\circ\text{C}$	
$\Theta_{JA}$	Thermal Resistance, Junction-to-Ambient	1S2P with One Thermal Via (Note 1)	-	110	$^\circ\text{C/W}$
		1S2P without Thermal Via (Note 2)	-	95	
ESD	Electrostatic Discharge Capability (Note 1, 2)	Human Body Model, JESD22-A114	7	-	kV
		Charged Device Model, JESD22-C101	2	-	

Stresses exceeding those listed in the Maximum Ratings table may damage the device. If any of these limits are exceeded, device functionality should not be assumed, damage may occur and reliability may be affected.

1. Measured using 2S2P JEDEC std. PCB.
2. Measured using 2S2P JEDEC PCB COLD PLATE Method.

# FPF1203, FPF1203L, FPF1204

## RECOMMENDED OPERATING CONDITIONS

Symbol	Parameter	Min	Max	Unit
$V_{IN}$	Input Voltage	1.2	5.5	V
$T_A$	Ambient Operating Temperature	-40	+85	°C

Functional operation above the stresses listed in the Recommended Operating Ranges is not implied. Extended exposure to stresses beyond the Recommended Operating Ranges limits may affect device reliability.

**ELECTRICAL CHARACTERISTICS** (Unless otherwise noted,  $V_{IN} = 1.2$  V to 5.5 V and  $T_A = -40$  to +85°C. Typical values are at  $V_{IN} = 3.3$  V and  $T_A = 25$ °C.)

Symbol	Parameter	Condition	Min	Typ	Max	Unit
--------	-----------	-----------	-----	-----	-----	------

## BASIC OPERATION

$V_{IN}$	Supply Voltage		1.2	-	5.5	V	
$I_{Q(OFF)}$	Off Supply Current	FPF1203/04	$V_{ON} = GND, V_{OUT} = \text{Open}, V_{IN} = 5.5$ V	-	0.1	1.0	$\mu$ A
		FPF1203L	$V_{ON} = V_{IN}, V_{OUT} = \text{Open}, V_{IN} = 5.5$ V	-	1.0	2.0	
$I_{SD}$	Shutdown Current	FPF1203/04	$V_{ON} = GND, V_{OUT} = GND$	-	0.1	1.0	$\mu$ A
		FPF1203L	$V_{ON} = V_{IN}, V_{OUT} = GND$	-	1.2	3.0	
$I_Q$	Quiescent Current	FPF1203/04	$I_{OUT} = 0$ mA, $V_{ON} = V_{IN}, = 5.5$ V	-	0.1	1.5	$\mu$ A
		FPF1203L	$I_{OUT} = 0$ mA, $V_{ON} = GND, V_{IN}, = 5.5$ V				
$R_{ON}$	On Resistance		$V_{IN} = 5.5$ V, $I_{OUT} = 200$ mA, $T_A = 25$ °C	-	45	55 (Note 3)	m $\Omega$
			$V_{IN} = 3.3$ V, $I_{OUT} = 200$ mA, $T_A = 25$ °C	-	55	65 (Note 3)	
			$V_{IN} = 1.8$ V, $I_{OUT} = 200$ mA, $T_A = 25$ °C	-	90	100 (Note 3)	
			$V_{IN} = 1.2$ V, $I_{OUT} = 200$ mA, $T_A = 25$ °C	-	185	220 (Note 3)	
			$V_{IN} = 1.8$ V, $I_{OUT} = 200$ mA, $T_A = 85$ °C (Note 3)	-	-	105	
$R_{PD}$	Output Discharge $R_{PULL\ DOWN}$		$V_{IN} = 3.3$ V, $V_{ON} = \text{OFF}, I_{FORCE} = 20$ mA, $T_A = 25$ °C, FPF1204	-	65	75	$\Omega$
$V_{IH}$	On Input Logic HIGH Voltage		$V_{IN} = 1.2$ V to 5.5 V	1.15	-	-	V
$V_{IL}$	On Input Logic LOW Voltage		$V_{IN} = 1.2$ V to 5.5 V	-	-	0.65	V
$R_{ON\_PD}$	Pull-Down Resistance at ON Pin		$V_{IN} = 1.2$ V to 5.5 V	-	8.3	-	M $\Omega$
$I_{ON}$	On Input Leakage		$V_{ON} = V_{IN}$ or GND	-	-	1	$\mu$ A

## DYNAMIC CHARACTERISTICS

$t_{DON}$	Turn-On Delay (Note 4)	$V_{IN} = 3.3$ V, $R_L = 10$ $\Omega$ , $C_L = 0.1$ $\mu$ F, $T_A = 25$ °C, FPF1204	-	70	-	$\mu$ s
$t_R$	$V_{OUT}$ Rise Time (Note 4)		-	100	-	
$t_{ON}$	Turn-On Time (Note 6)		-	170	-	
$t_{DOFF}$	Turn-Off Delay (Note 4, 5)	$V_{IN} = 3.3$ V, $R_L = 10$ $\Omega$ , $C_L = 0.1$ $\mu$ F, $T_A = 25$ °C, FPF1203L	-	0.5	-	$\mu$ s
$t_F$	$V_{OUT}$ Fall Time (Note 4, 5)		-	2.0	-	
$t_{OFF}$	Turn-Off Time (Note 5, 7)		-	2.5	-	
$t_{DOFF}$	Turn-Off Delay (Note 4, 5)	$V_{IN} = 3.3$ V, $R_L = 500$ $\Omega$ , $C_L = 0.1$ $\mu$ F, $T_A = 25$ °C, FPF1203L	-	6	-	$\mu$ s
$t_F$	$V_{OUT}$ Fall Time (Note 4, 5)		-	115	-	
$t_{OFF}$	Turn-Off Time (Note 5, 7)		-	121	-	
$t_{DOFF}$	Turn-Off Delay (Note 4, 5)	$V_{IN} = 3.3$ V, $R_L = 10$ $\Omega$ , $C_L = 0.1$ $\mu$ F, $T_A = 25$ °C, FPF1203	-	4.0	-	$\mu$ s
$t_F$	$V_{OUT}$ Fall Time (Note 4, 5)		-	2.9	-	
$t_{OFF}$	Turn-Off Time (Note 5, 7)		-	7.3	-	

# FPF1203, FPF1203L, FPF1204

**ELECTRICAL CHARACTERISTICS** (Unless otherwise noted,  $V_{IN} = 1.2\text{ V}$  to  $5.5\text{ V}$  and  $T_A = -40$  to  $+85^\circ\text{C}$ . Typical values are at  $V_{IN} = 3.3\text{ V}$  and  $T_A = 25^\circ\text{C}$ .) (continued)

Symbol	Parameter	Condition	Min	Typ	Max	Unit
<b>DYNAMIC CHARACTERISTICS</b>						
$t_{DOFF}$	Turn-Off Delay (Note 4, 5)	$V_{IN} = 3.3\text{ V}$ , $R_L = 500\ \Omega$ , $C_L = 0.1\ \mu\text{F}$ , $T_A = 25^\circ\text{C}$ , FPF1203	–	6	–	$\mu\text{s}$
$t_F$	$V_{OUT}$ Fall Time (Note 4, 5)		–	115	–	
$t_{OFF}$	Turn-Off Time (Note 5, 7)		–	121	–	
$t_{DOFF}$	Turn-Off Delay (Note 4, 5)	$V_{IN} = 3.3\text{ V}$ , $R_L = 10\ \Omega$ , $C_L = 0.1\ \mu\text{F}$ , $T_A = 25^\circ\text{C}$ , FPF1204 (Note 5)	–	4.0	–	$\mu\text{s}$
$t_F$	$V_{OUT}$ Fall Time (Note 4, 5)		–	2.5	–	
$t_{OFF}$	Turn-Off Time (Note 5, 7)		–	6.5	–	
$t_{DOFF}$	Turn-Off Delay (Note 4, 5)	$V_{IN} = 3.3\text{ V}$ , $R_L = 500\ \Omega$ , $C_L = 0.1\ \mu\text{F}$ , $T_A = 25^\circ\text{C}$ , FPF1204 (Note 5)	–	6	–	$\mu\text{s}$
$t_F$	$V_{OUT}$ Fall Time (Note 4, 5)		–	11	–	
$t_{OFF}$	Turn-Off Time (Note 5, 7)		–	17	–	

Product parametric performance is indicated in the Electrical Characteristics for the listed test conditions, unless otherwise noted. Product performance may not be indicated by the Electrical Characteristics if operated under different conditions.

3. This parameter is guaranteed by design and characterization; not production tested.

4.  $t_{DON}$  /  $t_{DOFF}$  /  $t_R$  /  $t_F$  are defined in Figure 23.

5. Output discharge enabled during off-state.

6.  $t_{ON} = t_R + t_{DON}$

7.  $t_{OFF} = t_F + t_{DOFF}$

## TYPICAL PERFORMANCE CHARACTERISTICS

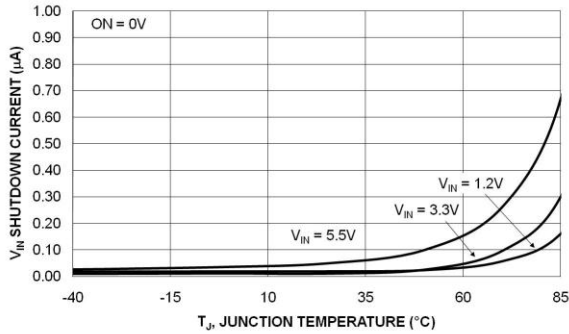

Figure 7. Shutdown Current vs. Temperature

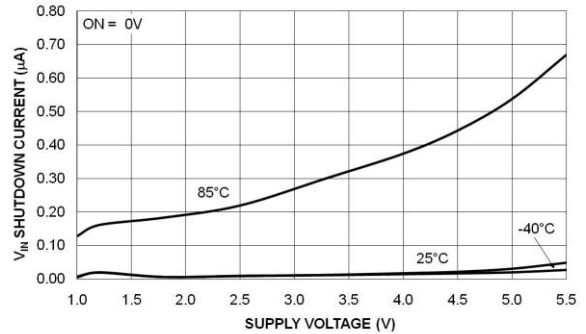

Figure 8. Shutdown Current vs. Supply Voltage

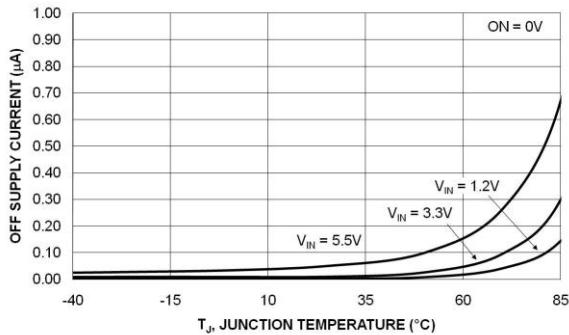

Figure 9. Off Supply Current vs. Temperature ( $V_{OUT}$  Floating)

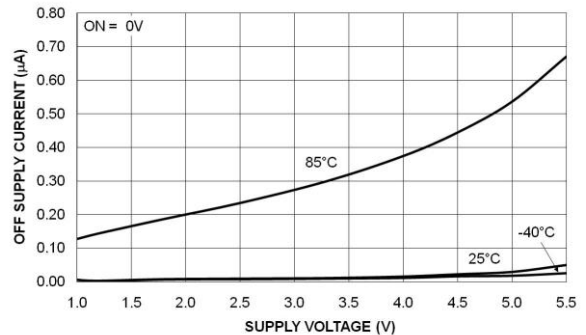

Figure 10. Off Supply Current vs. Supply Voltage ( $V_{OUT}$  Floating)

TYPICAL PERFORMANCE CHARACTERISTICS (Continued)

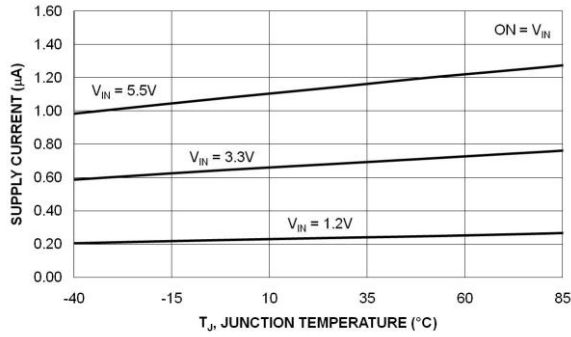

Figure 11. Quiescent Current vs. Temperature

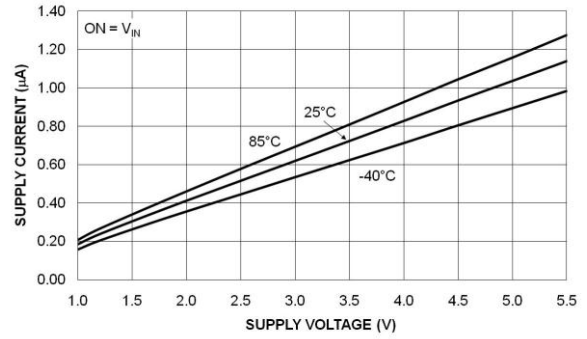

Figure 12. Quiescent Current vs. Supply Voltage

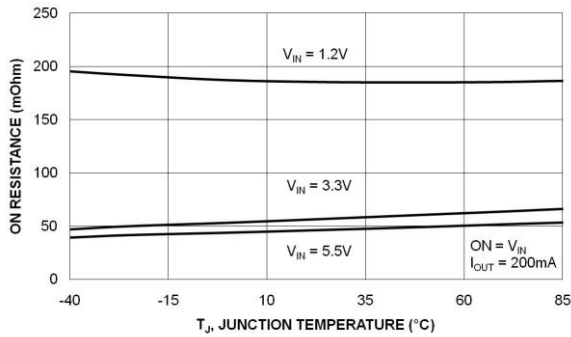

Figure 13.  $R_{ON}$  vs. Temperature

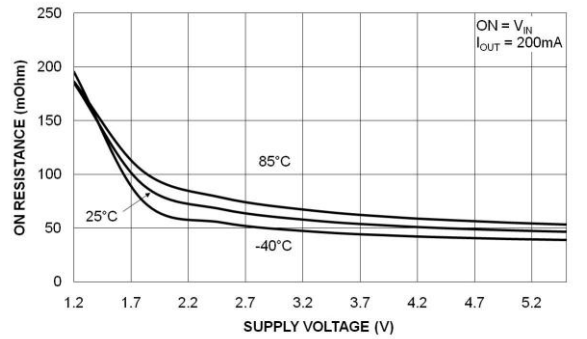

Figure 14.  $R_{ON}$  vs. Supply Voltage

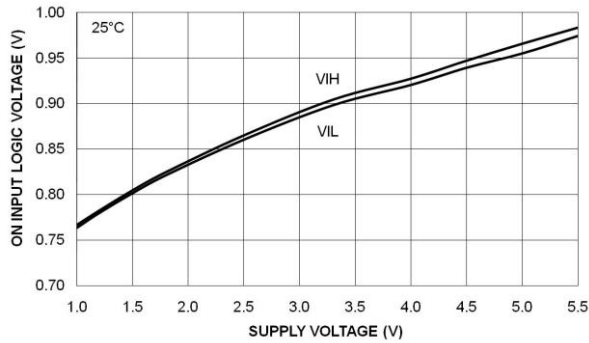

Figure 15. ON Pin Threshold vs.  $V_{IN}$

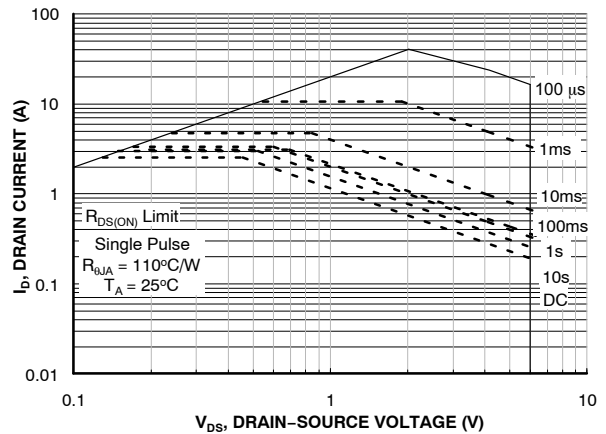

Figure 16. Drain Current vs. Drain-Source Voltage Safe Operating Area

# FPF1203, FPF1203L, FPF1204

## TYPICAL PERFORMANCE CHARACTERISTICS (Continued)

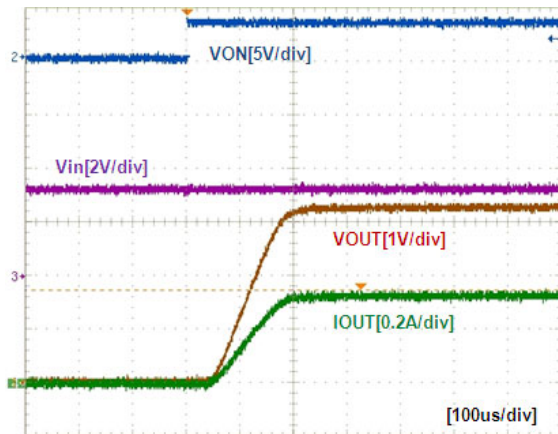

Figure 17. Turn-On Response – FPF1203 / 04  
 $(V_{IN} = 3.3\text{ V}, C_{IN} = 1\ \mu\text{F}, C_{OUT} = 0.1\ \mu\text{F}, R_L = 10\ \Omega)$

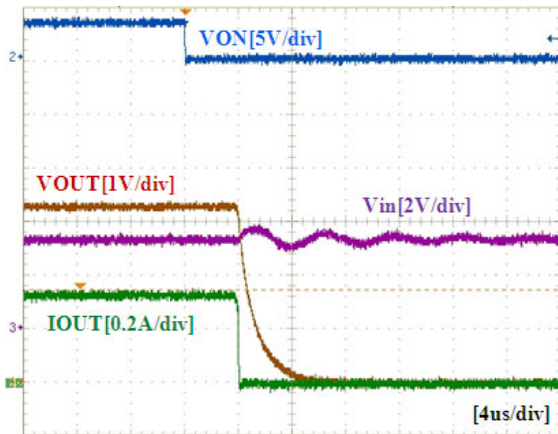

Figure 18. Turn-Off Response – FPF1203  
 $(V_{IN} = 3.3\text{ V}, C_{IN} = 1\ \mu\text{F}, C_{OUT} = 0.1\ \mu\text{F}, R_L = 10\ \Omega)$

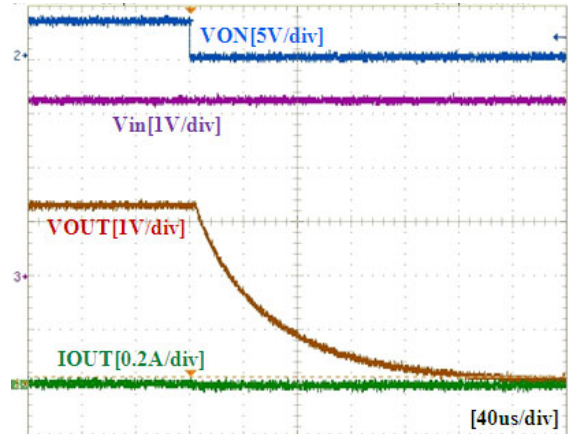

Figure 19. Turn-Off Response – FPF1203  
 $(V_{IN} = 3.3\text{ V}, C_{IN} = 1\ \mu\text{F}, C_{OUT} = 0.1\ \mu\text{F}, R_L = 500\ \Omega)$

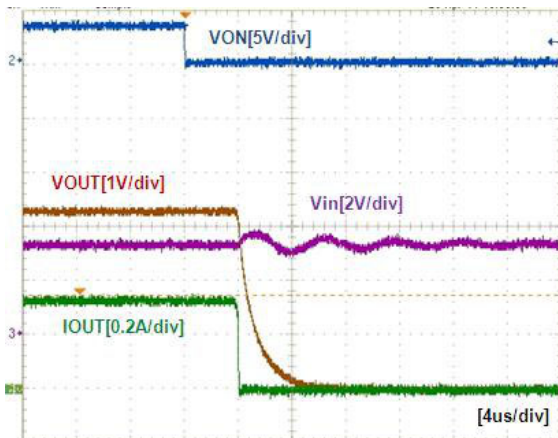

Figure 20. Turn-Off Response ( $V_{IN} = 3.3\text{ V}, C_{IN} = 1\ \mu\text{F}, C_{OUT} = 0.1\ \mu\text{F}, R_L = 10\ \Omega, \text{FPF1204}$ )

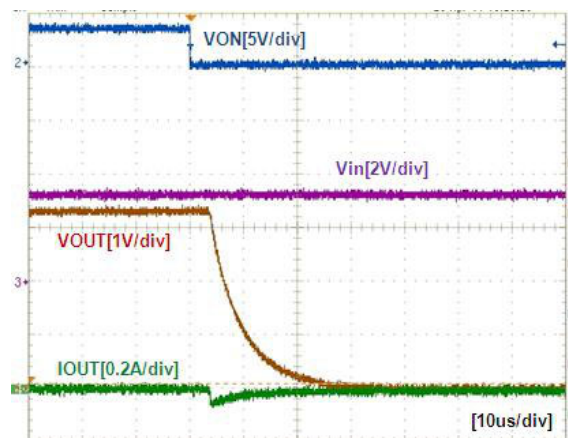

Figure 21. Turn-Off Response ( $V_{IN} = 3.3\text{ V}, C_{IN} = 1\ \mu\text{F}, C_{OUT} = 0.1\ \mu\text{F}, R_L = 500\ \Omega, \text{FPF1204}$ )



# FPF1203, FPF1203L, FPF1204

## OPERATION AND APPLICATION DESCRIPTION

The FPF1203 / 03L / 04 are low- $R_{ON}$  P-channel load switches with controlled turn-on. The core of each device is a 55 m $\Omega$  P-channel MOSFET and controller capable of functioning over a wide input operating range of 1.2 to 5.5 V.

The FPF1204 contain a 65  $\Omega$  on-chip load resistor for quick output discharge when the switch is turned off.

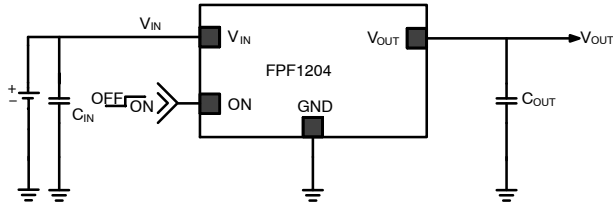

Figure 22. Typical Application

### Input Capacitor

To limit the voltage drop on the input supply caused by transient inrush current when the switch turns on into a discharged load capacitor or short-circuit, a capacitor must be placed between the  $V_{IN}$  and GND pins. A 1  $\mu$ F ceramic capacitor,  $C_{IN}$ , placed close to the pins is usually sufficient. Higher-value  $C_{IN}$  can be used to reduce the voltage drop in higher-current applications.

### Output Capacitor

A 0.1  $\mu$ F capacitor,  $C_{OUT}$ , should be placed between the  $V_{OUT}$  and GND pins. This capacitor prevents parasitic board inductance from forcing  $V_{OUT}$  below GND when the switch is on.  $C_{IN}$  greater than  $C_{OUT}$  is highly recommended.

$C_{OUT}$  greater than  $C_{IN}$  can cause  $V_{OUT}$  to exceed  $V_{IN}$  when the system supply is removed. This could result in current flow through the body diode from  $V_{OUT}$  to  $V_{IN}$ .

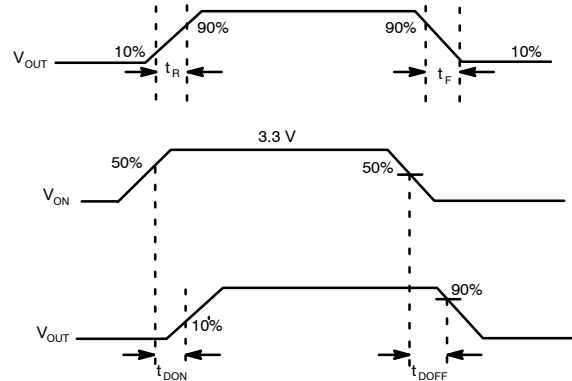

Figure 23. Timing Diagram for FPF1203/4

### Board Layout

For best performance, traces should be as short as possible. To be most effective, input and output capacitors should be placed close to the device to minimize the effect of parasitic trace inductance on normal and short-circuit operation. Using wide traces or large copper planes for all pins ( $V_{IN}$ ,  $V_{OUT}$ , ON, and GND) minimizes the parasitic electrical effects and the case-ambient thermal impedance. However, the  $V_{OUT}$  pin should not connect directly to the battery source due to the discharge mechanism of the load switch.

## ORDERING INFORMATION

Part Number	Top Mark	Switch (Typical) at 3.3V <sub>IN</sub>	Output Discharge	ON Pin Activity	t <sub>R</sub>	Package	Shipping†
FPF1203UCX	QL	55 m $\Omega$	NA	Active HIGH	100 $\mu$ s	4-Bump, Wafer-Level Chip-Scale Package (WLCSP), 0.76 mm x 0.76 mm, 0.4 mm Pitch	3000 / Tape & Reel
FPF1203LUCX	QP	55 m $\Omega$	NA	Active LOW	100 $\mu$ s		3000 / Tape & Reel
FPF1204UCX	QM	55 m $\Omega$	65 $\Omega$	Active HIGH	100 $\mu$ s		3000 / Tape & Reel

†For information on tape and reel specifications, including part orientation and tape sizes, please refer to our Tape and Reel Packaging Specifications Brochure, BRD8011/D.

The table below pertains to the Packaging information on the following page.

## PRODUCT DIMENSIONS

D	E	X	Y
760 $\mu$ m $\pm$ 30 $\mu$ m	760 $\mu$ m $\pm$ 30 $\mu$ m	0.180 mm $\pm$ 0.018 $\mu$ m	0.180 mm $\pm$ 0.018 $\mu$ m



**MECHANICAL CASE OUTLINE**  
**PACKAGE DIMENSIONS**

ON Semiconductor®



**WLCSP4 0.76x0.76x0.586**  
CASE 567SS  
ISSUE O

DATE 30 NOV 2016

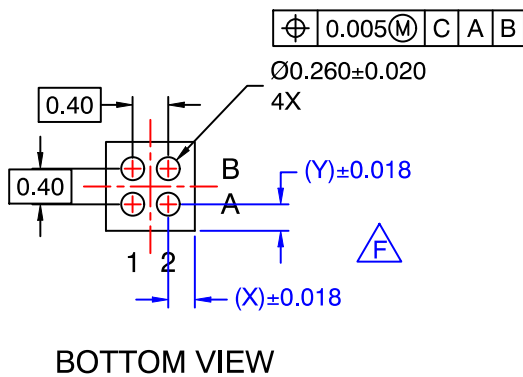
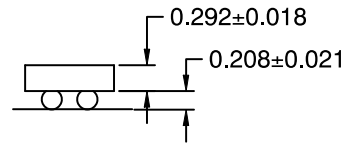
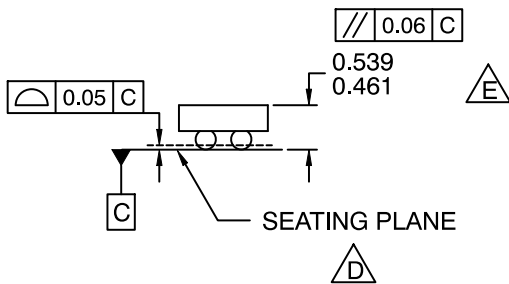
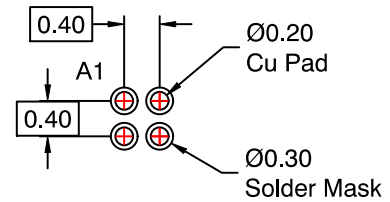
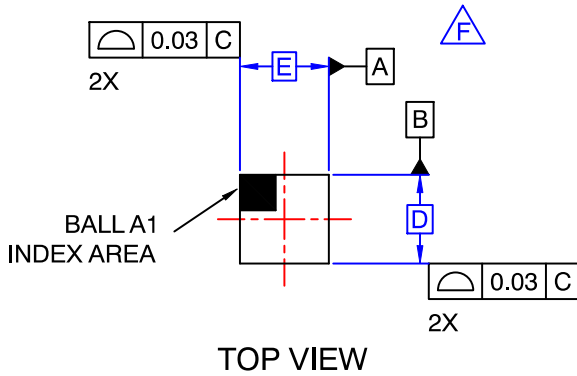

**NOTES:**

- A. NO JEDEC REGISTRATION APPLIES.
- B. DIMENSIONS ARE IN MILLIMETERS.
- C. DIMENSIONS AND TOLERANCE PER ASME Y14.5M, 1994.
- D** DATUM C IS DEFINED BY THE SPHERICAL CROWNS OF THE BALLS.
- E** PACKAGE NOMINAL HEIGHT IS 500 MICRONS ±39 MICRONS (461–539 MICRONS).
- F** FOR DIMENSIONS D, E, X, AND Y SEE PRODUCT DATASHEET.

<b>DOCUMENT NUMBER:</b>	<b>98AON16616G</b>	Electronic versions are uncontrolled except when accessed directly from the Document Repository. Printed versions are uncontrolled except when stamped "CONTROLLED COPY" in red.
<b>DESCRIPTION:</b>	<b>WLCSP4 0.76x0.76x0.586</b>	<b>PAGE 1 OF 1</b>

ON Semiconductor and are trademarks of Semiconductor Components Industries, LLC dba ON Semiconductor or its subsidiaries in the United States and/or other countries. ON Semiconductor reserves the right to make changes without further notice to any products herein. ON Semiconductor makes no warranty, representation or guarantee regarding the suitability of its products for any particular purpose, nor does ON Semiconductor assume any liability arising out of the application or use of any product or circuit, and specifically disclaims any and all liability, including without limitation special, consequential or incidental damages. ON Semiconductor does not convey any license under its patent rights nor the rights of others.

**onsemi**, **Onsemi**, and other names, marks, and brands are registered and/or common law trademarks of Semiconductor Components Industries, LLC dba "**onsemi**" or its affiliates and/or subsidiaries in the United States and/or other countries. **onsemi** owns the rights to a number of patents, trademarks, copyrights, trade secrets, and other intellectual property. A listing of **onsemi**'s product/patent coverage may be accessed at [www.onsemi.com/site/pdf/Patent-Marking.pdf](http://www.onsemi.com/site/pdf/Patent-Marking.pdf). **onsemi** reserves the right to make changes at any time to any products or information herein, without notice. The information herein is provided "as-is" and **onsemi** makes no warranty, representation or guarantee regarding the accuracy of the information, product features, availability, functionality, or suitability of its products for any particular purpose, nor does **onsemi** assume any liability arising out of the application or use of any product or circuit, and specifically disclaims any and all liability, including without limitation special, consequential or incidental damages. Buyer is responsible for its products and applications using **onsemi** products, including compliance with all laws, regulations and safety requirements or standards, regardless of any support or applications information provided by **onsemi**. "Typical" parameters which may be provided in **onsemi** data sheets and/or specifications can and do vary in different applications and actual performance may vary over time. All operating parameters, including "Typicals" must be validated for each customer application by customer's technical experts. **onsemi** does not convey any license under any of its intellectual property rights nor the rights of others. **onsemi** products are not designed, intended, or authorized for use as a critical component in life support systems or any FDA Class 3 medical devices or medical devices with a same or similar classification in a foreign jurisdiction or any devices intended for implantation in the human body. Should Buyer purchase or use **onsemi** products for any such unintended or unauthorized application, Buyer shall indemnify and hold **onsemi** and its officers, employees, subsidiaries, affiliates, and distributors harmless against all claims, costs, damages, and expenses, and reasonable attorney fees arising out of, directly or indirectly, any claim of personal injury or death associated with such unintended or unauthorized use, even if such claim alleges that **onsemi** was negligent regarding the design or manufacture of the part. **onsemi** is an Equal Opportunity/Affirmative Action Employer. This literature is subject to all applicable copyright laws and is not for resale in any manner.

## ADDITIONAL INFORMATION

### TECHNICAL PUBLICATIONS:

Technical Library: [www.onsemi.com/design/resources/technical-documentation](http://www.onsemi.com/design/resources/technical-documentation)  
onsemi Website: [www.onsemi.com](http://www.onsemi.com)

### ONLINE SUPPORT: [www.onsemi.com/support](http://www.onsemi.com/support)

For additional information, please contact your local Sales Representative at [www.onsemi.com/support/sales](http://www.onsemi.com/support/sales)