

# CM1454

## Data Port EMI Filter Array with ESD Protection

### Description

The CM1454 is an EMI filter array with ESD protection in a CSP form factor for the data port of a mobile handset. The CM1454-08 is configured in an 8 channel format and combines both resistor-capacitor (R-C) and inductor-capacitor (L-C) filters in the chip. There are five C-R-C filters with component values of 30 pF – 100 Ω – 30 pF which are used for the microphone and data ports. There are also three C-L-C filters with values of 80 pF – 3 nH – 80 pF which are designed for the stereo speaker port.

The CM1454's C-RC filters have a cut-off frequency of 60 MHz and an attenuation of better than 35 dB over the 800 MHz to 2.7 GHz frequency range. The C-L-C filters have a cut-off frequency of 21 MHz with an attenuation of 40 dB at 1 GHz. The parts integrate ESD protection diodes on every pin that provide a very high level of protection for sensitive electronic components against possible electrostatic discharge (ESD). The ESD protection diodes connected to the filter ports are designed and characterized to safely dissipate ESD strikes of ±15 kV, which is beyond the Level 4 requirement of the IEC61000-4-2 international standard. In accordance with MIL-STD-883 (Method 3015) specification for Human Body Model (HBM) ESD, the pins are also protected for contact discharges at greater than ±30 kV.

The CM1454 incorporates *OptiGuard™* which results in improved reliability at assembly. The CM1454 is available in a space saving, low profile Chip Scale Package with RoHS compliant lead-free finishing.

### Features

- *OptiGuard™* Coated for Improved Reliability
- Eight Channels of EMI Filtering
- Three C-L-C Filters with ESD Protection for Stereo Speaker Port
- Five C-R-C Filters with ESD Protection for Microphone and Data Ports
- ±15 kV ESD Protection on Each Channel (IEC 61000-4-2 Level 4, Contact Discharge)
- ±30 kV ESD Protection on Each Channel (HBM)
- Chip Scale Package (CSP) Features Extremely Low Parasitic Inductance for Optimum Filter and ESD Performance
- 20-Bump, 3.960 mm x 1.586 mm Footprint CSP
- These Devices are Pb-Free and are RoHS Compliant

### Applications

- Combination I/O Data Port that has I/Os for Data, Microphone and Speaker
- I/O Port Protection for Mobile Handsets, Notebook Computers, PDAs, etc.
- EMI Filtering for Data Ports in Cell Phones, PDAs or Notebook Computers
- Wireless Handsets
- Handheld PCs / PDAs



ON Semiconductor®

<http://onsemi.com>



WLCSP20  
CP SUFFIX  
CASE 567BY

### MARKING DIAGRAM

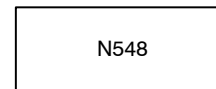

CM1454-08  
20-Bump CSP Package

N548 = CM1454-08CP

### ORDERING INFORMATION

Device	Package	Shipping†
CM1454-08CP	CSP-20 (Pb-Free)	3500/Tape & Reel

†For information on tape and reel specifications, including part orientation and tape sizes, please refer to our Tape and Reel Packaging Specification Brochure, BRD8011/D.

# CM1454

## ELECTRICAL SCHEMATIC

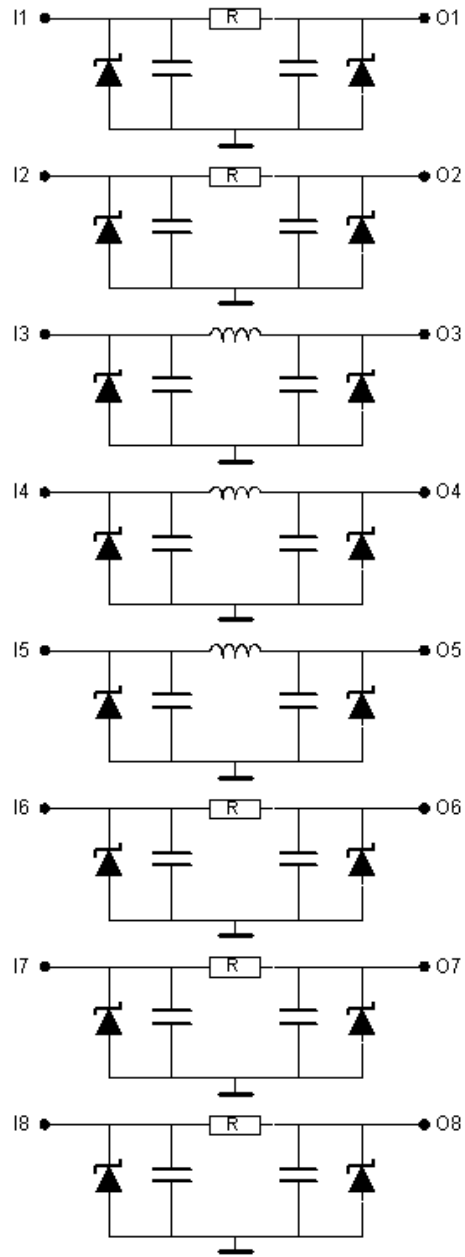
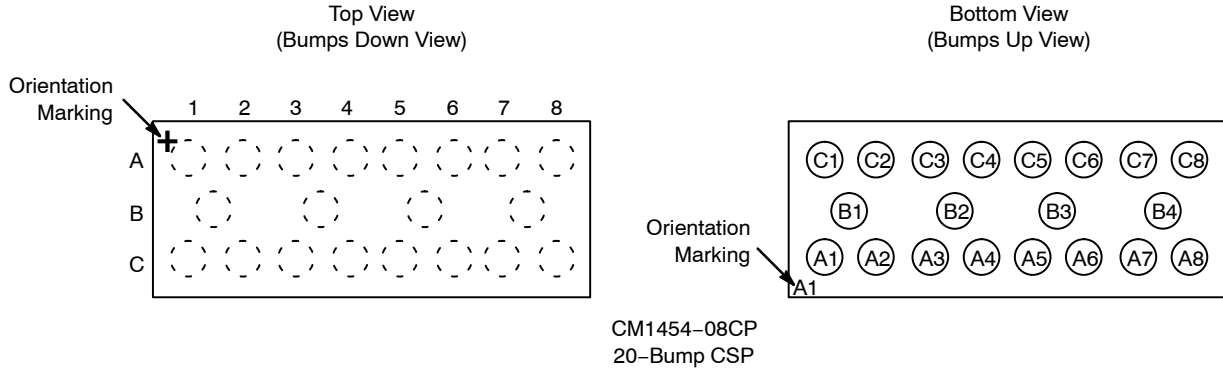

Figure 1. CM1454 Schematic Diagram of R-C and L-C Filter Arrays with ESD

# CM1454

## PACKAGE / PINOUT DIAGRAMS



**Table 1. PIN DESCRIPTIONS**

Pin Number	Pin Description	Pin Number	Pin Description
A1	Filter #1 (Microphone)	C1	Filter #1
A2	Filter #2 (Microphone)	C2	Filter #2
A3	Filter #3 (Stereo Headphone)	C3	Filter #3
A4	Filter #4 (Left Speaker)	C4	Filter #4
A5	Filter #5 (Right Speaker)	C5	Filter #5
A6	Filter #6 (Accessory ID)	C6	Filter #6
A7	Filter #7 (Data)	C7	Filter #7
A8	Filter #8 (Data)	C8	Filter #8
B1-B4	GND		

## SPECIFICATIONS

**Table 2. ABSOLUTE MAXIMUM RATINGS**

Parameter	Rating	Units
Storage Temperature Range	-65 to +150	°C
DC current per Inductor	30	mA
DC Package Power Rating	0.5	W

Stresses exceeding Maximum Ratings may damage the device. Maximum Ratings are stress ratings only. Functional operation above the Recommended Operating Conditions is not implied. Extended exposure to stresses above the Recommended Operating Conditions may affect device reliability.

**Table 3. STANDARD OPERATING CONDITIONS**

Parameter	Rating	Units
Operating Temperature Range	-40 to +85	°C

# CM1454

**Table 4. ELECTRICAL OPERATING CHARACTERISTICS** (Note 1)

Symbol	Parameter	Conditions	Min	Typ	Max	Units
R	Resistance		80	100	120	$\Omega$
C <sub>1</sub>	Capacitance	2.5 V dc; 1 MHz, 30 mV ac	24	30	36	pF
L	Inductance			3.0		nH
R <sub>E</sub>	Equivalent Series Resistance of Inductor			0.25		$\Omega$
C <sub>2</sub>	Capacitance	0 V dc, 1 MHz, 30 mV ac;	100	125	150	pF
		2.5 V dc, 1 MHz, 30 mV ac;	64	80	96	pF
f <sub>RC</sub>	Cut-off Frequency Z <sub>SOURCE</sub> = 50 $\Omega$ , Z <sub>LOAD</sub> = 50 $\Omega$			60		MHz
f <sub>LC</sub>	Cut-off Frequency Z <sub>SOURCE</sub> = 50 $\Omega$ , Z <sub>LOAD</sub> = 50 $\Omega$			21		MHz
V <sub>ST</sub>	Stand-off Voltage	I = 10 $\mu$ A		6.0		V
I <sub>LEAK</sub>	Diode Leakage Current	V <sub>IN</sub> = 3.3 V		0.1	1.0	$\mu$ A
V <sub>SIG</sub>	Signal Clamp Voltage	I <sub>LOAD</sub> = 10 mA I <sub>LOAD</sub> = -10 mA	5.6 -1.5	6.8 -0.8	9.0 -0.4	V
	Positive Clamp					
V <sub>ESD</sub>	In-system ESD Withstand Voltage	(Notes 2 and 3)	$\pm$ 30 $\pm$ 15			kV
	a) Human Body Model, MIL-STD-883, Method 3015 b) Contact Discharge per IEC 61000-4-2 Level 4					
R <sub>DYN</sub>	Dynamic Resistance			2.3 0.9		$\Omega$
	Positive					
	Negative					

1. T<sub>A</sub> = 25°C unless otherwise specified.
2. ESD applied to input and output pins with respect to GND, one at a time.
3. Unused pins are left open.

## PERFORMANCE INFORMATION

### Diode Characteristics (nominal conditions unless specified otherwise)

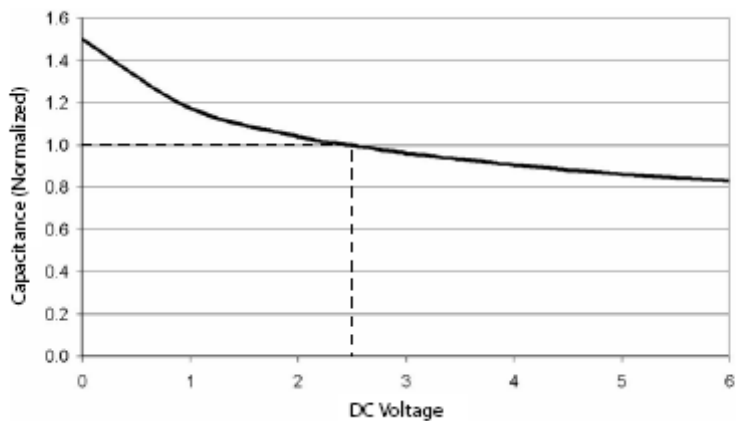

**Figure 2. Typical Diode Capacitance vs. Input Voltage (normalized to 2.5 VDC)**

# CM1454

## PERFORMANCE INFORMATION (Cont'd)

Typical Filter Performance (nominal conditions unless specified otherwise, 50 Ω Environment)

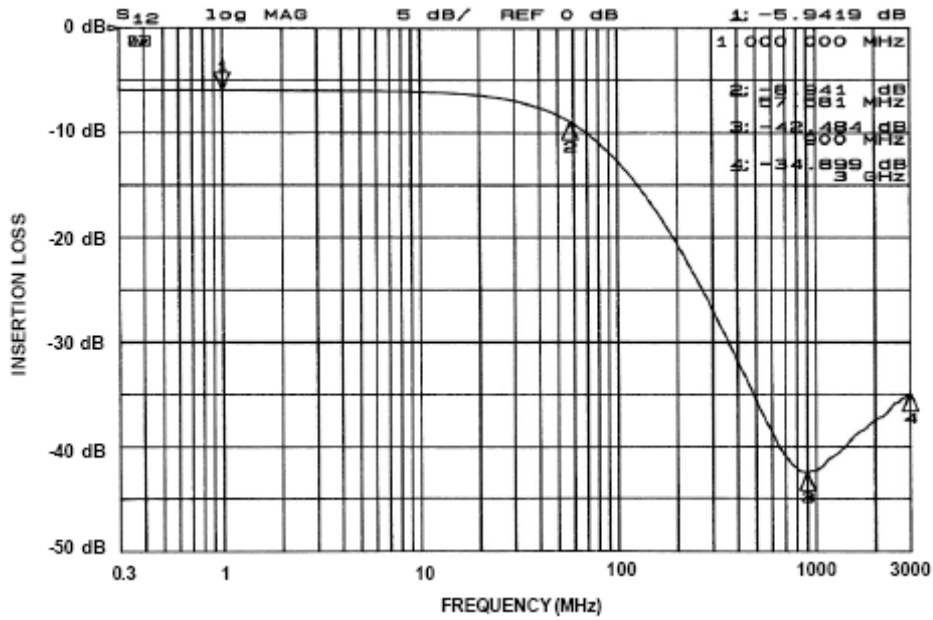

Figure 3. Attenuation Curve for CM1454 RC Filters: 1, 2, 6, 7, and 8

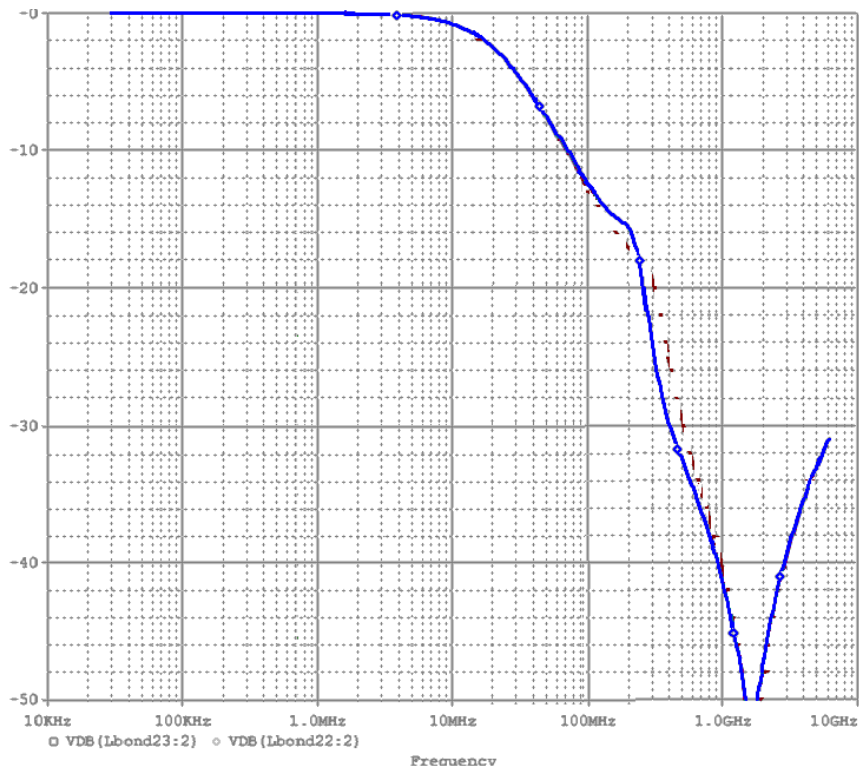

Figure 4. Attenuation Curve for CM1454 RC Filters: 3, 4, and 5

APPLICATION INFORMATION

Table 5. PRINTED CIRCUIT BOARD RECOMMENDATIONS

Parameter	Value
Pad Size on PCB	0.240 mm
Pad Shape	Round
Pad Definition	Non-Solder Mask defined pads
Solder Mask Opening	0.290 mm Round
Solder Stencil Thickness	0.125 – 0.150 mm
Solder Stencil Aperture Opening (laser cut, 5% tapered walls)	0.300 mm Round
Solder Flux Ratio	50/50 by volume
Solder Paste Type	No Clean
Pad Protective Finish	OSP (Entek Cu Plus 106A)
Tolerance – Edge To Corner Ball	±50 µm
Solder Ball Side Coplanarity	±20 µm
Maximum Dwell Time Above Liquidous	60 seconds
Maximum Soldering Temperature for Lead-free Devices using a Lead-free Solder Paste	260°C

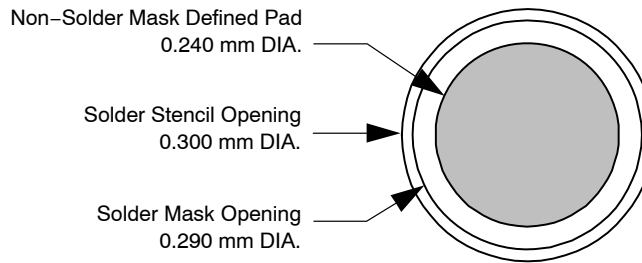

Figure 5. Recommended Non-Solder Mask Defined Pad Illustration

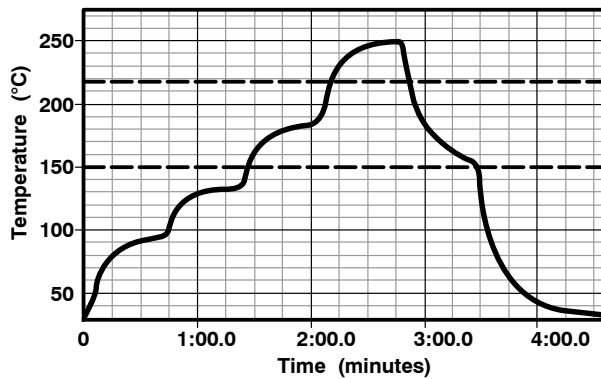

Figure 6. Lead-free (SnAgCu) Solder Ball Reflow Profile

# MECHANICAL CASE OUTLINE

## PACKAGE DIMENSIONS

ON Semiconductor®



**WLCSP20, 3.96x1.59**  
CASE 567BY-01  
ISSUE O

DATE 26 JUL 2010



SCALE 4:1

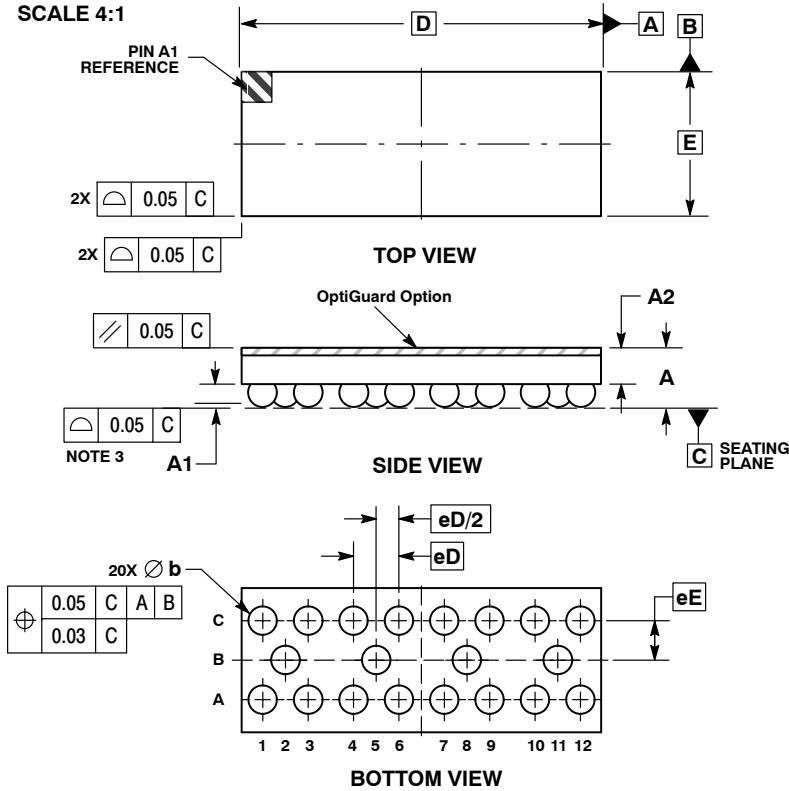

- NOTES:
1. DIMENSIONING AND TOLERANCING PER ASME Y14.5M, 1994.
  2. CONTROLLING DIMENSION: MILLIMETERS.
  3. COPLANARITY APPLIES TO SPHERICAL CROWNS OF SOLDER BALLS.

DIM	MILLIMETERS	
	MIN	MAX
A	0.56	0.72
A1	0.21	0.27
A2	0.42 REF	
b	0.29	0.35
D	3.96 BSC	
E	1.59 BSC	
eD	0.50 BSC	
eE	0.435 BSC	

### RECOMMENDED SOLDERING FOOTPRINT\*

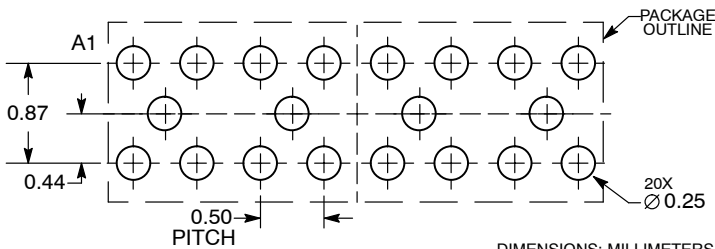

\*For additional information on our Pb-Free strategy and soldering details, please download the ON Semiconductor Soldering and Mounting Techniques Reference Manual, SOLDERRM/D.

<b>DOCUMENT NUMBER:</b>	<b>98AON49832E</b>	Electronic versions are uncontrolled except when accessed directly from the Document Repository. Printed versions are uncontrolled except when stamped "CONTROLLED COPY" in red.
<b>DESCRIPTION:</b>	<b>WLCSP20, 3.96X1.59</b>	<b>PAGE 1 OF 1</b>

ON Semiconductor and are trademarks of Semiconductor Components Industries, LLC dba ON Semiconductor or its subsidiaries in the United States and/or other countries. ON Semiconductor reserves the right to make changes without further notice to any products herein. ON Semiconductor makes no warranty, representation or guarantee regarding the suitability of its products for any particular purpose, nor does ON Semiconductor assume any liability arising out of the application or use of any product or circuit, and specifically disclaims any and all liability, including without limitation special, consequential or incidental damages. ON Semiconductor does not convey any license under its patent rights nor the rights of others.

**onsemi**, **Onsemi**, and other names, marks, and brands are registered and/or common law trademarks of Semiconductor Components Industries, LLC dba "**onsemi**" or its affiliates and/or subsidiaries in the United States and/or other countries. **onsemi** owns the rights to a number of patents, trademarks, copyrights, trade secrets, and other intellectual property. A listing of **onsemi**'s product/patent coverage may be accessed at [www.onsemi.com/site/pdf/Patent-Marking.pdf](http://www.onsemi.com/site/pdf/Patent-Marking.pdf). **onsemi** reserves the right to make changes at any time to any products or information herein, without notice. The information herein is provided "as-is" and **onsemi** makes no warranty, representation or guarantee regarding the accuracy of the information, product features, availability, functionality, or suitability of its products for any particular purpose, nor does **onsemi** assume any liability arising out of the application or use of any product or circuit, and specifically disclaims any and all liability, including without limitation special, consequential or incidental damages. Buyer is responsible for its products and applications using **onsemi** products, including compliance with all laws, regulations and safety requirements or standards, regardless of any support or applications information provided by **onsemi**. "Typical" parameters which may be provided in **onsemi** data sheets and/or specifications can and do vary in different applications and actual performance may vary over time. All operating parameters, including "Typicals" must be validated for each customer application by customer's technical experts. **onsemi** does not convey any license under any of its intellectual property rights nor the rights of others. **onsemi** products are not designed, intended, or authorized for use as a critical component in life support systems or any FDA Class 3 medical devices or medical devices with a same or similar classification in a foreign jurisdiction or any devices intended for implantation in the human body. Should Buyer purchase or use **onsemi** products for any such unintended or unauthorized application, Buyer shall indemnify and hold **onsemi** and its officers, employees, subsidiaries, affiliates, and distributors harmless against all claims, costs, damages, and expenses, and reasonable attorney fees arising out of, directly or indirectly, any claim of personal injury or death associated with such unintended or unauthorized use, even if such claim alleges that **onsemi** was negligent regarding the design or manufacture of the part. **onsemi** is an Equal Opportunity/Affirmative Action Employer. This literature is subject to all applicable copyright laws and is not for resale in any manner.

## ADDITIONAL INFORMATION

### TECHNICAL PUBLICATIONS:

Technical Library: [www.onsemi.com/design/resources/technical-documentation](http://www.onsemi.com/design/resources/technical-documentation)  
onsemi Website: [www.onsemi.com](http://www.onsemi.com)

### ONLINE SUPPORT: [www.onsemi.com/support](http://www.onsemi.com/support)

For additional information, please contact your local Sales Representative at [www.onsemi.com/support/sales](http://www.onsemi.com/support/sales)

