

2N6034G, 2N6035G, 2N6036G (PNP), 2N6038G, 2N6039G (NPN)



ON Semiconductor®

<http://onsemi.com>

Plastic Darlington Complementary Silicon Power Transistors

Plastic Darlington complementary silicon power transistors are designed for general purpose amplifier and low-speed switching applications.

Features

- ESD Ratings: Machine Model, C; > 400 V
Human Body Model, 3B; > 8000 V
- Epoxy Meets UL 94 V-0 @ 0.125 in
- These Devices are Pb-Free and are RoHS Compliant*

MAXIMUM RATINGS

Rating	Symbol	Value	Unit
Collector-Emitter Voltage 2N6034G 2N6035G, 2N6038G 2N6036G, 2N6039G	V_{CEO}	40 60 80	Vdc
Collector-Base Voltage 2N6034G 2N6035G, 2N6038G 2N6036G, 2N6039G	V_{CBO}	40 60 80	Vdc
Emitter-Base Voltage	V_{EBO}	5.0	Vdc
Collector Current - Continuous	I_C	4.0	Adc
Collector Current - Peak	I_{CM}	8.0	Apk
Base Current	I_B	100	mAdc
Total Device Dissipation @ $T_C = 25^\circ\text{C}$ Derate above 25°C	P_D	40 320	W mW/ $^\circ\text{C}$
Total Device Dissipation @ $T_C = 25^\circ\text{C}$ Derate above 25°C	P_D	1.5 12	W mW/ $^\circ\text{C}$
Operating and Storage Junction Temperature Range	T_J, T_{stg}	-65 to +150	$^\circ\text{C}$

Stresses exceeding those listed in the Maximum Ratings table may damage the device. If any of these limits are exceeded, device functionality should not be assumed, damage may occur and reliability may be affected.

THERMAL CHARACTERISTICS

Characteristic	Symbol	Max	Unit
Thermal Resistance, Junction-to-Case	$R_{\theta JC}$	3.12	$^\circ\text{C}/\text{W}$
Thermal Resistance, Junction-to-Ambient	$R_{\theta JA}$	83.3	$^\circ\text{C}/\text{W}$

*For additional information on our Pb-Free strategy and soldering details, please download the ON Semiconductor Soldering and Mounting Techniques Reference Manual, SOLDERRM/D.

4.0 AMPERES DARLINGTON COMPLEMENTARY SILICON POWER TRANSISTORS 40, 60, 80 VOLTS, 40 WATTS

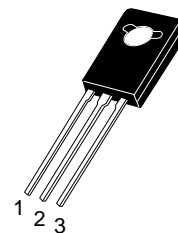
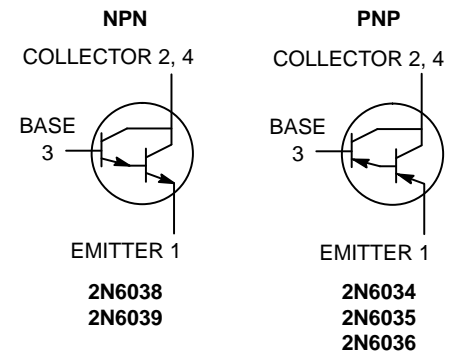

TO-225
CASE 77-09
STYLE 1

MARKING DIAGRAM

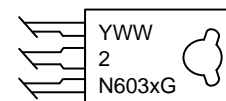

Y = Year
WW = Work Week
2N603x = Device Code
x = 4, 5, 6, 8, 9
G = Pb-Free Package

ORDERING INFORMATION

See detailed ordering and shipping information in the package dimensions section on page 5 of this data sheet.

2N6034G, 2N6035G, 2N6036G (PNP), 2N6038G, 2N6039G (NPN)

ELECTRICAL CHARACTERISTICS (T_C = 25°C unless otherwise noted)

Characteristic	Symbol	Min	Max	Unit
OFF CHARACTERISTICS				
Collector–Emitter Sustaining Voltage (I _C = 100 mAdc, I _B = 0) 2N6034G 2N6035G, 2N6038G 2N6036G, 2N6039G	V _{CEO(sus)}	40 60 80	– – –	Vdc
Collector–Cutoff Current (V _{CE} = 40 Vdc, I _B = 0) 2N6034G (V _{CE} = 60 Vdc, I _B = 0) 2N6035G, 2N6038G (V _{CE} = 80 Vdc, I _B = 0) 2N6036G, 2N6039G	I _{CEO}	– – –	100 100 100	μA
Collector–Cutoff Current (V _{CE} = 40 Vdc, V _{BE(off)} = 1.5 Vdc) 2N6034G (V _{CE} = 60 Vdc, V _{BE(off)} = 1.5 Vdc) 2N6035G, 2N6038G (V _{CE} = 80 Vdc, V _{BE(off)} = 1.5 Vdc) 2N6036G, 2N6039G (V _{CE} = 40 Vdc, V _{BE(off)} = 1.5 Vdc, T _C = 125°C) 2N6034G (V _{CE} = 60 Vdc, V _{BE(off)} = 1.5 Vdc, T _C = 125°C) 2N6035G, 2N6038G (V _{CE} = 80 Vdc, V _{BE(off)} = 1.5 Vdc, T _C = 125°C) 2N6036G, 2N6039G	I _{CEX}	– – – – – –	100 100 100 500 500 500	μA
Collector–Cutoff Current (V _{CB} = 40 Vdc, I _E = 0) 2N6034G (V _{CB} = 60 Vdc, I _E = 0) 2N6035G, 2N6038G (V _{CB} = 80 Vdc, I _E = 0) 2N6036G, 2N6039G	I _{CBO}	– – –	0.5 0.5 0.5	mAdc
Emitter–Cutoff Current (V _{BE} = 5.0 Vdc, I _C = 0)	I _{EBO}	–	2.0	mAdc
ON CHARACTERISTICS				
DC Current Gain (I _C = 0.5 Adc, V _{CE} = 3.0 Vdc) (I _C = 2.0 Adc, V _{CE} = 3.0 Vdc) (I _C = 4.0 Adc, V _{CE} = 3.0 Vdc)	h _{FE}	500 750 100	– 15,000 –	–
Collector–Emitter Saturation Voltage (I _C = 2.0 Adc, I _B = 8.0 mAdc) (I _C = 4.0 Adc, I _B = 40 mAdc)	V _{CE(sat)}	– –	2.0 3.0	Vdc
Base–Emitter Saturation Voltage (I _C = 4.0 Adc, I _B = 40 mAdc)	V _{BE(sat)}	–	4.0	Vdc
Base–Emitter On Voltage (I _C = 2.0 Adc, V _{CE} = 3.0 Vdc)	V _{BE(on)}	–	2.8	Vdc
DYNAMIC CHARACTERISTICS				
Small–Signal Current–Gain (I _C = 0.75 Adc, V _{CE} = 10 Vdc, f = 1.0 MHz)	h _{fe}	25	–	–
Output Capacitance (V _{CB} = 10 Vdc, I _E = 0, f = 0.1 MHz) 2N6034G, 2N6035G, 2N6036G 2N6038G, 2N6039G	C _{ob}	– –	200 100	pF

Product parametric performance is indicated in the Electrical Characteristics for the listed test conditions, unless otherwise noted. Product performance may not be indicated by the Electrical Characteristics if operated under different conditions.

*Indicates JEDEC Registered Data.

2N6034G, 2N6035G, 2N6036G (PNP), 2N6038G, 2N6039G (NPN)

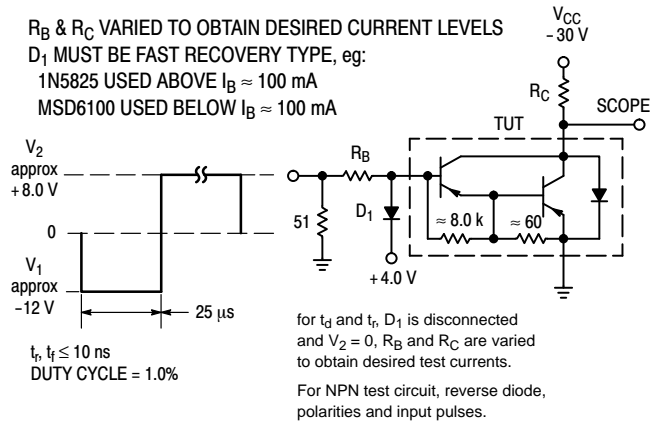

Figure 1. Switching Times Test Circuit

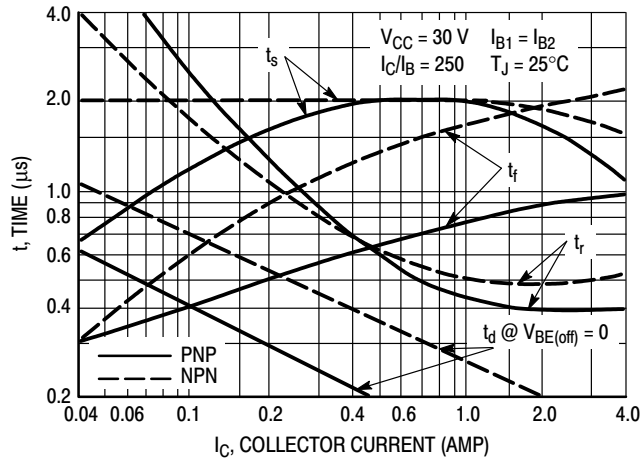

Figure 2. Switching Times

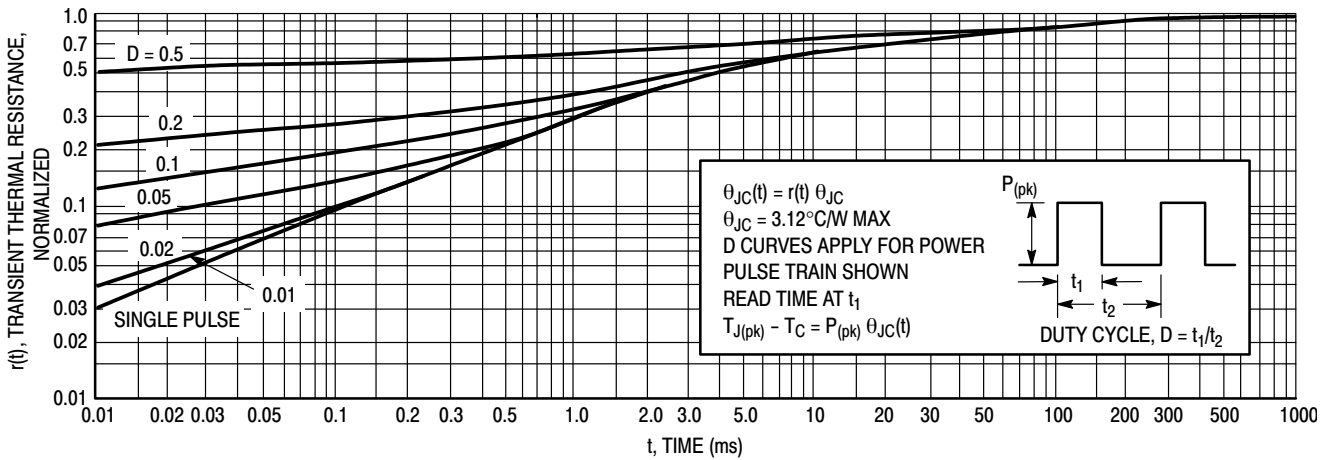

Figure 3. Thermal Response

2N6034G, 2N6035G, 2N6036G (PNP), 2N6038G, 2N6039G (NPN)

ACTIVE-REGION SAFE-OPERATING AREA

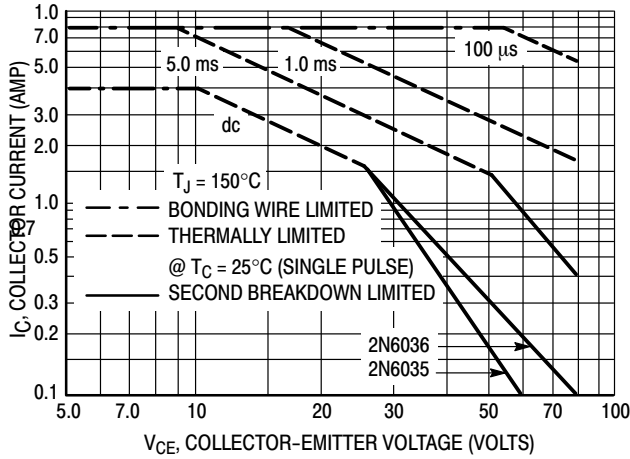

Figure 4. 2N6035, 2N6036

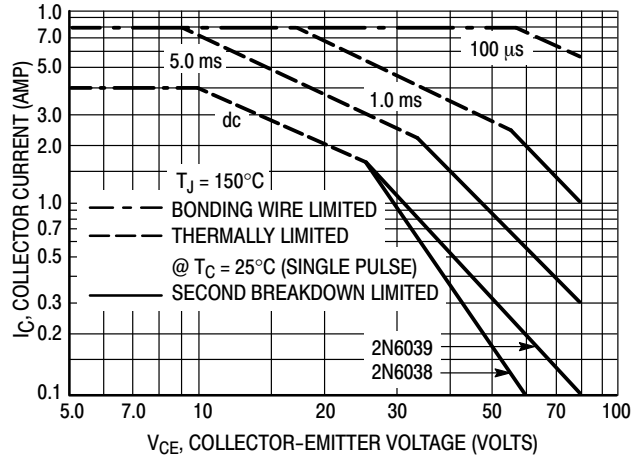

Figure 5. 2N6038, 2N6039

There are two limitations on the power handling ability of a transistor: average junction temperature and second breakdown. Safe operating area curves indicate $I_C - V_{CE}$ limits of the transistor that must be observed for reliable operation; i.e., the transistor must not be subjected to greater dissipation than the curves indicate.

The data of Figures 4 and 5 is based on $T_{J(pk)} = 150^\circ\text{C}$; T_C is variable depending on conditions. Second breakdown pulse limits are valid for duty cycles to 10% provided $T_{J(pk)} < 150^\circ\text{C}$. $T_{J(pk)}$ may be calculated from the data in Figure 3. At high case temperatures, thermal limitations will reduce the power that can be handled to values less than the limitations imposed by second breakdown.

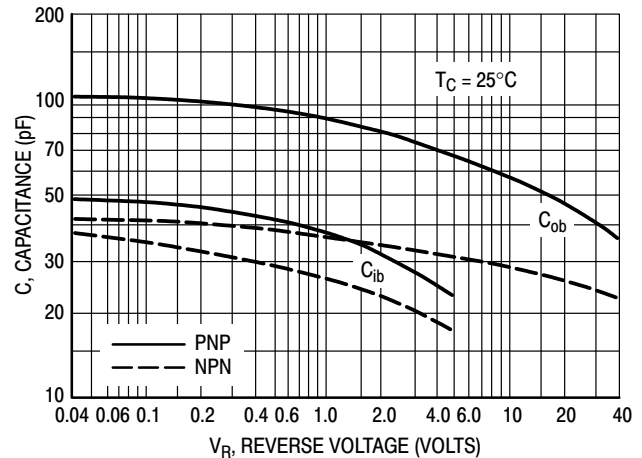
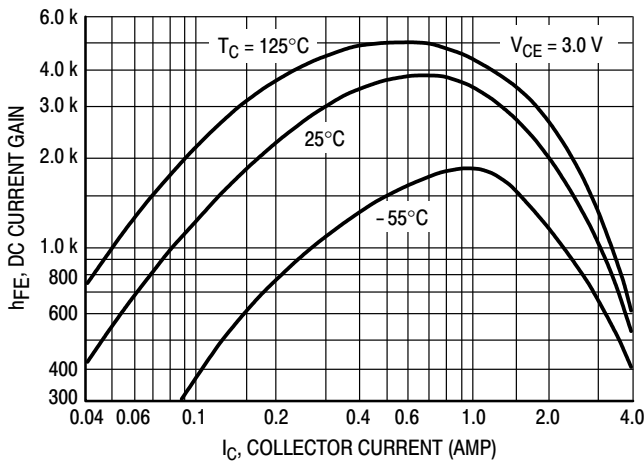

Figure 6. Capacitance

PNP 2N6034, 2N6035, 2N6036



NPN 2N6038, 2N6039

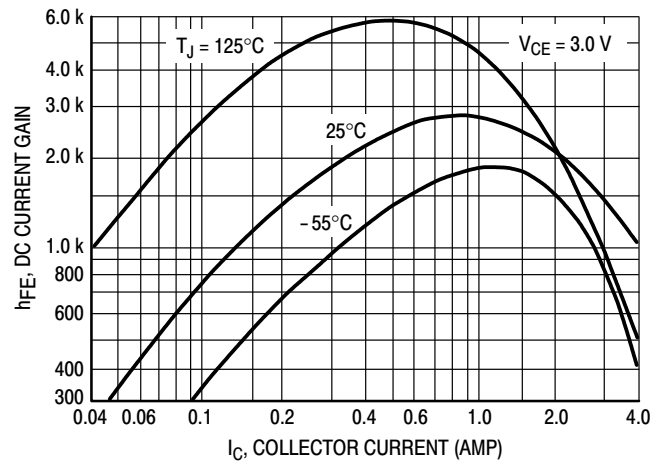

Figure 7. DC Current Gain

2N6034G, 2N6035G, 2N6036G (PNP), 2N6038G, 2N6039G (NPN)

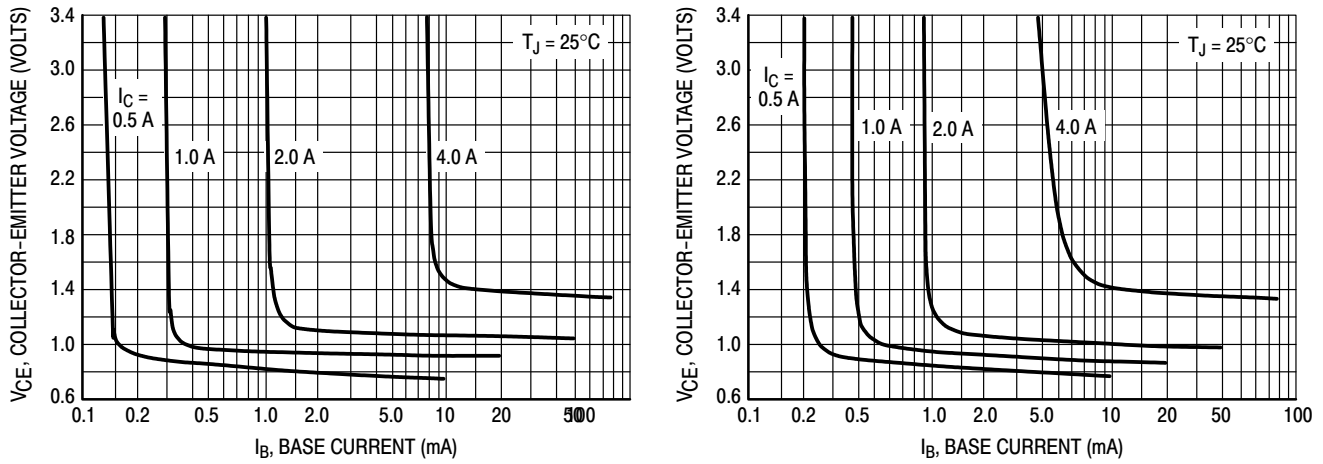

Figure 8. Collector Saturation Region

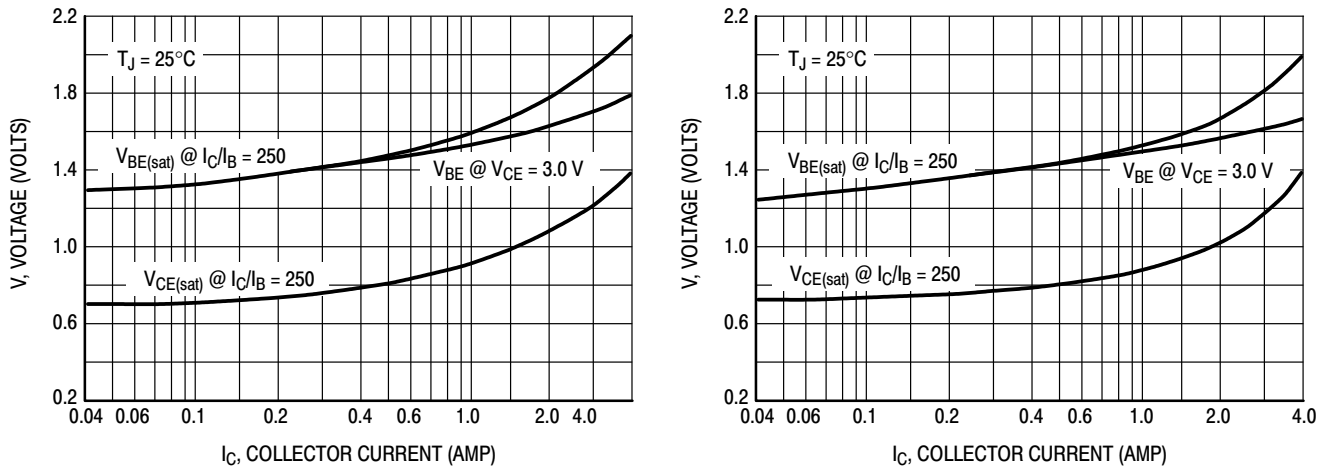

Figure 9. "On" Voltages

ORDERING INFORMATION

Device	Package	Shipping
2N6034G	TO-225 (Pb-Free)	500 Units / Box
2N6035G	TO-225 (Pb-Free)	500 Units / Box
2N6036G	TO-225 (Pb-Free)	500 Units / Box
2N6038G	TO-225 (Pb-Free)	500 Units / Box
2N6039G	TO-225 (Pb-Free)	500 Units / Box

MECHANICAL CASE OUTLINE

PACKAGE DIMENSIONS

ON Semiconductor®

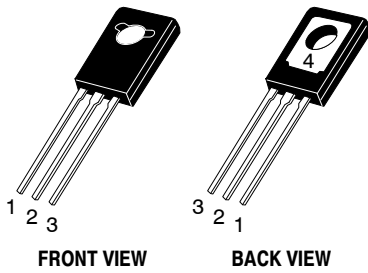

TO-225
CASE 77-09
ISSUE AD

DATE 25 MAR 2015

SCALE 1:1

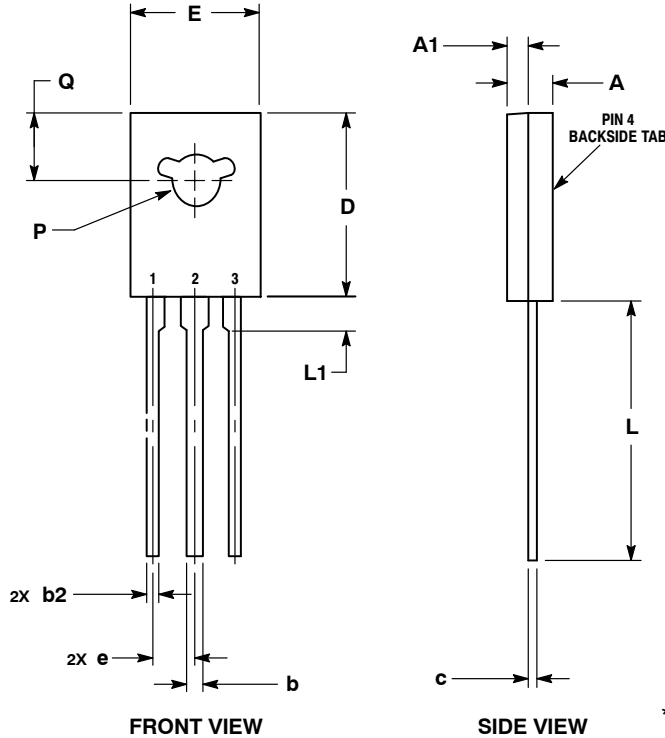

NOTES:

1. DIMENSIONING AND TOLERANCING PER ASME Y14.5M, 1994.
2. CONTROLLING DIMENSION: MILLIMETERS.
3. NUMBER AND SHAPE OF LUGS OPTIONAL.

DIM	MILLIMETERS	
	MIN	MAX
A	2.40	3.00
A1	1.00	1.50
b	0.60	0.90
b2	0.51	0.88
c	0.39	0.63
D	10.60	11.10
E	7.40	7.80
e	2.04	2.54
L	14.50	16.63
L1	1.27	2.54
P	2.90	3.30
Q	3.80	4.20

GENERIC MARKING DIAGRAM*

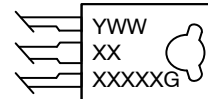

- Y = Year
- WW = Work Week
- XXXXX = Device Code
- G = Pb-Free Package

*This information is generic. Please refer to device data sheet for actual part marking. Pb-Free indicator, "G" or microdot "µ", may or may not be present.

- | | | | | |
|---|---|---|---|---|
| <p>STYLE 1:
PIN 1. EMITTER
2., 4. COLLECTOR
3. BASE</p> | <p>STYLE 2:
PIN 1. CATHODE
2., 4. ANODE
3. GATE</p> | <p>STYLE 3:
PIN 1. BASE
2., 4. COLLECTOR
3. EMITTER</p> | <p>STYLE 4:
PIN 1. ANODE 1
2., 4. ANODE 2
3. GATE</p> | <p>STYLE 5:
PIN 1. MT 1
2., 4. MT 2
3. GATE</p> |
| <p>STYLE 6:
PIN 1. CATHODE
2., 4. GATE
3. ANODE</p> | <p>STYLE 7:
PIN 1. MT 1
2., 4. GATE
3. MT 2</p> | <p>STYLE 8:
PIN 1. SOURCE
2., 4. GATE
3. DRAIN</p> | <p>STYLE 9:
PIN 1. GATE
2., 4. DRAIN
3. SOURCE</p> | <p>STYLE 10:
PIN 1. SOURCE
2., 4. DRAIN
3. GATE</p> |

DOCUMENT NUMBER:	98ASB42049B	Electronic versions are uncontrolled except when accessed directly from the Document Repository. Printed versions are uncontrolled except when stamped "CONTROLLED COPY" in red.
DESCRIPTION:	TO-225	PAGE 1 OF 1

ON Semiconductor and are trademarks of Semiconductor Components Industries, LLC dba ON Semiconductor or its subsidiaries in the United States and/or other countries. ON Semiconductor reserves the right to make changes without further notice to any products herein. ON Semiconductor makes no warranty, representation or guarantee regarding the suitability of its products for any particular purpose, nor does ON Semiconductor assume any liability arising out of the application or use of any product or circuit, and specifically disclaims any and all liability, including without limitation special, consequential or incidental damages. ON Semiconductor does not convey any license under its patent rights nor the rights of others.

onsemi, **Onsemi**, and other names, marks, and brands are registered and/or common law trademarks of Semiconductor Components Industries, LLC dba "**onsemi**" or its affiliates and/or subsidiaries in the United States and/or other countries. **onsemi** owns the rights to a number of patents, trademarks, copyrights, trade secrets, and other intellectual property. A listing of **onsemi**'s product/patent coverage may be accessed at www.onsemi.com/site/pdf/Patent-Marking.pdf. **onsemi** reserves the right to make changes at any time to any products or information herein, without notice. The information herein is provided "as-is" and **onsemi** makes no warranty, representation or guarantee regarding the accuracy of the information, product features, availability, functionality, or suitability of its products for any particular purpose, nor does **onsemi** assume any liability arising out of the application or use of any product or circuit, and specifically disclaims any and all liability, including without limitation special, consequential or incidental damages. Buyer is responsible for its products and applications using **onsemi** products, including compliance with all laws, regulations and safety requirements or standards, regardless of any support or applications information provided by **onsemi**. "Typical" parameters which may be provided in **onsemi** data sheets and/or specifications can and do vary in different applications and actual performance may vary over time. All operating parameters, including "Typicals" must be validated for each customer application by customer's technical experts. **onsemi** does not convey any license under any of its intellectual property rights nor the rights of others. **onsemi** products are not designed, intended, or authorized for use as a critical component in life support systems or any FDA Class 3 medical devices or medical devices with a same or similar classification in a foreign jurisdiction or any devices intended for implantation in the human body. Should Buyer purchase or use **onsemi** products for any such unintended or unauthorized application, Buyer shall indemnify and hold **onsemi** and its officers, employees, subsidiaries, affiliates, and distributors harmless against all claims, costs, damages, and expenses, and reasonable attorney fees arising out of, directly or indirectly, any claim of personal injury or death associated with such unintended or unauthorized use, even if such claim alleges that **onsemi** was negligent regarding the design or manufacture of the part. **onsemi** is an Equal Opportunity/Affirmative Action Employer. This literature is subject to all applicable copyright laws and is not for resale in any manner.

ADDITIONAL INFORMATION

TECHNICAL PUBLICATIONS:

Technical Library: www.onsemi.com/design/resources/technical-documentation
onsemi Website: www.onsemi.com

ONLINE SUPPORT: www.onsemi.com/support

For additional information, please contact your local Sales Representative at www.onsemi.com/support/sales