

ON Semiconductor

Is Now

The logo for onsemi, featuring the word "onsemi" in a dark teal, lowercase, sans-serif font. The letter "i" is stylized with a white dot and a teal vertical bar. A small orange triangle is positioned above the top right of the "i". A trademark symbol (TM) is located to the right of the logo.

To learn more about onsemi™, please visit our website at
www.onsemi.com

onsemi and **onsemi** and other names, marks, and brands are registered and/or common law trademarks of Semiconductor Components Industries, LLC dba "**onsemi**" or its affiliates and/or subsidiaries in the United States and/or other countries. **onsemi** owns the rights to a number of patents, trademarks, copyrights, trade secrets, and other intellectual property. A listing of **onsemi** product/patent coverage may be accessed at www.onsemi.com/site/pdf/Patent-Marking.pdf. **onsemi** reserves the right to make changes at any time to any products or information herein, without notice. The information herein is provided "as-is" and **onsemi** makes no warranty, representation or guarantee regarding the accuracy of the information, product features, availability, functionality, or suitability of its products for any particular purpose, nor does **onsemi** assume any liability arising out of the application or use of any product or circuit, and specifically disclaims any and all liability, including without limitation special, consequential or incidental damages. Buyer is responsible for its products and applications using **onsemi** products, including compliance with all laws, regulations and safety requirements or standards, regardless of any support or applications information provided by **onsemi**. "Typical" parameters which may be provided in **onsemi** data sheets and/or specifications can and do vary in different applications and actual performance may vary over time. All operating parameters, including "Typicals" must be validated for each customer application by customer's technical experts. **onsemi** does not convey any license under any of its intellectual property rights nor the rights of others. **onsemi** products are not designed, intended, or authorized for use as a critical component in life support systems or any FDA Class 3 medical devices or medical devices with a same or similar classification in a foreign jurisdiction or any devices intended for implantation in the human body. Should Buyer purchase or use **onsemi** products for any such unintended or unauthorized application, Buyer shall indemnify and hold **onsemi** and its officers, employees, subsidiaries, affiliates, and distributors harmless against all claims, costs, damages, and expenses, and reasonable attorney fees arising out of, directly or indirectly, any claim of personal injury or death associated with such unintended or unauthorized use, even if such claim alleges that **onsemi** was negligent regarding the design or manufacture of the part. **onsemi** is an Equal Opportunity/Affirmative Action Employer. This literature is subject to all applicable copyright laws and is not for resale in any manner. Other names and brands may be claimed as the property of others.

NCV887103 340 kHz Automotive SEPIC Reference Design

TND6344/D

Overview

This reference design describes the operation and performance of the NCV887103 automotive boost/SEPIC controller with a NVTFS5C478NL 40 V single N-channel FET. The design demonstrates the NCV887103 controller capabilities as well as a complete designed for an automotive pre-regulator for broad range of applications.

It is intended for the power supply designer to adopt the circuit directly into a typical system design, making only minimal component changes based on system requirements.

The design is meant to be a complete solution, but it also provides access to key features of the NCV887103. These include peak current mode control with internal slope compensation, 1.2 V \pm 2% reference voltage, fixed frequency operation, wide input voltage range, input undervoltage lockout, internal soft-start, low IQ in sleep mode, cycle-by-cycle current limit protection, hiccup-mode overcurrent protection, hiccup-mode short-circuit protection and thermal shutdown.

Key Features

- Complete Automotive Reference Design
- Non-synchronous SEPIC Controller with an Input Voltage Range of 6.0 V to 16.0 V, Handles Peaks up to 40 V
- 340 kHz Switching Frequency for Maximum Efficiency
- ON Semiconductor NCV887103 Adjustable Output Automotive Non-synchronous SEPIC Controller and NVTFS5C478NL 40 V Single N-channel FET
- Small Form Factor PCB with Two Layers

Specifications

Table 1. SPECIFICATIONS TABLE

Device	NCV887103
Application	Automotive Rear Lighting SEPIC Application
Input Voltage	6.0 V to 16.0 Vdc
Output Power	Up to 10 W
Topology	SEPIC
Isolation	Non-Isolated
Output Voltage	11.5 V
Output Current	0.9 A



ON Semiconductor®

www.onsemi.com

REFERENCE DESIGN

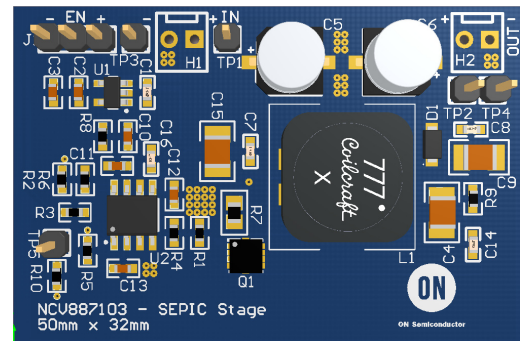

Figure 1. Reference Design PCB Print

SCHEMATICS

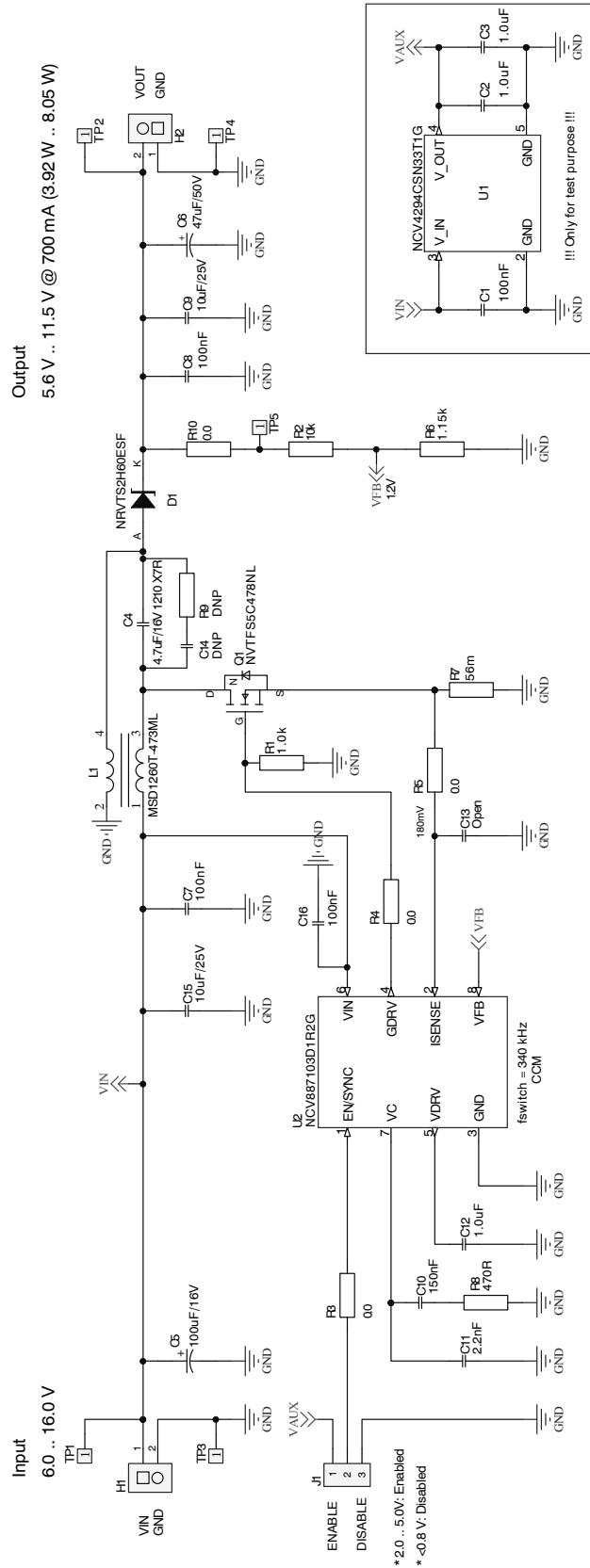

Figure 2. NCV887103 SEPIC Schematic

TND6344/D

BOARD LAYOUT

Figure 3 and 4 show the top and bottom assembly and the two layers of the PCB. The PCB is 50 mm x 32 mm (length x width).

The power stage is located only at one side of the PCB with short traces and minimized numbers of vias in order to reduce parasitic influences.

The power GND and analog GND are only connected at the IC GND pad to separate both ground planes.

Five test pins allow the measurement of the in- and output, the phase and gain margin.

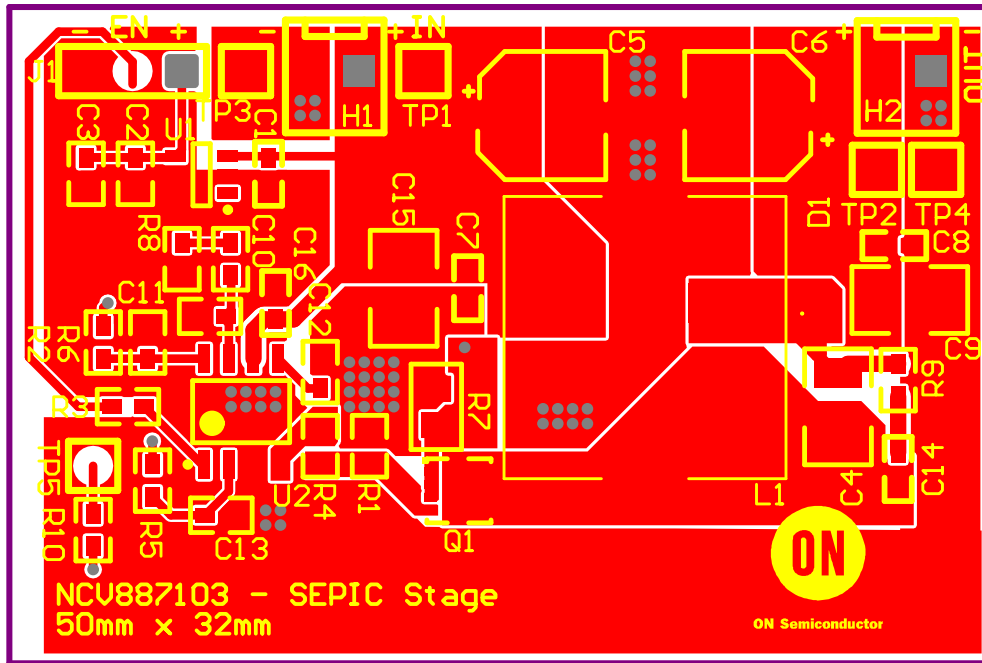

Figure 3. Top Layer with Assemble Drawing

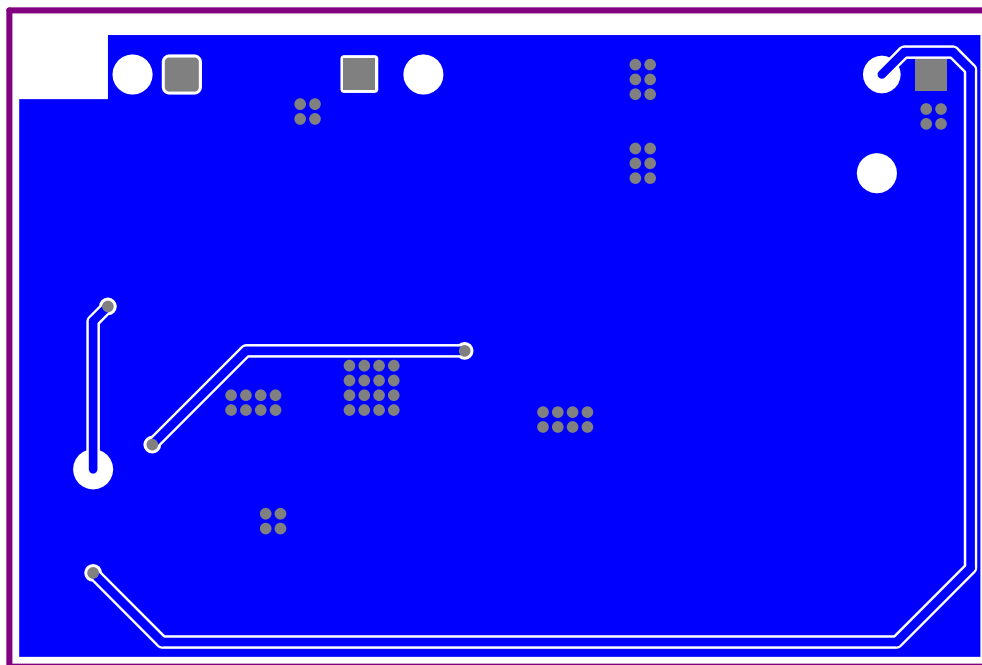

Figure 4. Bottom Layer with Assemble Drawing

PERFORMANCE SUMMARY

Efficiency

The efficiency for continuous mode is shown in Figure 5.

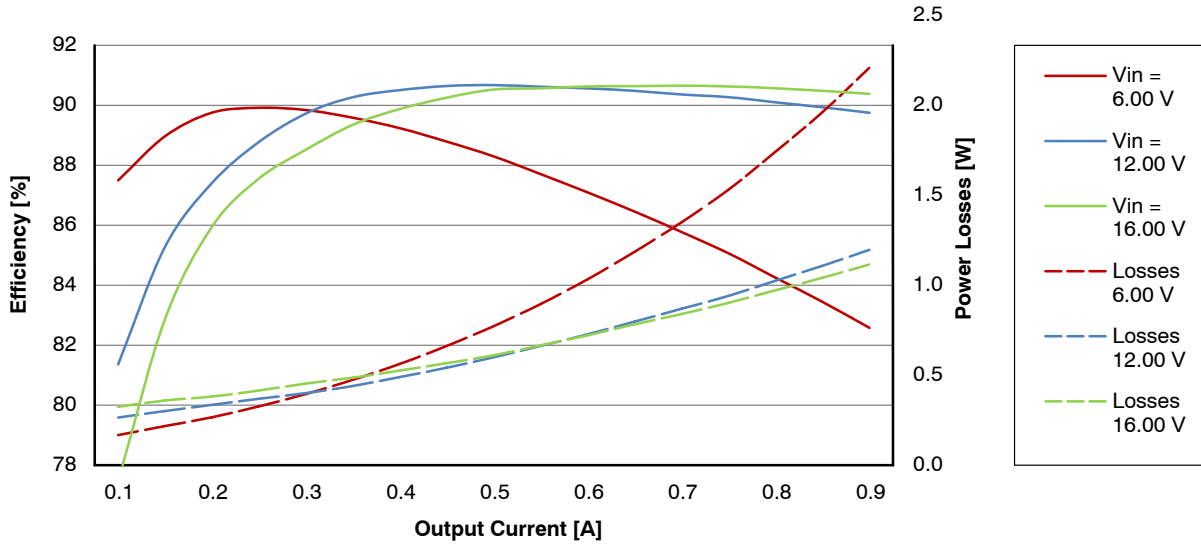

Figure 5. Efficiency for 6.0, 12.0 and 16.0 V Input Voltage

Transient Response

The response to a load step from 0.3 A to 0.6 A and vice versa at 12.0 V input voltage is shown in Figure 6.

- Channel 1: Output current, load step 0.3 to 0.6 A 0.2 A/div, 1 ms/div
- Channel 2: Output voltage, approx. -200 mV (-1.7 %) undershoot, approx. +200 mV (1.7%) overshoot 200 mV/div, 1 ms/div, AC coupled

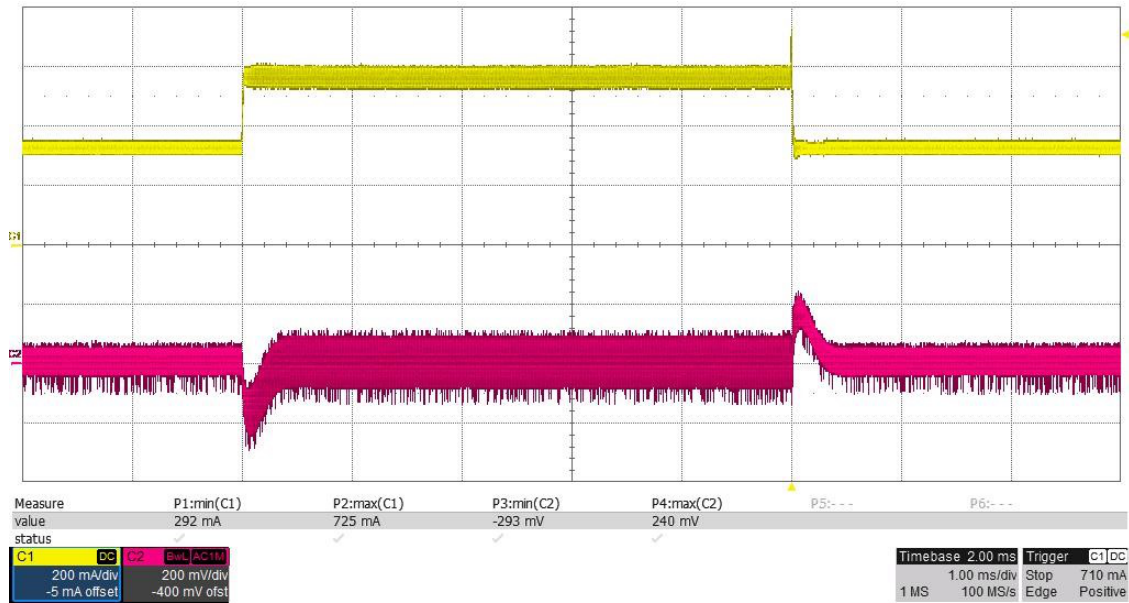

Figure 6. Transient Response on 0.3 A Load Step

Frequency Response

The frequency response at 12.0 V input voltage and 0.8 A load is shown in Figure 7.

The purpose of R10 (see Figure 2) is to provide access to measure the gain and phase of the PCB with the bode analyzer. Both pins of the analyzer are connected to TP2 and TP5 using a load of 50 Ω for R10.

- Trace 1:
 - ◆ 3.26 kHz bandwidth
 - ◆ -11.9 dB gain margin
- Trace 2:
 - ◆ 74° phase margin

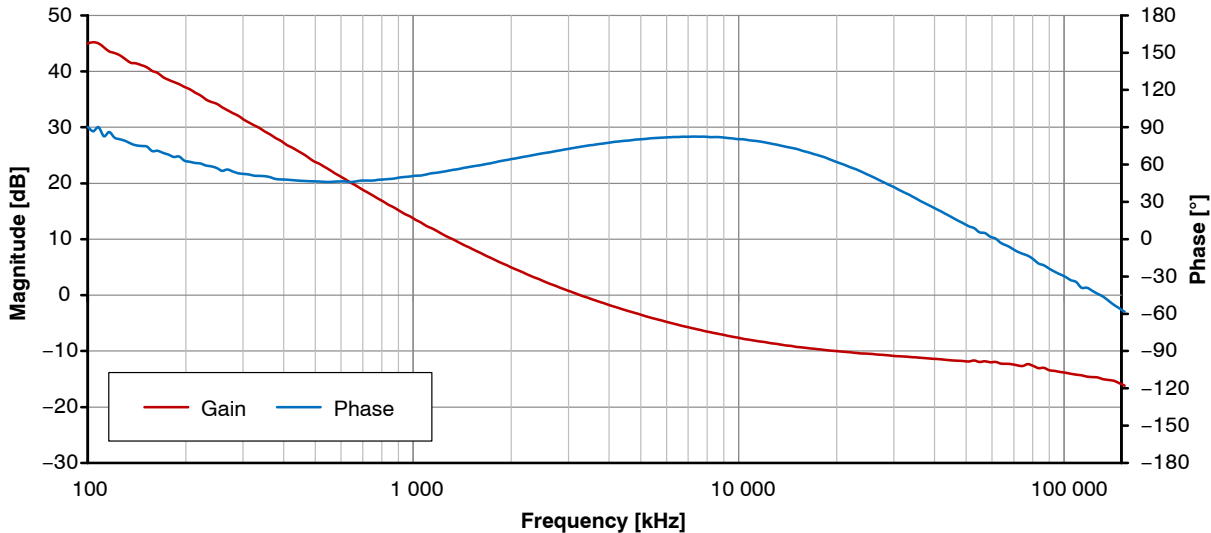

Figure 7. Frequency Response at 0.8 A Load

Table 2. FREQUENCY RESPONSE AT 0.8 A LOAD

	Bandwidth [kHz]	Gain Margin [dB]	Phase Margin [°]
V _{IN} = 6 V	2.01	-8.5	52
V _{IN} = 12 V	3.26	-11.9	74
V _{IN} = 16 V	3.73	-11.5	81

TND6344/D

BILL OF MATERIALS (BOM)

Table 3. BILL OF MATERIALS

Designator	Qty.	Value	Part Number	Manufacturer	Description	Package
C1, C7, C8, C16	4	100 nF	GCM188R71H104KA57D	Murata	CAP, CERM, 100 nF, 50 V, ±10%, X7R, 0603	0603
C2, C3, C12	3	1 µF	GRT188R61H105KE13D	Murata	CAP, CERM, 1 µF, 50 V, ±10%, X7R, 0603	0603
C4	1	4.7 µF	GCM31CR71E475KA55K	Murata	CAP, CERM, 4.7 µF, 25 V, ±10%, X7R, 1210	1210
C5	1	100 µF	UCM1E101MCL1GS	Nichicon	CAP, Electrolyte, 100 µF, 25 V, ±20%, SMD	D6.3 x L5.8 mm
C6	1	47 µF	GYB1H330MCQ1GS	Nichicon	CAP, Hybrid, 33 µF, 50 V, 100 µF, 50 V, ±20%, SMD	D6.3 x L7.7 mm
C9, C15	2	10 µF	GCM32ER71E106KA57K	Murata	CAP, CERM, 10 µF, 25 V, ±10%, X7R, 1210	1210
C10	1	150 nF	GCM188R71H154KA64D	Murata	CAP, CERM, 150 nF, 50 V, ±10%, X7R, 0603	0603
C11	1	2.2 nF	GCN188R71H222KA37D	Murata	CAP, CERM, 2.2 nF, 50 V, ±10%, X7R, 0603	0603
C13	1	DNP				
C14	1	DNP				
D1	1	60 V	NRVTS2H60ESF	ON Semiconductor	Diode, Schottky, 60 V, 2 A, AEC-Q101, SOD-123FL	SOD-123FL
H1, H2	2					
J1	1		61330311121	Wurth Elektronik	Header, 2.54 mm, 3x1, Gold, TH	Header, 2.54 mm, 3x1, TH
L1	1	47 µH	MSD1260T-473ML	Coilcraft	Inductor, Coupled, Composite, 47 µH, 3.4 A, 12.3 x 12.3 mm, SMD	12.3 x 12.3
Q1	1	40 V	NVTFS5C478NL	ON Semiconductor	MOSFET, 1-CH, N-CH, 40 V, 26 A, µ8FL 3x3	µ8FL
R1	1	1 kΩ	CRCW06031K00FKEA	Vishay-Dale	RES, 1 kΩ, 1%, 0.1 W, 0603	0603
R2	1	10 kΩ	CRCW060310K0FKEA	Vishay-Dale	RES, 10 kΩ, 1%, 0.1 W, 0603	0603
R3, R4, R5, R10	4	0 Ω	CRCW06030000Z0EA	Vishay-Dale	RES, 0 Ω, 5%, 0.1 W, 0603	0603
R6	1	1.15 kΩ	CRCW060331K15FKEA	Vishay-Dale	RES, 1.15 kΩ, 1%, 0.1 W, 0603	0603
R7	1	56 mΩ	ERJ-6BWJR056V	Panasonic	RES, 56 mΩ, 5%, 0.5 W, 0805	0805
R8	1	470 Ω	CRCW0603470RFKEA	Vishay-Dale	RES, 470 Ω, 1%, 0.1 W, 0603	0603
R9	1	DNP				
TP1, TP2, TP3, TP4, TP5	5		5000	Keystone	Test Point, Miniature, Red, TH	Red Miniature Testpoint
U1	1		NCV4294CSN33T1G	ON Semiconductor	LDO Regulator, 30 mA, Ultra-Low Dropout	TSOP-5
U2	1		NCV887103D1R2G	ON Semiconductor	Automotive Grade Non-Synchronous Boost Controller	SOIC-8

ON Semiconductor and  are trademarks of Semiconductor Components Industries, LLC dba ON Semiconductor or its subsidiaries in the United States and/or other countries. ON Semiconductor owns the rights to a number of patents, trademarks, copyrights, trade secrets, and other intellectual property. A listing of ON Semiconductor's product/patent coverage may be accessed at www.onsemi.com/site/pdf/Patent-Marking.pdf. ON Semiconductor reserves the right to make changes without further notice to any products herein. ON Semiconductor makes no warranty, representation or guarantee regarding the suitability of its products for any particular purpose, nor does ON Semiconductor assume any liability arising out of the application or use of any product or circuit, and specifically disclaims any and all liability, including without limitation special, consequential or incidental damages. Buyer is responsible for its products and applications using ON Semiconductor products, including compliance with all laws, regulations and safety requirements or standards, regardless of any support or applications information provided by ON Semiconductor. "Typical" parameters which may be provided in ON Semiconductor data sheets and/or specifications can and do vary in different applications and actual performance may vary over time. All operating parameters, including "Typicals" must be validated for each customer application by customer's technical experts. ON Semiconductor does not convey any license under its patent rights nor the rights of others. ON Semiconductor products are not designed, intended, or authorized for use as a critical component in life support systems or any FDA Class 3 medical devices or medical devices with a same or similar classification in a foreign jurisdiction or any devices intended for implantation in the human body. Should Buyer purchase or use ON Semiconductor products for any such unintended or unauthorized application, Buyer shall indemnify and hold ON Semiconductor and its officers, employees, subsidiaries, affiliates, and distributors harmless against all claims, costs, damages, and expenses, and reasonable attorney fees arising out of, directly or indirectly, any claim of personal injury or death associated with such unintended or unauthorized use, even if such claim alleges that ON Semiconductor was negligent regarding the design or manufacture of the part. ON Semiconductor is an Equal Opportunity/Affirmative Action Employer. This literature is subject to all applicable copyright laws and is not for resale in any manner.

PUBLICATION ORDERING INFORMATION

LITERATURE FULFILLMENT:
Email Requests to: orderlit@onsemi.com

TECHNICAL SUPPORT
North American Technical Support:
 Voice Mail: 1 800-282-9855 Toll Free USA/Canada
 Phone: 011 421 33 790 2910

Europe, Middle East and Africa Technical Support:
 Phone: 00421 33 790 2910
 For additional information, please contact your local Sales Representative